

Application Technique

Supply System

Valid from 1 November 2013

**KNOW
HOW**
INSTALLED

Legal Information

System design / dimension data

This document contains only general, technical information. The design of Geberit Mapress, especially the dimensions, must be drawn up and calculated separately for each specific individual application.

Disclaimer

All information contained in this document, which is based on or which refers to standards, ordinances or regulations etc., has been thoroughly researched and compiled with the greatest possible care. However, we cannot guarantee that such information is correct, complete or up to date.

Further product information

Further product information is available at www.international.geberit.com.

Copyright

All rights reserved. Texts, images, graphics etc. as well as their arrangement are subject to copyright protection.

Table of content

1	System technology	3
1.1	Introduction	3
1.2	System overview Geberit Mapress	3
1.2.1	Geberit Mapress press connection	3
1.2.2	Approvals	5
1.3	System components	6
1.3.1	Geberit Mapress system pipes	6
1.3.2	Geberit Mapress pressfittings	20
1.3.3	Geberit Mapress system seals	28
1.3.4	Geberit Mapress pressing tools	30
1.4	Laying techniques	32
1.4.1	Fitting situation	32
1.4.2	Expansion compensation	33
1.4.3	Fastening of pipes	54
1.4.4	Heat emission	55
1.4.5	Pressure loss tables	64
1.5	Operation	64
1.5.1	Geberit pressing tools	64
1.5.2	Geberit pressing jaw	64
1.5.3	Geberit Mapress pressing collar and adaptor	66
1.6	Installation	73
1.6.1	Geberit Mapress press connection	73
1.6.2	Geberit Mapress Carbon Steel, plastic coated, corrosion protection	76
1.6.3	Minimum distances and space requirements	77
1.7	Corrosion	79
1.7.1	Corrosion Geberit Mapress Stainless Steel (1.4401)	79
1.7.2	Corrosion Geberit Mapress Carbon Steel	81
1.7.3	Corrosion Geberit Mapress Copper	83
1.7.4	Corrosion Geberit MapressCuNiFe	84
1.8	Fire prevention	86
1.8.1	Classification of extinguishing water pipes	86
1.8.2	Fixed water extinguishing systems	86
1.8.3	Application range and operating conditions	87
1.8.4	Pressure test	87
1.9	Noise Insulation	88

1.10	Additional work	88
1.10.1	Pressure test	88
1.10.2	Flushing pipes	90
1.10.3	Insulation	90
1.10.4	Disinfection of Geberit piping systems	90
1.10.5	Descaling	93
1.10.6	Equipotential bonding	94
1.10.7	Operation of the pipe installations	94
2	Application technology	95
2.1	Building applications	95
2.1.1	Drinking water installation	97
2.1.2	Gas installation	103
2.1.3	Heating installations	106
2.1.4	Remote and local heat installation	109
2.1.5	Heat pump installation	109
2.1.6	Cooling water installation	111
2.1.7	Solar installations	112
2.1.8	Sprinkler systems	113
2.1.9	Oil supply installation	114
2.1.10	Special applications	114
2.2	Industrial applications	115
2.2.1	Compressed air installation	115
2.2.2	Vacuum lines	117
2.2.3	Saturated steam applications	117
2.2.4	Fuels and oils of hazard category A III	117
2.2.5	Pipelines carrying sea water	117
2.2.6	Applications Geberit MapressCuNiFe	117

1 System technology

1.1 Introduction

Geberit Mapress is one of the leading pressfitting systems worldwide and has proven its performance over the past 40 years. It offers a complete supply piping system with pressfittings, pipes, valves, tools and accessories completing the range.

With systems manufactured from Stainless Steel, Carbon Steel, Copper and CuNiFe, Geberit Mapress can be used for an extensive range of applications, from domestic drinking water and heating systems to industrial and marine uses.

1.2 System overview Geberit Mapress

Geberit Mapress comprises the pressfitting systems:

- Geberit Mapress Stainless Steel
- Geberit Mapress Carbon Steel
- Geberit Mapress Copper
- Geberit MapressCuNiFe

Geberit Mapress comprises the pipe dimensions, \varnothing 12 - 108 mm, depending on the material used.

Geberit Mapress comprises the system components:

- Geberit Mapress pressfittings
 - Geberit Mapress Stainless Steel
 - Geberit Mapress Carbon Steel
 - Geberit Mapress Copper
 - Geberit MapressCuNiFe
- Geberit Mapress valves
- Geberit Mapress pressing tools
 - ACO 102 [1]
 - ACO 202, ECO 202 [2]
 - EFP 202 [2]
 - ECO 301 [3]
 - HCPS
- Geberit Mapress accessories

1.2.1 Geberit Mapress press connection

When the system pipe is pressed together with the pressfitting, a permanent, tight-fitting connection is established which withstands longitudinal and axial forces.

Pressing

The pressfitting and system pipe are compressed in two planes:

1. **Strength:** The pipe and fitting are deformed into a hexagonal (\varnothing 12 - 35 mm) or lemon-shaped (\varnothing 42 - 108 mm) profile which provides strength and resistance to longitudinal and axial forces.
2. **Tightness:** The seal ring housing is compressed onto the pipe to provide a permanently tight joint. The profile is controlled by the design of the fitting and pressing tools to provide maximum seal-to-pipe contact area.



Figure 1: Geberit Mapress press connection before pressing



Figure 2: Geberit Mapress press connection after pressing

The Geberit Mapress CIIR black butyl rubber seal rings within the fittings incorporate patented technology which ensures that the fitting will clearly leak if it has not been pressed, yet seal perfectly after pressing. This feature allows unpressed fittings to be detected immediately, eliminating time-consuming checking for errors.

Pressing profile

The press connection is established with pressing jaws or pressing collars depending on the pipe dimension. This results in different pressing contours. The pipe dimensions $\varnothing 12 - 35 \text{ mm}$ are pressed with pressing jaws which form a hexagonal pressing contour.

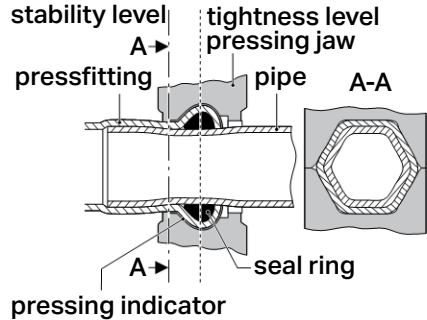

Figure 3: Cross-section of a Geberit Mapress press connection with applied pressing jaw $\varnothing 12 - 35 \text{ mm}^1$ and hexagonal pressing contour

The pipe dimensions $\varnothing 42 - 108 \text{ mm}$ are pressed with pressing collars and the corresponding adaptor jaws which form a pressing contour which is referred to as a "lemon shaped contour".

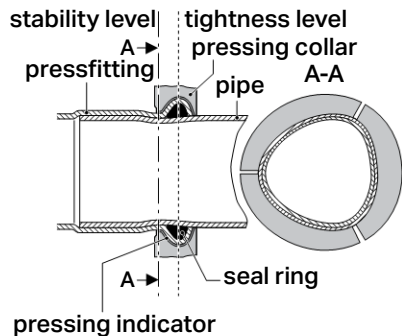

Figure 4: Cross-section of a Geberit Mapress press connection with applied pressing collar $\varnothing 35 - 108 \text{ mm}^1$ and lemon shaped contour

1 collar $\varnothing 35$ (lemon shape) for high pressure application and gas installation

1.2.2 Approvals

Table 1: Approvals for Geberit Mapress

System	Application	Testing guidelines / Codes of practice (extracts)	Approval mark ¹⁾ (extracts)
Geberit Mapress Stainless Steel ø 15 - 108 mm	<ul style="list-style-type: none"> • Drinking water • Extinguishing water • Rainwater • Treated water • Heating water • Open and closed water circuits • Compressed air • Solar systems • Heating oil EL • Oily media • Industrial gases • Saturated steam • Sprinkler (wet and dry) 	<ul style="list-style-type: none"> • DVGW W 270 • DVGW W 534 • SVGW W/TPW 132 • TRbF 231 • VdS guidelines 	<ul style="list-style-type: none"> • DW 8501AT2552 (DVGW) • SVGW 8503-1663 • ÖVGW-W 1.088 • TÜV.A.271-07 • DIBt • VdS G-4910039 • FM
Geberit Mapress Stainless Steel Gas ø 15 - 108 mm	<ul style="list-style-type: none"> • Natural gases • Liquefied gases 	<ul style="list-style-type: none"> • DVGW VP 614 • ÖVGW G1-TR Gas 	<ul style="list-style-type: none"> • DG 4550BL0118 (DVGW) • ÖVGW G 2.663
Geberit Mapress Carbon Steel ø 15 - 108 mm	<ul style="list-style-type: none"> • Closed water heating systems • Closed water circuits • Dry compressed air • Heating oil EL • Sprinkler (only wet) 	<ul style="list-style-type: none"> • DVGW W 534 • TRbF 231 • VdS 	<ul style="list-style-type: none"> • TÜV.A.271-12 • DIBt • VdS G-4070025 • FM
Geberit Mapress Copper ø 15 - 108 mm	<ul style="list-style-type: none"> • Drinking water • Heating water • Open and closed water circuits • Compressed air 	<ul style="list-style-type: none"> • DVGW W 270 • DVGW W 534 	<ul style="list-style-type: none"> • DG 4550BL0161 (DVGW)
Geberit MapressCuNiFe ø 15 - 108 mm	<ul style="list-style-type: none"> • Sea water 	<ul style="list-style-type: none"> • IACS 	please see on page 118

¹⁾ For other approvals please contact your responsible Geberit sales representative

1.3 System components

1.3.1 Geberit Mapress system pipes

System overview

Geberit Mapress system pipes are provided in the following versions:

- Geberit Mapress Stainless Steel system pipes (1.4401, 1.4521 and 1.4301)
- Geberit Mapress Carbon Steel system pipes (plastic-coated, zinc-plated on the outside, zinc-plated on the inside and outside)
- Geberit MapressCuNiFe system pipe (CuNi10Fe1.6Mn)
- Copper pipes are not available from Geberit. Product material of copper pipes in accordance with DVGW W 392 and BS EN 1057 can be used with Geberit Mapress pressfittings

All Geberit Mapress system pipes are DIN- / DVGW approved and certified system pipes.

Manufacturing standards guarantee additionally increased requirements to:

- The quality of the weld seam
- Dimensional precision
- Surface quality
- Bending capability
- Resistance to corrosion

All Geberit Mapress system pipes are checked for tightness in the factory.

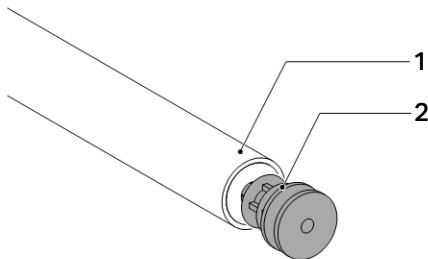

Figure 5: Geberit Mapress Stainless Steel system pipe

- 1 System pipe
- 2 Plug for hygienic sealing and for identification of the material:
blue = Stainless Steel CrNiMo steel 1.4401
green = CrMoTi steel 1.4521

Protection plug for Geberit Mapress Stainless Steel pipes

During transportation and storage, Geberit Mapress Stainless Steel pipes are protected against dirt using factory fitted plugs and packaging material. These must not be removed until they are installed to prevent contamination.

Bending Geberit Mapress System Pipes

When bending Geberit Mapress system pipes, the following rules must be observed:

- Only bend the pipes when cold and with standard bending tools
- Observe the instructions of the bending tool manufacturer for suitability of the bending tool and determination of the bending radii
- The pipes can be bent by bending tool up to $r > 3.5 \cdot d$

Geberit Mapress Stainless Steel system pipes

The delivery conditions of the external and internal surfaces of the Geberit Mapress Stainless Steel system pipes are:

- Free from annealing colours
- Metallically bright
- Free from oil / grease
- Free from corrosion-promoting / unhygienic substances

When required, paint coatings or priming coats can be applied to the Geberit Mapress Stainless Steel system pipes.

The Geberit Mapress Stainless Steel system pipes (1.4401) are also used for stainless steel gas pressfittings.

Geberit Mapress Stainless Steel system pipe CrNiMo steel (1.4401)

Material

Table 2: Material, Geberit Mapress Stainless Steel system pipe CrNiMo steel (1.4401)

Material designation	Abbreviation (DIN EN 10088-2)	Material no.	
		EN	AISI
Austenitic stainless steel	X5CrNiMo17-12-2	1.4401	316

Pipe dimensions

Table 3: Pipe dimensions, Geberit Mapress Stainless Steel system pipe CrNiMo steel (1.4401)

Nominal width	Pipe dimension	Inside diameter	Pipe weight	Water volume
DN	d x s	di	m	V
	[mm]	[mm]	[kg/m]	[l/m]
10	12 x 1.0	10	0.276	0.079
12	15 x 1.0	13	0.351	0.133
15	18 x 1.0	16	0.426	0.201
20	22 x 1.2	19.6	0.626	0.302
25	28 x 1.2	25.6	0.806	0.515
32	35 x 1.5	32	1.260	0.804
40	42 x 1.5	39	1.523	1.195
50	54 x 1.5	51	1.974	2.043
65	76.1 x 2.0	72.1	3.715	4.083
80	88.9 x 2.0	84.9	4.357	5.661
100	108 x 2.0	104	5.315	8.495

Pipes are supplied in 6 m lengths.



Geberit Mapress Stainless Steel system pipes
CrNiMo steel are pressed with Geberit
Mapress Stainless Steel pressfittings.

Physical characteristics

Table 4: Physical characteristics, Geberit Mapress Stainless Steel system pipe CrNiMo steel (1.4401)

Designation	Value	Unit
Thermal expansion coefficient α at 20 - 100 °C	0.0165	mm/(m·K)
Thermal conductivity λ at 20 °C	15	W/(m·K)
Specific thermal capacity c at 20 °C	500	J/(kg·K)
Pipe roughness k	0.0015	mm

Geberit Mapress Stainless Steel system pipes CrNiMo steel are non-combustible pipes with a longitudinal weld seam. The assignment to material classes is based on country-specific regulations.

Mechanical characteristics

Heat treatment condition: Solution annealed and quenched

Table 5: Mechanical characteristics, Geberit Mapress Stainless Steel system pipe CrNiMo steel (1.4401)

Designation	Value	Unit
Tensile strength R_m	510 - 710	N/mm ²
0.2 %-Expansion limit $R_{p0.2}$	≥ 220	N/mm ²
Breaking elongation A_5	> 40	%

Marking

Geberit Mapress Stainless Steel system pipes CrNiMo steel are marked on the surface. The following table explains the marking using a ø 54 mm pipe as an example.

Table 6: Marking, Geberit Mapress Stainless Steel system pipe CrNiMo steel (1.4401)

Marking	Explanation
■ GEBERIT Geberit Mapress	Geberit trademark
060201-II	Manufacturing date and shift (01.02.2006, afternoon shift)
S	Manufacturer's mark as agreed
325420	Melt number according to 3.1 Acceptance test certificate
54 x 1.5	Pipe dimension [mm]
1.4401 / 316	Material number EN / AISI
MPA NRW	Inspection authority
DVGW DW-8501AT2552 DVGW DG-4550BL0118 GAS	DVGW test mark with registration number
67-768 ATEC 14/02-768	CSTB and ATEC marks (approval in France)
KIWA K7304	KIWA mark (approval in the Netherlands)
ATG 2495	ATG mark (approval in Belgium)
SITAC 1422 3571/90	SITAC mark (approval in Sweden)
ÖVGW W 1.088 - 16 bar / 95 °C - TW	ÖVGW mark (approval in Austria)
W WMKA20008	SAI-Global Watermark (approval in Australia)
TÜV AR 271-02	VdTÜV component mark
◁ FM ▷	FM Approvals certification mark (USA approval, d 22 - 108 mm)

Application

- Please see table 1 on page 5

Geberit Mapress system pipe CrNi steel (1.4301)

Material

Table 7: Material, Geberit Mapress system pipe CrNi steel (1.4301)

Material designation	Abbreviation (DIN EN 10088-2)	Material no.	
		EN	AISI
Austenitic stainless steel	X5CrNi18-10	1.4301	304

Pipe dimensions

Table 8: Pipe data, Geberit Mapress system pipe CrNi steel (1.4301)

Nominal width	Pipe dimension	Internal diameter	Pipe weight	Water volume
DN	d x s	di	m	V
	[mm]	[mm]	[kg/m]	[l/m]
12	15 x 1.0	13	0.348	0.133
15	18 x 1.0	16	0.422	0.201
20	22 x 1.2	19.6	0.620	0.302
25	28 x 1.2	25.6	0.798	0.515
32	35 x 1.5	32	1.247	0.804
40	42 x 1.5	39	1.508	1.195
50	54 x 1.5	51	1.955	2.043
65	76.1 x 1.5	73.1	2.777	4.083
80	88.9 x 1.5	85.9	3.254	5.661
100	108 x 2.0	104	5.262	8.495

Pipes are supplied in 6 m lengths.



Geberit Mapress system pipes CrNi steel are pressed with Geberit Mapress Stainless Steel pressfittings.

Physical characteristics

Table 9: Physical characteristics, Geberit Mapress system pipe CrNi steel (1.4301)

Designation	Value	Unit
Thermal expansion coefficient α at 20 - 100 °C	0.016	mm/(m·K)
Thermal conductivity λ at 20 °C	15	W/(m·K)
Specific thermal capacity c at 20 °C	500	J/(kg·K)
Pipe roughness k	0.0015	mm

Geberit Mapress system pipes CrNi steel are non-combustible pipes with a longitudinal weld seam. The assignment to material classes is based on country-specific regulations.

Mechanical characteristics

Heat treatment condition: Solution annealed and quenched

Table 10: Mechanical characteristics, Geberit Mapress system pipe CrNi steel (1.4301)

Designation	Value	Unit
Tensile strength R_m	500 - 700	N/mm ²
0.2 %-Expansion limit $R_{p0.2}$	≥ 220	N/mm ²
Breaking elongation A_5	> 40	%

Marking

Geberit Mapress system pipes CrNi steel are marked on the surface. The following table explains the marking using a ø 54 mm pipe as an example.

Table 11: Marking, Geberit Mapress system pipe CrNi steel (1.4301)

Marking	Explanation
■ GEBERIT Geberit Mapress	Geberit trademark
060201-II	Manufacturing date and shift (01.02.2006, afternoon shift)
S	Manufacturer's mark as agreed
325420	Melt number according to 3.1 Acceptance test certificate
54 x 1.5	Pipe dimension [mm]
1.4301 / 304	Material number EN / AISI

Application

- Only for heating and industrial applications
- Not suitable for drinking water

Geberit Mapress system pipe CrMoTi steel (1.4521)

Material

Table 12: Material, Geberit Mapress system pipe CrMoTi steel (1.4521)

Material designation	Abbreviation (DIN EN 10088-2)	Material no.	
		EN	AISI
Ferritic stainless steel	X2CrMoTi 18-2	1.4521	444

Pipe dimensions

Table 13: Pipe data, Geberit Mapress system pipe CrMoTi steel (1.4521)

Nominal width	Pipe dimension	Internal diameter	Pipe weight	Water volume
DN	d x s	di	m	V
	[mm]	[mm]	[kg/m]	[l/m]
10	12 x 1.0	10	0.266	0.079
12	15 x 1.0	13	0.339	0.133
15	18 x 1.0	16	0.411	0.201
20	22 x 1.2	19.6	0.604	0.302
25	28 x 1.2	25.6	0.778	0.515
32	35 x 1.5	32	1.216	0.804
40	42 x 1.5	39	1.470	1.195
50	54 x 1.5	51	1.905	2.043

Pipes are supplied in 6 m lengths.



Geberit Mapress system pipes CrMoTi steel are pressed with Geberit Mapress Stainless Steel pressfittings.

Physical characteristics

Table 14: Physical characteristics, Geberit Mapress system pipe CrMoTi steel (1.4521)

Designation	Value	Unit
Thermal expansion coefficient α at 20 - 100 °C	0.0104	mm/(m·K)
Thermal conductivity λ at 20 °C	23	W/(m·K)
Specific thermal capacity c at 20 °C	430	J/(kg·K)
Pipe roughness k	0.0015	mm

Geberit Mapress system pipes CrMoTi steel are non-combustible pipes. The assignment to material classes is based on country-specific regulations.

Mechanical characteristics

Table 15: Mechanical characteristics, Geberit Mapress system pipe CrMoTi steel (1.4521)

Designation	Value	Unit
Tensile strength R_m	≥ 400	N/mm ²
0.2 %-Expansion limit $R_{p0.2}$	≥ 280	N/mm ²
Breaking elongation A_5	> 20	%

Marking

Geberit Mapress system pipes CrMoTi steel are marked on the surface with a trademark that is underlined in green. The following table explains the marking using a \varnothing 54 mm pipe as an example.

Table 16: Marking, Geberit Mapress system pipe CrMoTi steel (1.4521)

Marking	Explanation
■ GEBERIT <u>Geberit Mapress</u>	Geberit trademark
060201-II	Manufacturing date and shift (01.02.2006, afternoon shift)
S	Manufacturer's mark as agreed
325420	Melt number according to 3.1 Acceptance test certificate
54 x 1.5	Pipe dimension [mm]
1.4521 / 444	Material number EN / AISI
MPA NRW	Inspection authority
DVGW DW-8501AT2552	DVGW test mark with registration number
ÖVGW W 1.088	ÖVGW mark (approval in Austria)
SVGW 8503-1633	SVGW mark (approval in Switzerland)

Application

- Please see table 1 on page 5
- Not suitable for gas and industrial application



More force required for bending and cutting than Geberit Mapress Stainless Steel (1.4401).

Geberit Mapress Carbon Steel system pipes

Geberit Mapress Carbon Steel system pipe, outside zinc-plated

Material

Table 17: Material of Geberit Mapress Carbon Steel system pipe, outside zinc-plated

Material designation	Abbreviation (DIN EN 10305)	Material no.	
		EN	AISI
Non-alloy steel	E195 (RSt 34-2)	1.0034	1009

Table 18: Galvanizing characteristics of Geberit Mapress Carbon Steel system pipe, outside zinc-plated

Type of galvanization	Coating version (DIN 50961)	Coating thickness [μm]
Galvanically zinc-plated, blue passivated	FeZn8	8

Physical properties

Table 19: Physical characteristics of Geberit Mapress Carbon Steel system pipe, outside zinc-plated

Designation	Value	Unit
Thermal expansion coefficient α at 20 - 100 °C	0.012	mm/(m·K)
Thermal conductivity λ at 20 °C	60	W/(m·K)
Specific thermal capacity c at 20 °C	500	J/(kg·K)
Pipe roughness k	0.01	mm

Geberit Mapress Carbon Steel system pipes, outside zinc-plated, are non-combustible pipes. The assignment to material classes is based on country-specific regulations.

Mechanical properties

Table 20: Mechanical characteristics of Geberit Mapress Carbon Steel system pipe, outside zinc-plated

Designation	Value	Unit	d [mm]
Tensile strength R_m	290 - 420	N/mm ²	≤ 22
	310 - 440		≥ 28
Expansion limit R_{eH}	< 260	N/mm ²	≤ 22
	260 - 360		≥ 28
Breaking elongation A_5	> 25	%	–

Pipe data

Table 21: Technical data of Geberit Mapress Carbon Steel system pipe, outside zinc-plated

Nominal width	Pipe dimension	Internal diameter	Pipe weight	Water volume
DN	d x s	di	m	V
	[mm]	[mm]	[kg/m]	[l/m]
10	12 x 1.2	9.6	0.320	0.072
12	15 x 1.2	12.6	0.408	0.125
15	18 x 1.2	15.6	0.497	0.191
20	22 x 1.5	19	0.758	0.284
25	28 x 1.5	25	0.980	0.491
32	35 x 1.5	32	1.239	0.804
40	42 x 1.5	39	1.498	1.195
50	54 x 1.5	51	1.942	2.043
65	76.1 x 2.0	72.1	3.655	4.083
80	88.9 x 2.0	84.9	4.286	5.661
100	108 x 2.0	104	5.228	8.495

Pipes are supplied in 6 m lengths.

Marking

Geberit Mapress Carbon Steel system pipes, outside zinc-plated, are marked on the surface in red text. The following table explains the marking using a \varnothing 54 mm pipe as an example.

Table 22: Marking of Geberit Mapress Carbon Steel system pipe, outside zinc-plated

Marking in red	Explanation
■ GEBERIT Geberit Mapress	Geberit trademark
060201-II	Manufacturing date and shift (01.02.2006, afternoon shift)
S	Manufacturer's mark as agreed
325420	Melt number according to 3.1 Acceptance test certificate
54 x 1.5	Pipe dimension [mm]
1.0034 / 1009	Material number EN
◁ FM ▷	FM mark (USA approval, \varnothing 22 - 54 mm)
NPW	No Potable Water

Application

- Please see table 1 on page 5
- Not suitable for extinguishing water and sprinkler application

Geberit Mapress Carbon Steel system pipe, plastic coated

Material

Table 23: Material of Geberit Mapress Carbon Steel system pipe, plastic coated

Material designation	Abbreviation (DIN EN 10305)	Material no.	
		EN	AISI
Non-alloy steel	E195 (RSt 34-2)	1.0034	1009

Table 24: Characteristics of the plastic coating of Geberit Mapress Carbon Steel system pipe

Characteristic	Value	Unit
Material	Polypropylene	-
Density ρ	0.95 (non porous, waterproof)	g/cm ³
Thermal conductivity	0.22	W/(m·K)
Operating temp (max)	120	°C
Colour	RAL 9001 cream	-

Geberit Mapress Carbon Steel system pipes, plastic coated, can be painted using a standard primer for plastic.

Physical properties

Table 25: Physical characteristics of Geberit Mapress Carbon Steel system pipe, plastic coated

Designation	Value	Unit
Thermal expansion coefficient α at 20 - 100 °C	0.012	mm/(m·K)
Thermal conductivity λ at 20 °C	60	W/(m·K)
Specific thermal capacity c at 20 °C	500	J/(kg·K)
Pipe roughness k	0.01	mm

Geberit Mapress Carbon Steel system pipes, plastic coated, are combustible pipes. The plastic coating of these pipes burns without dripping.

Mechanical properties

Table 26: Mechanical characteristics of Geberit Mapress Carbon Steel system pipe, plastic coated

Designation	Value	Unit	d [mm]
Tensile strength R_m	290 - 420	N/mm ²	≤ 22
	310 - 440		≥ 28
Upper elastic limit R_{eH}	< 260	N/mm ²	≤ 22
	260 - 360		≥ 28
Breaking elongation A_5	> 25	%	-

Pipe data

Table 27: Technical data of Geberit Mapress Carbon Steel system pipe, plastic coated



Nominal width	Pipe dimension	Outside diameter (with plastic jacket)	Inside diameter	Pipe weight	Water volume
DN	d x s	di	di	m	V
	[mm]	[mm]	[mm]	[kg/m]	[l/m]
10	12 x 1.2	14	9.6	0.338	0.072
12	15 x 1.2	17	12.6	0.434	0.125
15	18 x 1.2	20	15.6	0.536	0.191
20	22 x 1.5	24	19	0.824	0.284
25	28 x 1.5	30	25	1.052	0.491
32	35 x 1.5	37	32	1.320	0.804
40	42 x 1.5	44	39	1.620	1.195
50	54 x 1.5	56	51	2.098	2.043

Pipes are supplied in 6 m lengths.

Marking

Geberit Mapress Carbon Steel system pipes, plastic coated, are marked on the surface.

Table 28: Marking of Geberit Mapress Carbon Steel system pipe, inside and outside zinc-plated

Marking	Explanation
	Logo Geberit Mapress
Red pressing indicator	The pressing indicator indicates unpressed connections. The colour „red“ indicates the product material „carbon steel“. The indicator is removed once the fitting is pressed.
28	Outside diameter (mm)
	FM mark (USA approval, \varnothing 22 - 54 mm)
VdS	VdS approval \varnothing 28 - 54 mm
BF	Production code

Geberit Mapress Carbon Steel pressfittings also come with a clear protection plug which protects the fitting from dirt and dust.

Application

- For visible heating installation

Geberit Mapress Carbon Steel system pipes, inside and outside zinc-plated for sprinkler application

Geberit Mapress Carbon Steel pipe, inside and outside zinc-plated, cannot be used for potable water or heating installations. It must only be used for sprinkler or compressed air applications. If using in a sprinkler system, it must be for wet sprinklers, not dry. If a dry sprinkler system is required, Geberit Mapress Stainless Steel must be used. If in doubt please contact Geberit for technical support.

Material

Table 29: Material of Geberit Mapress Carbon Steel system pipe, inside and outside zinc-plated

Material designation	Abbreviation (DIN EN 10305)	Material no.	
		EN	AISI
Non-alloy steel	E220	1.0215	1009

Table 30: Galvanizing characteristics of Geberit Mapress Carbon Steel system pipe, inside and outside zinc-plated

Type of galvanization	Coating version (DIN EN 10326)	Coating thickness [μm]
Hot-dip coating	Z275	20

Physical properties

Table 31: Physical characteristics of Geberit Mapress Carbon Steel system pipe, inside and outside zinc-plated

Designation	Value	Unit
Thermal expansion coefficient α at 20 - 100 °C	0.012	mm/(m·K)
Thermal conductivity λ at 20 °C	60	W/(m·K)
Specific thermal capacity c at 20 °C	500	J/(kg·K)
Pipe roughness k	0.01	mm

Geberit Mapress Carbon Steel system pipes, inside and outside zinc-plated, are non-combustible pipes. The assignment to material classes is based on country-specific regulations.

Mechanical properties

Heat treatment condition: Unannealed

Table 32: Mechanical characteristics of Geberit Mapress Carbon Steel system pipe, inside and outside zinc-plated

Designation	Value	Unit
Tensile strength R_m	> 310	N/mm ²
Breaking elongation A_5	> 25	%

Pipe data

Table 33: Technical data of Geberit Mapress Carbon Steel system pipe, inside and outside zinc-plated

Nominal width	Pipe dimension	Internal diameter	Pipe weight	Water volume
DN	d x s	di	m	V
	[mm]	[mm]	[kg/m]	[l/m]
20	22 x 1.5	19	0.758	0.284
25	28 x 1.5	25	0.980	0.491
32	35 x 1.5	32	1.239	0.804
40	42 x 1.5	39	1.498	1.195
50	54 x 1.5	51	1.942	2.043
65	76.1 x 2.0	72.1	3.655	4.083
80	88.9 x 2.0	84.9	4.286	5.661
100	108 x 2.0	104	5.228	8.495

Pipes are supplied in 6m lengths.

Marking

Geberit Mapress Carbon Steel system pipes, inside and outside zinc-plated, are marked on the surface in black text. The following table explains the marks using a \varnothing 54 mm pipe as an example.

Table 34: Marking of Geberit Mapress Carbon Steel system pipe, inside and outside zinc-plated

Marking	Explanation
■ GEBERIT Geberit Mapress	Geberit trademark
060201-II	Manufacturing date and shift (01.02.2006, afternoon shift)
S	Manufacturer's mark as agreed
325420	Melt number according to 3.1 Acceptance test certificate
54 x 1.5	Pipe dimension [mm]
1.0215	Material number EN
◁ FM ▷	FM mark (USA approval, \varnothing 22 - 54 mm)
VdS G 4030020	VdS approval \varnothing 22 - 54 mm (sprinkler)
VdS G 4070025	VdS approval \varnothing 76.1 - 108 mm (sprinkler)

Application

- Sprinkler (only wet)
- Compressed air
- Not suitable for drinking water and heating installations

Geberit MapressCuNiFe system pipes

Product material

Table 35: Product material Geberit MapressCuNiFe system pipes

Material designation	Abbreviation	Material no.
Copper-nickel forging alloy	CuNi10Fe1.6Mn	2.1972.11 (according to product material performance sheet WL 2.1972)

Physical properties

Table 36: Physical properties Geberit MapressCuNiFe system pipe

Designation	Value	Unit
Thermal expansion coefficient α at 20 - 100 °C	0.017	mm/(m·K)
Thermal conductance λ at 20 °C	50	W/(m·K)
Specific thermal capacity c at 20 °C	377	J/(kg·K)

Geberit MapressCuNiFe system pipes are non-combustible pipes. The assignment to material classes is based on country-specific regulations.

Mechanical properties

Table 37: Mechanical properties Geberit MapressCuNiFe system pipe according to DIN 86019, strength F 30 (soft)

Designation	Value	Unit
Tensile strength R_m	300 - 400	N/mm ² (MPa)
0.2 %-Expansion limit $R_{p0.2}$	100 - 180	N/mm ² (MPa)
Breaking elongation A_5	≥ 30	%

Pipe data

Table 38: Pipe data Geberit MapressCuNiFe system pipe (according to DIN 86019)

Nominal width	Pipe dimension	Internal diameter	Pipe weight	Water volume	Recommended bending radius
DN	d x s [mm]	di [mm]	m [kg/m]	V [l/m]	r [mm]
12	15 x 1.0	13	0.390	0.133	≥ 3.5·d
20	22 x 1.0	20	0.590	0.314	
20	22 x 1.5	19	0.860	0.284	
25	28 x 1.5	25	1.110	0.491	
32	35 x 1.5	32	1.410	0.804	
40	42 x 1.5	39	1.700	1.195	
50	54 x 1.5	51	2.210	2.043	
65	76.1 x 2.0	72.1	4.140	4.083	–
80	88.9 x 2.0	84.9	4.870	5.661	–
100	108 x 2.5	103	7.380	8.332	–

Pipes are supplied in 5 - 6 m lengths.

Marking

Geberit MapressCuNiFe system pipes are marked on the surface. The following table explains the marks using a \varnothing 54 mm pipe as an example.

Table 39: Marking Geberit MapressCuNiFe system pipe

Marking	Explanation
 GEBERIT Geberit Mapress	Geberit trademark
060201-II	Manufacturing date and shift (01.02.2006, afternoon shift)
Eucaro 10	Manufacturer's mark as agreed
325420	Melt number according to 3.1 Acceptance test certificate
54 x 1.5	Pipe dimension [mm]
CuNi10Fe1.6Mn	Abbreviation

Application

- Salt water application (shipbuilding)
- Please see table 92 on page 117

1.3.2 Geberit Mapress pressfittings

System overview

The basic element for the press connection is that of a plastic moulding designed pressfitting. Geberit Mapress pressfittings are provided in the following versions:

- Geberit Mapress Stainless Steel
- Geberit Mapress Stainless Steel Solar and Industry
- Geberit Mapress Stainless Steel Gas
- Geberit Mapress Stainless Steel Silicone Free
- Geberit Mapress Carbon Steel
- Geberit Mapress Carbon Steel Solar and Industry
- Geberit Mapress Copper
- Geberit Mapress Copper Solar and Industry
- Geberit MapressCuNiFe
- Geberit MapressCuNiFe Industry

Transport and storage

The pressfittings are appropriately packed in plastic bags in the factory.

Geberit Mapress pressfittings also come with a protection plug which protects the fitting from dirt and dust.

Substances that constrain from painting

All system pipes and pressfittings without pressing socket (e. g. bend with plain ends) as well as all pressfittings made of non-alloy steel are always supplied free of substances that constrain from painting (LABS-free).

To prevent contamination, Geberit Mapress Stainless Steel LABS-free fittings are individually bagged to guarantee they are silicone-free. LABS-free components must be ordered separately.

Pressing indicator

The fitting beads are provided with a pressing indicator at the factory. The pressing indicator has the following functions:

- Indicates to the plumber before the pressure test that there are unpressed connections
- Displays the dimensions of the fitting in unpressed status
- Colour indicates the type of product material concerned
- Clearly identifies the fitting as a Geberit product

The pressing indicator is destroyed by the pressing procedure and is subsequently manually removed by the plumber.

Table 40: Product material of Geberit Mapress pressing indicator

Material designation	Abbreviation	Recycling code
Multi-layer film	PET-PS-PET	

Protection plug

Geberit Mapress pressfittings are closed with a Geberit Mapress protection plug for transport and storage.

The protection plug has the following functions:

- Protects the seal ring as well as the insert section from dirt and dust
- Indicates the diameter of the pressfitting
- Colour indicates the seal ring used and the application range
 - Transparent: Standard application with black CIIR seal ring (delivery condition in standard range)
 - Anthracite grey: Special application with seal ring FKM blue
 - Yellow: Gas application with seal ring HNBR yellow

The protection plug can be reused or recycled.

Table 41: Product material of Geberit Mapress protection plug

Material designation	Abbreviation	Recycling code
Polyethylene low density	PE-LD	

Geberit Mapress Stainless Steel pressfitting

Material



Table 42: Product material of Geberit Mapress Stainless Steel pressfitting

Material designation	Abbreviation (DIN EN 10088-2)	Material no.	
		EN	AISI
Austenitic stainless steel	X5CrNiMo17-12-2	1.4401	316

Marking

Geberit Mapress Stainless Steel pressfittings are marked on the surface. The following table explains the marks using a \varnothing 28 mm fitting as an example.

Table 43: Marking of Geberit Mapress Stainless Steel pressfitting

Marking	Explanation
	Logo Geberit Mapress
Blue pressing indicator	The pressing indicator indicates unpressed connections. The colour „blue“ indicates the product material „stainless steel“. The indicator is removed once the fitting is pressed.
DVGW	DVGW approval
28	Outside diameter [mm]
	FM mark (approval USA, \varnothing 22 - 108 mm)
VdS	VdS approval \varnothing 22 - 108 mm
BF	Production code

Geberit Mapress Stainless Steel pressfittings also come with a clear protection plug which protects the fitting from dirt and dust.

Geberit Mapress Stainless Steel LABS-free pressfitting

Material



Table 44: Product material Geberit Mapress Stainless Steel LABS-free pressfitting

Material designation	Abbreviation (DIN EN 10088-2)	Material no.	
		EN	AISI
Austenitic stainless steel	X5CrNiMo17-12-2	1.4401	316

Marking

Geberit Mapress Stainless Steel LABS-free pressfittings are marked on the surface. The following table explains the marks using a \varnothing 28 mm fitting as an example.

Table 45: Marking of Geberit Mapress Stainless Steel LABS-free pressfitting

Marking	Explanation
	Logo Geberit Mapress
Blue pressing indicator	The pressing indicator indicates unpressed connections. The colour „blue“ indicates the product material „stainless steel“. The indicator is removed once the fitting is pressed.
DVGW	DVGW approval
28	Outside diameter [mm]
	FM mark (approval USA, \varnothing 22 - 108 mm)
VdS	VdS approval \varnothing 22 - 108 mm
BF	Production code

Geberit Mapress Stainless Steel LABS-free pressfittings are packed individually which protects the fitting from dirt and dust.

Geberit Mapress Stainless Steel Gas pressfitting

Material

Table 46: Product material Geberit Mapress Stainless Steel Gas pressfitting

Material designation	Abbreviation (DIN EN 10088-2)	Material no.	
		EN	AISI
Austenitic stainless steel	X5CrNiMo17-12-2	1.4401	316

Marking

Geberit Mapress Stainless Steel Gas pressfittings are marked on the surface. The following table explains the marks using a \varnothing 28 mm fitting as an example.

Table 47: Marking of Geberit Mapress Stainless Steel Gas pressfitting

Marking	Explanation
	Logo Geberit Mapress
Yellow colour marking	Only for gas installations
Blue pressing indicator	The pressing indicator indicates unpressed connections. The colour „blue“ indicates the product material „stainless steel“. The indicator is removed once the fitting is pressed.
DVGW	DVGW approval
28	Outside diameter [mm]
GT / 5	HTB approval up to 5 bar
PN 5	Maximum operating pressure 5 bar
BF	Production code

Geberit Mapress Stainless Steel Gas pressfittings also come with a yellow protection plug to clearly show it can be used in gas installations. This also protects the fitting from dirt and dust.

Geberit Mapress Carbon Steel pressfitting

Material

Table 48: Product material of Geberit Mapress Carbon Steel pressfitting

Material designation	Abbreviation (DIN EN 10305)	Material no.	
		EN	AISI
Non-alloy steel	E195 (RSt 34-2)	1.0034	1009



Table 49: Galvanizing characteristics of the Geberit Mapress Carbon Steel pressfitting

Type of galvanization	Coating version (DIN 50961)	Coating thickness [µm]
Galvanically zinc-plated, blue passivated	FeZn8	8

Marking

Geberit Mapress Carbon Steel pressfittings are marked on the surface. The following table explains the marks using a \varnothing 28 mm fitting as an example.

Table 50: Marking of Geberit Mapress Carbon Steel pressfitting

Marking	Explanation
	Logo Geberit Mapress
Red pressing indicator	The pressing indicator indicates unpressed connections. The colour „red“ indicates the product material „carbon steel“. The indicator is removed once the fitting is pressed.
28	Outside diameter [mm]
	FM mark (USA approval, \varnothing 22 - 54 mm)
VdS	VdS approval \varnothing 28 - 54 mm
BF	Production code

Geberit Mapress Carbon Steel pressfittings also come with a clear protection plug which protects the fitting from dirt and dust.

Geberit Mapress Copper pressfitting

Material

Table 51: Product material of Geberit Mapress Copper pressfitting

Material designation	Abbreviation (DIN EN 1057)	Material no.	
		EN	UNS
Copper	Cu-DHP	CW024A	C12200
Gunmetal	CuSn5Zn5Pb2-c	CC491K	Not standardized
DR Brass	CuZn36PB2As	CW602N	C35330
Brass	CuZn40Pb2	CW617N	C38000

Marking

Geberit Mapress Copper pressfittings are marked on the surface. The following table explains the marks using a \varnothing 28 mm fitting as an example.

Table 52: Marking of Geberit Mapress Copper pressfitting

Marking	Explanation
	Logo Geberit Mapress
White pressing indicator	The pressing indicator indicates unpressed connections. The colour „white“ indicates the product materials „copper“, „gunmetal“ and „brass“. The indicator is removed once the fitting is pressed.
28	Outside diameter [mm]
DVGW	DVGW approval
BF	Production code

Geberit Mapress Copper pressfittings also come with a clear protection plug which protects the fitting from dirt and dust.

Geberit Mapress CuNiFe pressfitting

Material

Table 53: Product material MapressCuNiFe pressfitting

Material designation	Abbreviation	Material no.
Copper-nickel forging alloy	CuNi10Fe1.6Mn	2.1972.11 (according to product material performance sheet WL 2.1972)

Marking

MapressCuNiFe pressfittings are marked on the surface. The following table explains the markings using a \varnothing 28 mm fitting as an example.

Table 54: Marking of MapressCuNiFe pressfitting

Marking	Explanation
	Geberit Mapress logo
Black pressing indicator	The pressing indicator indicates unpressed connections The colour "black" indicates the product material "CuNiFe"
28	Outside diameter [mm]
BF	Production code

Geberit MapressCuNiFe pressfittings also come with a clear protection plug which protects the fitting from dirt and dust.

1.3.3 Geberit Mapress system seals

Operating conditions

Table 55: Technical data and applications of the Geberit Mapress seal rings

	Seal ring CIIR black	Seal ring HNBR yellow	Seal ring FKM blue	Seal ring FKM white	Seal ring FKM red
Technical abbreviation	CIIR	HNBR	FKM	FKM	FKM
Material	Butyl rubber	Hydrogenated acrylonitrile-butadiene rubber	Fluorocarbon rubber	Fluorocarbon rubber	Fluorocarbon rubber
Colour	black	yellow	blue	white	red
Minimum operating temperature	-30 °C	-20 °C	-25 °C (solar) -20 °C (industry)	5 °C	-10 °C
Maximum operating temperature	120 °C	70 °C	180 °C (solar) ¹⁾ 180 °C (industry) ²⁾	155 °C (short time 170 °C)	180 °C
Maximum operating pressure	16 bar ³⁾	5 bar	16 bar ³⁾	6 bar	16 bar ³⁾
Tests	<ul style="list-style-type: none"> • KTW recommendation • VdS Approval for wet systems • VdTUV Approval 	<ul style="list-style-type: none"> • HTB test for high thermal loads 	<ul style="list-style-type: none"> • VdTÜV Approval • DIBt • SPF (Institut for solar technic) 	–	<ul style="list-style-type: none"> • VdS Approval for dry sprinkler systems
Geberit Mapress system	<ul style="list-style-type: none"> • Geberit Mapress Stainless Steel • Geberit Mapress Carbon Steel • Geberit Mapress Copper⁴⁾ • Geberit Mapress-CuNiFe 	<ul style="list-style-type: none"> • Geberit Mapress Stainless Steel Gas • Geberit Mapress Copper Gas (≤ ø 54 mm) 	<ul style="list-style-type: none"> • Geberit Mapress Stainless Steel Solar and Industry • Geberit Mapress Carbon Steel Solar and Industry • Geberit Mapress Copper Solar and Industry (≤ ø 54 mm) 	<ul style="list-style-type: none"> • Geberit Mapress Stainless Steel • Geberit Mapress Copper 	<ul style="list-style-type: none"> • Geberit Mapress Stainless Steel (is used by fitters for dry sprinkler application)
Application	<ul style="list-style-type: none"> • Drinking water application • Extinguishing water pipes • Rainwater • Treated water • Water heating systems • Water circuits • Oil-free compressed air • Inert gases (non-toxic / non-explosive) 	<ul style="list-style-type: none"> • Gas installation with natural gases (NG) and liquefied gases (LPG) 	<ul style="list-style-type: none"> • Solar Systems • Oil-free and oiled compressed air • Technical liquides • Fuels • Mineral oil • Heating oil EL • Stationary water extinguishing systems (wet systems) 	<ul style="list-style-type: none"> • Saturated Steam - contact us for details 	<ul style="list-style-type: none"> • Stationary water extinguishing systems (dry systems)

(Sheet 1 of 2)

	Seal ring CIIR black	Seal ring HNBR yellow	Seal ring FKM blue	Seal ring FKM white	Seal ring FKM red
Other media or applications	Upon request	–	Upon request	Upon request	Upon request

(Sheet 2 of 2)

- 1) At a standstill: 180 °C for 200 h/year; 200 °C for 60 h/year or 220 °C for 500 h/total (life cycle)
- 2) After approval by Geberit
- 3) Higher pressure possible upon consultation with Geberit
- 4) Geberit Mapress Copper ø 66.7 - 108 mm uses EPDM black seal ring

Table 56: Technical data and applications, Geberit Mapress EPDM and Geberit Mapress FKM flat gasket

	Geberit Mapress EPDM flat gasket	Geberit Mapress FKM flat gasket
Technical abbreviation	EPDM	FKM
Material	Ethylene propylene diene polymer rubber	Fluorocarbon rubber
Colour	Black	Blue
Minimum operating temperature	0 °C	-10 °C
Maximum operating temperature	100 °C	Depending on application range
Application	<ul style="list-style-type: none"> • Drinking water installations • Extinguishing water pipes • Rainwater • Treated water • Water heating systems • Water circuits • Oil-free compressed air • Inert gases (non-toxic /non-explosive) 	<ul style="list-style-type: none"> • Solar systems • Mineral oil • Heating oil • Oil-free and oil-bearing compressed air • Other application ranges on request

1.3.4 Geberit Mapress pressing tools

System overview

Geberit Mapress pressfitting systems are provided in the following versions:

- ACO 102
- EFP 202, ECO 202, ACO 202
- ECO 301
- HCPS

General information

Geberit Mapress pressfitting systems are pressed using the corresponding Geberit Mapress pressing tool. In doing so, no difference can be distinguished between Geberit Mapress Stainless Steel, Mapress Carbon Steel, Mapress Copper and MapressCuNiFe. The pressing contour of the pressing jaws and pressing collars has been adapted precisely to the fitting's bead and geometry.

Maintenance

The pressing tool must be checked and maintained on a regular basis in the scope of the warranty and functional safety of the pressed joint. This is described in detail in the operating instructions for the pressing tool.













Service

The pressing contours of the pressing jaw / pressing collar must be free of dirt and deposits.

The respective operating instructions for the pressing tool must be observed.

Pressing tools

Geberit Mapress pressing tools can be used as follows:

Compatibility class	Pressing devices	Pressing jaws / pressing collars	Adapters for pressing collars
1	ACO 102	 ø 12–28 mm	–
2	EFP 202, ECO 202, ACO 202	 ø 12–35 mm	–
2	EFP 202, ECO 202, ACO 202	 ø 42–54 mm	 ZB 203
3	ECO 301	 ø 12–35 mm	–
3	ECO 301	 ø 42–54 mm	 ZB 303
3	ECO 301	 ø 76.1–88.9 mm	 ZB 321
3	ECO 301	 ø 108 mm	 ZB 321 + ZB 322
–	HCPS	 ø 76.1–108 mm	–

Pressing jaws ø 42–54 mm are not permitted for gas applications.

Only use pressing devices which have been approved by Geberit .

1.4 Laying techniques

1.4.1 Fitting situation

Creation of expansion space

There are different types of pipe laying:

- On the wall
- In installation ducts
- Concealed
- Under cast plaster floors

There is room for expansion on the wall or in installation ducts. When pipes are concealed it must be ensured that they are surrounded by an elastic padding layer of fibre insulation material, such as glass wool or rock wool, or in closed-cell foam. This also meets acoustic insulation requirements.

Pipes installed under cast plaster floors are fitted in the impact insulation layer and can expand freely. The vertical pipe exits from the floor should be paid particular attention: Branches in the area of the plaster cast floor must be fitted with an elastic sleeve. The same applies for pipe openings in walls and ceilings, where padding ensures freedom of movement in all directions.

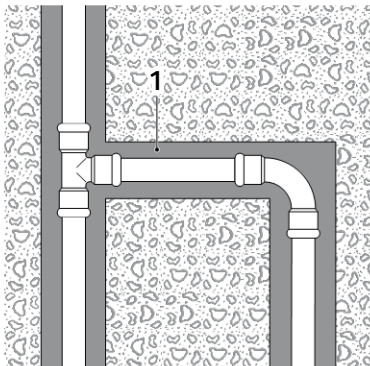

Figure 6: Concealed pipe

- 1 Elastic padding

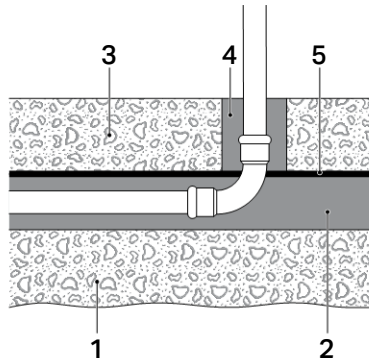

Figure 7: Pipe under cast plaster floor

- 1 Solid ceiling
- 2 Insulation layer
- 3 Cast plaster floor
- 4 Elastic sleeve
- 5 Cover

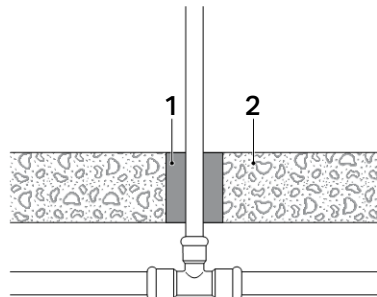

Figure 8: Pipe under ceiling openings

- 1 Elastic padding
- 2 Ceiling

Installation under cast plaster floor

Installation of Geberit pressfitting systems on an uncovered concrete ceiling inside the insulation layer of a cast plaster floor is possible without any noteworthy negative influence on the insulating properties of the cast plaster floor.

The impact noise protection of the ceiling with such a pipe installed in a cast plaster floor is sufficient for the higher noise insulation requirements in residential buildings.

Extract from DIN 18560, Cast plaster floors in building applications: **"Pipes which are installed on supporting underlying surfaces must be specified. Compensation measures are necessary to create a flat surface for accommodating the insulation layer or at least an impact noise insulation layer. The necessary construction height must be included in plans. Loose layers of natural or crushed sand may not be used for compensation."**

Installation under cast asphalt floors

When installing Geberit Mapress Carbon Steel under cast asphalt, the thermal effects of the asphalt layer can negatively influence the strength and cause excessive stress on the seal ring. Geberit Mapress Carbon Steel can be cast in asphalt if the following protection is provided:

- Inner cooling of the pipes with running water
- Covering of all pipes with bitumen, corrugated cardboard or similar, whereby the pipes are often installed in loose insulation layers

1.4.2 Expansion compensation

Expansion compensation in general

Pipes expand differently due to thermal effects depending on the material.

Therefore, the following should be considered when installing:

- Creation of expansion space
- Installation of expansion compensations
- Positioning of anchor points and sliding points

The bending and torsional stress occurring during the operation of a pipe are reliably absorbed when the expansion compensation is taken into account.

The following affect the expansion compensation:

- Product material
- Building conditions
- Operating conditions

Slight changes in the length of pipes can be absorbed through the elasticity of the piping system or through insulation.

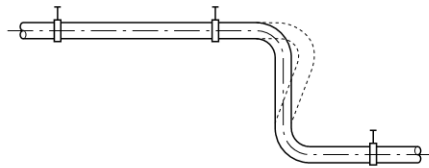

Figure 9: Absorption of change in length by through the elasticity of the piping system

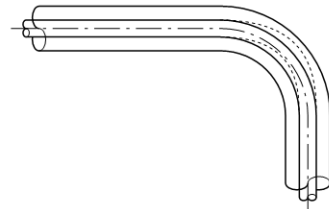

Figure 10: Absorption of a change in length through insulation

The following rule of thumb applies for the determination of the insulation thickness:

Insulation thickness = 1.5 · change in length

If the calculated insulation thickness is less than the minimum insulation thickness defined in the regulations, the minimum insulation thickness defined in the regulations must be used.

Expansion compensators used are:

- Pipe leg
- U bend
- Compensators

The following figures show the principle assembly of the pipe leg and U bend.

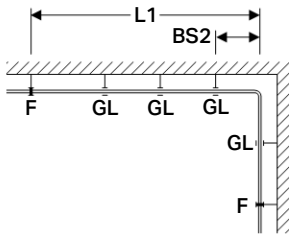

Figure 11: Expansion compensation by pipe leg

BS Bending leg
F Anchor point
GL Sliding point
L Pipe length

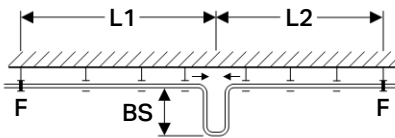

Figure 12: Expansion compensation by U bends

BS Bending leg
F Anchor point
L Pipe length

The following figures show commercially available compensators that can be used for absorbing the pipe expansions:

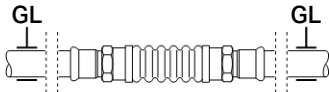

Figure 13: Commercially available axial compensator with female thread and Geberit Mapress adapter with male thread

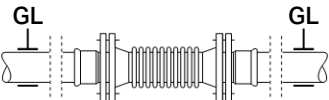

Figure 14: Commercially available axial compensator with flange connection

On riser pipes which run through several floors and therefore have more anchor points, the change in length between the individual anchor points must be absorbed by bending legs or axial expansion fittings.

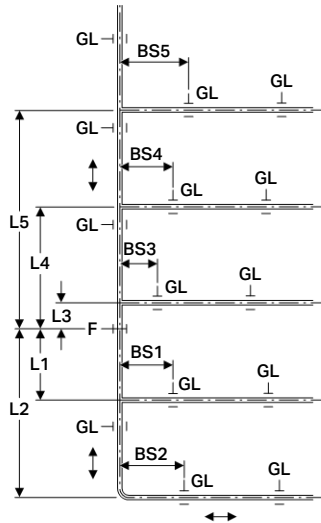

Figure 15: Expansion compensation by bending leg with anchor point in middle floor

BS Bending leg
F Anchor point
GL Sliding point
L Pipe length

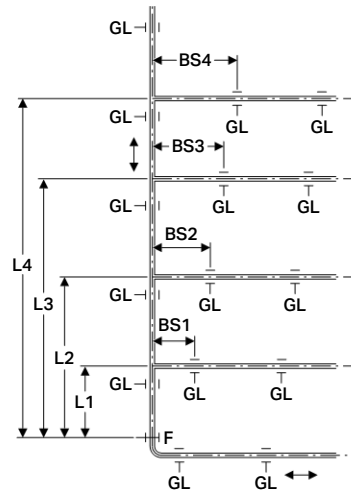

Figure 16: Expansion compensation by bending leg with anchor point in bottom floor

BS Bending leg
F Anchor point
GL Sliding point
L Pipe length

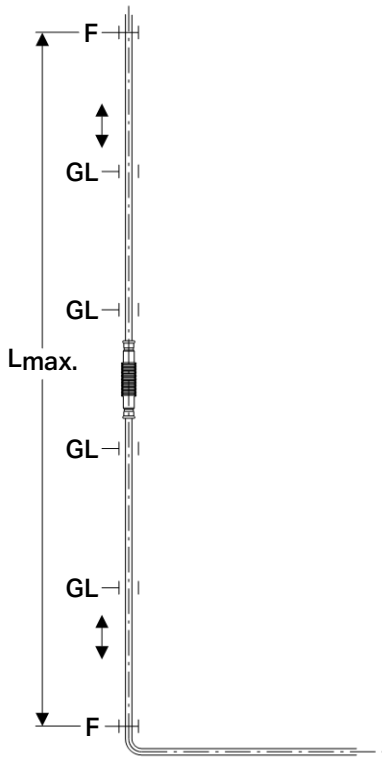

Figure 17: Expansion compensation by axial expansion fitting in riser pipe

F Anchor point
 GL Sliding point
 L_{max} Pipe length

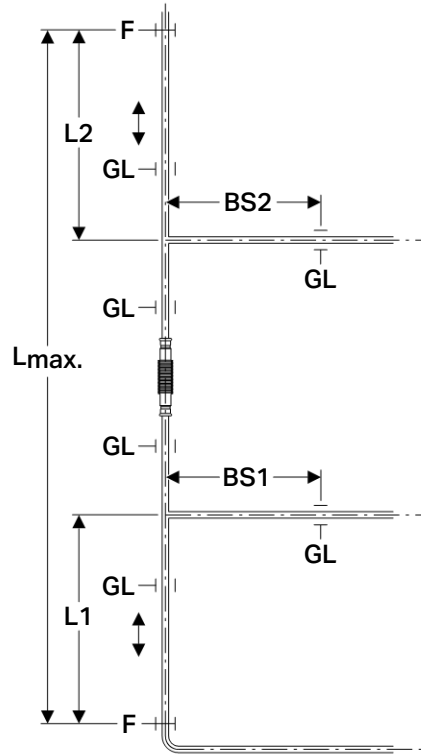

Figure 18: Expansion compensation by axial expansion fitting with anchor point in bottom floor

BS Bending leg
 F Anchor point
 GL Sliding point
 L_{max} Pipe length

Intended use of axial expansion fittings

Geberit Mapress axial expansion fittings may only be used for the compensation of axial expansions in straight pipe sections.

Installation of axial expansion fittings

- Do not stress the axial expansion fitting by twisting
- Do not use swing suspensions between anchor points
- Firmly mount fixed and sliding points before conducting a pressure test
- The sliding points must be designed as pipe guides
- Only one axial expansion fitting may be mounted between two anchor points

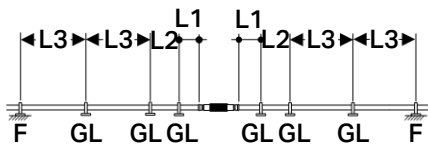

Figure 19: Installation of axial expansion fittings

GL Sliding point
F Anchor point

Table 57: Bracket spacing for axial expansion fittings (see figure 19)

∅	L1	L2 max.	L3 max.
[mm]	[cm]	[cm]	[cm]
15	3.0	95	135
18	3.5	105	155
22	5.5	120	175
28	6.0	140	200
35	7.0	155	225
42	9.0	175	250
54	11.0	195	280
76.1	15.0	225	320
88.9	18.0	250	355
108	22.0	280	400

Expansion compensation through the bending leg Geberit Mapress Stainless Steel

The expansion of pipes depends on the product material, among other things. Material-dependent parameters must be considered when calculating the deflection leg length.

The following table lists the parameters for Geberit Mapress Stainless Steel.

Table 58: Material-dependent parameters for calculating the deflection leg length of Geberit Mapress Stainless Steel

Product material of pipe	System pipe	Thermal expansion coefficient α [mm/(m·K)]	Material constant	
			C	U
CrNiMo steel, material number 1.4401	Geberit Mapress Stainless Steel	0.0165	60	34
CrNi steel, material number 1.4301	Geberit Mapress CrNi Steel	0.0160	58	33
CrMoTi steel, material number 1.4521	Geberit Mapress CrMoTi Steel	0.0104	42	24

The calculation of the deflection leg length comprises the following steps:

- Calculation of the change in length Δl
- Calculation of the deflection leg length

The following section shows example values for calculating the bending leg length L_B and L_U for Geberit Mapress Stainless Steel.

Calculation of the change in length Δl

The change in length is calculated using the following formula:

$$\Delta l = L \cdot \alpha \cdot \Delta T$$

Δl : Change in length [m]

L : Pipe length [m]

ΔT : Temperature differential (operating temperature - ambient temperature at time of installation) [K]

α : Thermal expansion coefficient [mm/(m·K)]

Given:

- Product material: CrNiMo steel, material number 1.4401
- $\alpha = 0.0165$ mm/(m·K)
- $L = 35$ m
- $\Delta T = 50$ K

Required:

- Change in length Δl of the pipe [mm]

Solution:

$$\Delta l = L \cdot \alpha \cdot \Delta T \left[\frac{\text{m} \cdot \text{mm} \cdot \text{K}}{\text{m} \cdot \text{K}} = \text{mm} \right]$$

$$\Delta l = 35 \text{ m} \cdot 0.0165 \frac{\text{mm}}{\text{m} \cdot \text{K}} \cdot 50 \text{ K}$$

$$\Delta l = 29 \text{ mm}$$

Table 59: Change in length Δl for Geberit Mapress Stainless Steel system pipe

Pipe length L [m]	Temperature differential ΔT [K]									
	10	20	30	40	50	60	70	80	90	100
	Change in length Δl [mm]									
1	0.17	0.33	0.50	0.66	0.83	0.99	1.16	1.32	1.49	1.65
2	0.33	0.66	0.99	1.32	1.65	1.98	2.31	2.64	2.97	3.30
3	0.50	0.99	1.49	1.98	2.48	2.97	3.47	3.96	4.46	4.95
4	0.66	1.32	1.98	2.64	3.30	3.96	4.62	5.28	5.94	6.60
5	0.83	1.65	2.48	3.30	4.13	4.95	5.78	6.60	7.43	8.25
6	0.99	1.98	2.97	3.96	4.95	5.94	6.93	7.92	8.91	9.90
7	1.16	2.31	3.47	4.62	5.78	6.93	8.09	9.24	10.40	11.55
8	1.32	2.64	3.96	5.28	6.60	7.92	9.24	10.56	11.88	13.20
9	1.49	2.97	4.46	5.94	7.43	8.91	10.40	11.88	13.37	14.85
10	1.65	3.30	4.95	6.60	8.25	9.90	11.55	13.20	14.85	16.50

Calculation of the deflection leg length

The calculation of the deflection leg length depends on the type of deflection leg:

- Expansion compensation through pipe leg / for branch pipes: Calculation of the bending leg length L_B
- Expansion compensation by U-bend: Calculation of the deflection leg length L_U

Calculation of the deflection leg length L_B

The deflection leg length L_B to be calculated is defined as follows with expansion compensation by pipe legs and for branch pipes:

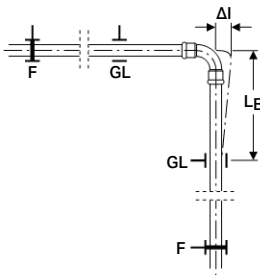

Figure 20: Expansion compensation by pipe leg

- F Anchor point
- GL Sliding point
- L_B Deflection leg length

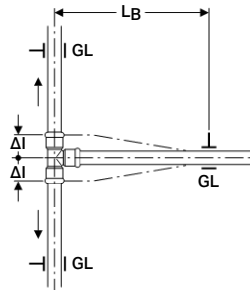

Figure 21: Expansion compensation for branch pipe

- F Anchor point
- GL Sliding point
- L_B Deflection leg length

The deflection leg length L_B is calculated using the following formula:

$$L_B = \frac{C \cdot \sqrt{d \cdot \Delta l}}{1000}$$

- L_B Deflection leg length [m]
- d Pipe outside diameter [mm]
- Δl Change in length [mm]
- C Material constant (see table 58 on page 37)

Given:

- Product material: CrNiMo steel, material number 1.4401
- $C = 60$
- $d = 54 \text{ mm}$
- $\Delta l = 29 \text{ mm}$

Required:

- $L_B \text{ [m]}$

Solution:

$$L_B = \frac{C \cdot \sqrt{d \cdot \Delta l}}{1000} \left[\frac{\sqrt{\text{mm} \cdot \text{mm}}}{\frac{\text{mm}}{\text{m}}} = \text{m} \right]$$

$$L_B = \frac{60 \cdot \sqrt{54 \cdot 29}}{1000} \text{ m}$$

$$L_B = 2.37 \text{ m}$$

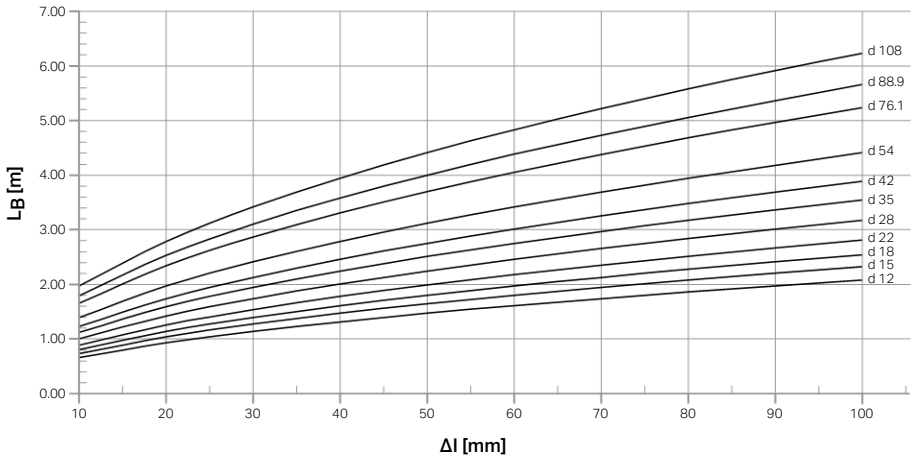

Figure 22: Calculation of the deflection leg length L_B for Geberit Mappress Stainless Steel 1.4401

Calculation of the deflection leg length L_U

The deflection leg length L_U to be calculated is defined as follows:

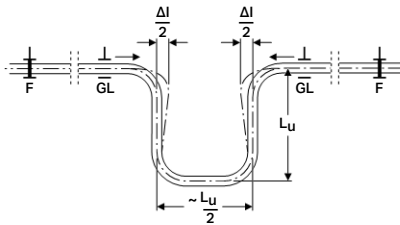

Figure 23: U-bend expansion compensation from bent pipe

F Anchor point
GL Sliding point
 L_U Deflection leg length

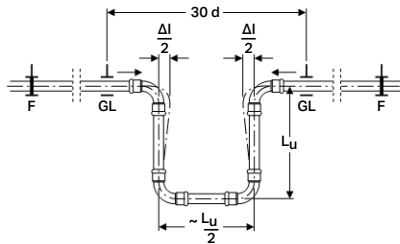

Figure 24: U-bend expansion compensation with pressfittings

F Anchor point
GL Sliding point
 L_U Deflection leg length

The deflection leg length L_U is calculated using the following formula:

$$L_U = \frac{U \cdot \sqrt{d \cdot \Delta l}}{1000}$$

- L_U Deflection leg length [m]
- d Pipe outside diameter [mm]
- Δl Change in length [m]
- U Material constant (see table 58 on page 37)

Given:

- Product material: CrNiMo steel material number 1.4401
- $U = 34$
- $d = 54 \text{ mm}$
- $\Delta l = 29 \text{ mm}$

Required:

- L_U [m]

Solution:

$$L_B = \frac{C \cdot \sqrt{d \cdot \Delta l}}{1000} \left[\frac{\sqrt{\text{mm} \cdot \text{mm}}}{\frac{\text{mm}}{\text{m}}} = \text{m} \right]$$

$$L_U = \frac{34 \cdot \sqrt{54 \cdot 29}}{1000}$$

$$L_U = 1.35 \text{ m}$$

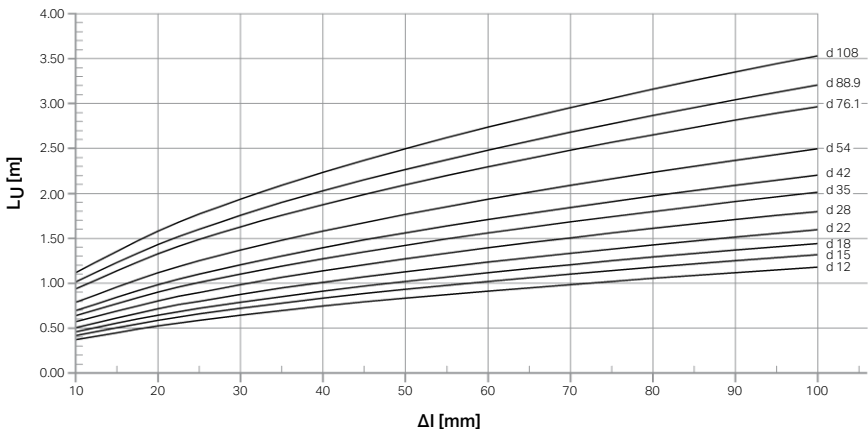

Figure 25: Calculation of the deflection leg length L_U for Geberit Mapress Stainless Steel 1.4401

Calculation of the number of compensators

When compensators are used for expansion compensation, the number of required compensators must be determined.

The calculation of the number of compensators comprises the following steps:

- Calculation of the change in length Δl
- Calculation of the number of compensators N

The following section shows the calculation using sample values for Geberit Mapress Stainless Steel and a compensator with closed bellows.

The number of compensators N is calculated using the following formula:

$$N = \frac{\Delta l}{L_A}$$

L_A Length compensation of the compensator [mm] (L_A is in the catalogue with the expansion fittings)

Δl Change in length [mm]

Given:

- $d = 54$ mm
- $\Delta l = 29$ mm
- L_A with $d = 54$ mm = 14 mm

Required:

- N

Solution:

$$N = \frac{\Delta l}{L_A} \left[\frac{\text{mm}}{\text{mm}} \right]$$

$$N = \frac{29}{14} = 2.1$$

$N = 3$ compensator

Expansion compensation through the bending leg Geberit Mapress Carbon Steel

The expansion of pipes depends on the product material, among other things.

Material-dependent parameters must be considered when calculating the bending leg length. The following table lists the parameters for Geberit Mapress Carbon Steel.

Table 60: Material-dependent parameters for calculating the bending leg length of Geberit Mapress Carbon Steel

Material of pipe	System pipe	Thermal expansion coefficient α [mm/m·K]	Material constant	
			C	U
Non-alloy steel, material number 1.0034	Geberit Mapress Carbon Steel	0.012	55	31

The calculation of the bending leg length comprises the following steps:

- Calculation of the change in length Δl
- Calculation of the bending leg length

The following section shows example values for calculating the bending leg length L_B and L_U for Geberit Mapress Carbon Steel.

Solution:

$$\Delta l = L \cdot \alpha \cdot \Delta T \left[\frac{\text{m} \cdot \text{mm} \cdot \text{K}}{\text{m} \cdot \text{K}} = \text{mm} \right]$$

$$\Delta l = 35\text{m} \cdot 0.012 \frac{\text{mm}}{(\text{m} \cdot \text{K})} \cdot 50\text{K}$$

$$\Delta l = 21 \text{ mm}$$

Calculation of the change in length Δl

The change in length is calculated with the following formula:

$$\Delta l = L \cdot \alpha \cdot \Delta T$$

- Δl Change in length [mm]
- L Pipe length [m]
- ΔT Temperature differential (operating temperature - ambient temperature at time of installation) [K]
- α Thermal expansion coefficient [mm/(m·K)]

Given:

- Product material: Non-alloy steel, material number 1.0034
- $\alpha = 0.012 \text{ mm}/(\text{m} \cdot \text{K})$
- $L = 35 \text{ m}$
- $\Delta T = 50 \text{ K}$

Required:

- Change in length Δl of the pipe [mm]

Table 61: Change in length Δl for Geberit Mapress Carbon Steel system pipe

Pipe length L [m]	Temperature differential ΔT [K]									
	10	20	30	40	50	60	70	80	90	100
	Change in length Δl [mm]									
10	1.2	2.4	3.6	4.8	6.0	7.2	8.4	9.6	10.8	12.0
15	1.8	3.6	5.4	7.2	9.0	10.8	12.6	14.4	16.2	18.0
20	2.4	4.8	7.2	9.6	12.0	14.4	16.8	19.2	21.6	24.0
25	3.0	6.0	9.0	12.0	15.0	18.0	21.0	24.0	27.0	30.0
30	3.6	7.2	10.8	14.4	18.0	21.6	25.2	28.8	32.4	36.0
35	4.2	8.4	12.6	16.8	21.0	25.2	29.4	33.6	37.8	42.0
40	4.8	9.6	14.4	19.2	24.0	28.8	33.6	38.4	43.2	48.0
45	5.4	10.8	16.2	21.6	27.0	32.4	37.8	43.2	48.6	54.0
50	6.0	12.0	18.0	24.0	30.0	36.0	42.0	48.0	54.0	60.0
55	6.6	13.2	19.8	26.4	33.0	39.6	46.2	52.8	59.4	66.0
60	7.2	14.4	21.6	28.8	36.0	43.2	50.4	57.6	64.8	72.0
65	7.8	15.6	23.4	31.2	39.0	46.8	54.6	62.4	70.2	78.0
70	8.4	16.8	25.2	33.6	42.0	50.4	58.8	67.2	75.6	84.0
75	9.0	18.0	27.0	36.0	45.0	54.0	63.0	72.0	81.0	90.0
80	9.6	19.2	28.8	38.4	48.0	57.6	67.2	76.8	86.4	96.0
85	10.2	20.4	30.6	40.8	51.0	61.2	71.4	81.6	91.8	102.0
90	10.8	21.6	32.4	43.2	54.0	64.8	75.6	86.4	97.2	108.0
95	11.4	22.8	34.2	45.6	57.0	68.4	79.8	91.2	102.6	114.0
100	12.0	24.0	36.0	48.0	60.0	72.0	84.0	96.0	108.0	120.0

Calculation of the bending leg length

The calculation of the bending leg length depends on the type of bending leg:

- Expansion compensation through pipe leg / for branch pipe: Calculation of the bending leg length L_B
- Expansion compensation by U-bend: Calculation of the bending leg length L_U

Calculation of the bending leg length L_B

The bending leg length L_B to be calculated is defined as follows with expansion compensation through pipe legs and for branch pipes:

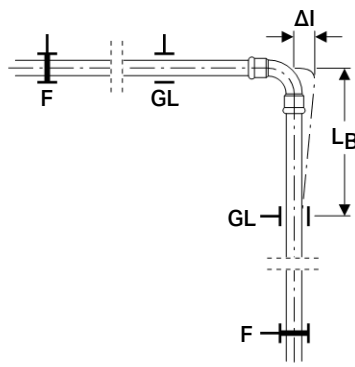

Figure 26: Expansion compensation by pipe leg

- F Anchor point
- GL Sliding point
- L_B Length of the bending leg

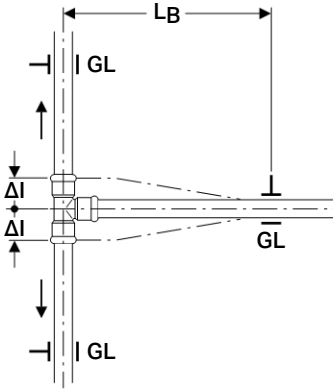

Figure 27: Expansion compensation for branching pipe

- F Anchor point
- GL Sliding point
- L_B Length of the bending leg

The bending leg length L_B is calculated using the following formula:

$$L_B = \frac{C \cdot \sqrt{d \cdot \Delta l}}{1000}$$

- L_B Length of the bending leg [m]
- d Outside pipe diameter [mm]
- Δl Change in length [mm]
- C Material constant (see table 60 on page 42)

Given:

- Product material: Non-alloy steel, material number 1.0034
- C = 55
- d = 54 mm
- Δl = 21 mm

Required:

- L_B [m]

Solution:

$$L_B = \frac{C \cdot \sqrt{d \cdot \Delta l}}{1000} \left[\frac{\sqrt{\text{mm} \cdot \text{mm}}}{\frac{\text{mm}}{\text{m}}} = \text{m} \right]$$

$$L_B = \frac{55 \cdot \sqrt{54 \cdot 21}}{1000}$$

$$L_B = 1.85 \text{ m}$$

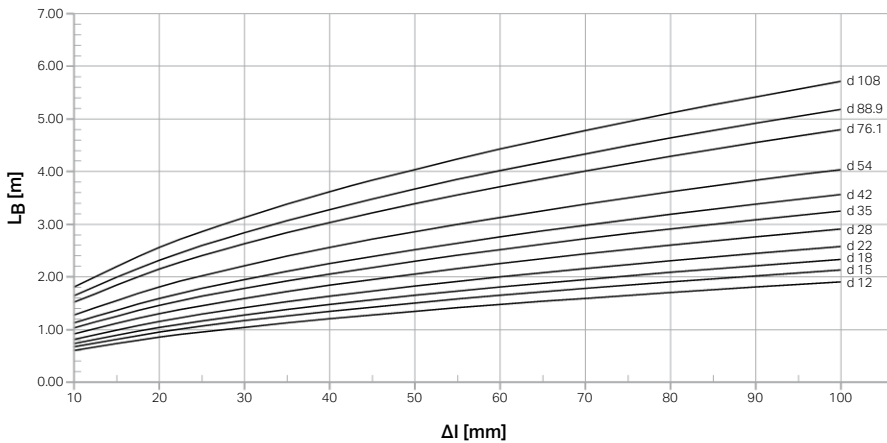

Figure 28: Calculation of the bending leg length L_B for Geberit Mapress Carbon Steel system pipe

Calculation of the bending leg length L_U

The bending leg length L_U to be calculated is defined as follows:

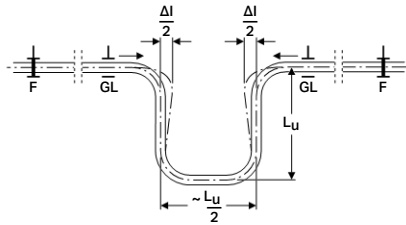

Figure 29: U-bend expansion compensation from bent pipe

- F Anchor point
- GL Sliding point
- L_U Length of the bending leg

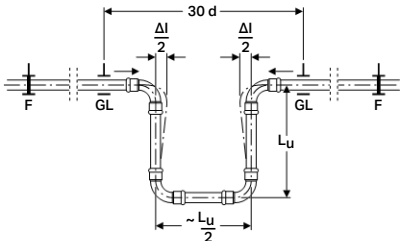

Figure 30: U-bend expansion compensation with press fittings

- F Anchor point
- GL Sliding point
- L_U Length of the bending leg

The bending leg length L_U is calculated using the following formula:

$$L_U = \frac{U \cdot \sqrt{d \cdot \Delta l}}{1000}$$

- L_U Length of the bending leg [m]
- d Outside pipe diameter [mm]
- Δl Change in length [mm]
- U Material constant (see table 60 on page 42)

Given:

- Product material: Non-alloy steel, material number 1.0034
- $U = 31$
- $d = 54 \text{ mm}$
- $\Delta l = 21 \text{ mm}$

Required:

- L_U [m]

Solution:

$$L_U = \frac{U \cdot \sqrt{d \cdot \Delta l}}{1000} \left[\frac{\sqrt{\text{mm} \cdot \text{mm}}}{\frac{\text{mm}}{\text{m}}} = \text{m} \right]$$

$$L_U = \frac{31 \cdot \sqrt{54 \cdot 21}}{1000}$$

$$L_U = 1.04 \text{ m}$$

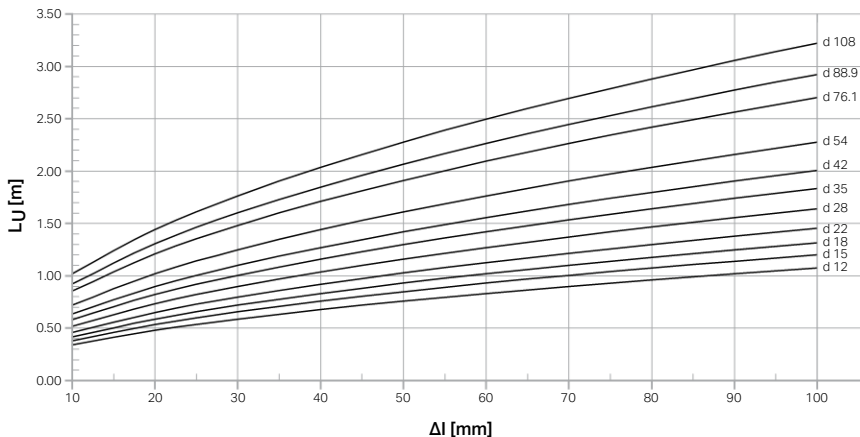

Figure 31: Calculation of the bending leg length L_U for Geberit Mapress Carbon Steel system pipe

Expansion compensation through the bending leg copper

The expansion of pipes depends on the product material, among other things.

Material-dependent parameters must be considered when calculating the bending leg length. The following table lists the settings for copper pipes.

Table 62: Material-dependent parameters for calculating the bending leg length for copper

Material of pipe	Thermal expansion coefficient α [mm/m · K]	Material constant	
		C	U
Copper	0.0166	52	29

The calculation of the bending leg length is comprised of the following steps:

- Calculation of the change in length Δl
- Calculation of the bending leg length

The following section shows sample values for calculating the bending leg length L_B and L_U for copper.

Calculation of the change in length Δl

The change in length is calculated using the following formula:

$$\Delta l = L \cdot \alpha \cdot \Delta T$$

- Δl Change in length [m]
- L Pipe length [m]
- ΔT Temperature differential (operating temperature - ambient temperature at time of installation) [K]
- α Thermal expansion coefficient [mm/(m·K)]

Given:

- Product material: Copper
- $\alpha = 0.0166 \text{ mm}/(\text{m}\cdot\text{K})$
- $L = 35 \text{ m}$
- $\Delta T = 50 \text{ K}$

Required:

- Change in length Δl of the pipe [mm]

Solution:

$$\Delta l = L \cdot \alpha \cdot \Delta T \left[\frac{\text{m} \cdot \text{mm} \cdot \text{K}}{\text{m} \cdot \text{K}} = \text{m} \right]$$

$$\Delta l = 35\text{m} \cdot 0.0166 \frac{\text{mm}}{(\text{m} \cdot \text{K})} \cdot 50\text{K}$$

$$\Delta l = 29 \text{ mm}$$

Table 63: Change in length Δl for copper pipes

Pipe length L [m]	Temperature differential ΔT [K]									
	10	20	30	40	50	60	70	80	90	100
	Change in length Δl [mm]									
10	1.7	3.3	5.0	6.6	8.3	10.0	11.6	13.3	14.9	16.6
15	2.5	5.0	7.5	10.0	12.5	14.9	17.4	19.9	22.4	24.9
20	3.3	6.6	10.0	13.3	16.6	19.9	23.2	26.6	29.9	33.2
25	4.2	8.3	12.5	16.6	20.8	24.9	29.1	33.2	37.4	41.5
30	5.0	10.0	14.9	19.9	24.9	29.9	34.9	39.8	44.8	49.8
35	5.8	11.6	17.4	23.2	29.1	34.9	40.7	46.5	52.3	58.1
40	6.6	13.3	19.9	26.6	33.2	39.8	46.5	53.1	59.8	66.4
45	7.5	14.9	22.4	29.9	37.4	44.8	52.3	59.8	67.2	74.7
50	8.3	16.6	24.9	33.2	41.5	49.8	58.1	66.4	74.7	83.0
55	9.1	18.3	27.4	36.5	45.7	54.8	63.9	73.0	82.2	91.3
60	10.0	19.9	29.9	39.8	49.8	59.8	69.7	79.7	89.6	99.6
65	10.8	21.6	32.4	43.2	54.0	64.7	75.5	86.3	97.1	107.9
70	11.6	23.2	34.9	46.5	58.1	69.7	81.3	93.0	104.6	116.2
75	12.5	24.9	37.4	49.8	62.3	74.7	87.2	99.6	112.1	124.5
80	13.3	26.6	39.8	53.1	66.4	79.7	93.0	106.2	119.5	132.8
85	14.1	28.2	42.3	56.4	70.6	84.7	98.8	112.9	127.0	141.1
90	14.9	29.9	44.8	59.8	74.7	89.6	104.6	119.5	134.5	149.4
95	15.8	31.5	47.3	63.1	78.9	94.6	110.4	126.2	141.9	157.7
100	16.6	33.2	49.8	66.4	83.0	99.6	116.2	132.8	149.4	166.0

Calculation of the bending leg length

The calculation of the bending leg length depends on the type of bending leg:

- Expansion compensation through pipe leg / for branch pipes: Calculation of the bending leg length L_B
- Expansion compensation by U-bend: Calculation of the bending leg length L_U

Calculation of the bending leg length L_B

The bending leg length L_B to be calculated is defined as follows with expansion compensation by pipe legs and for branch pipes:

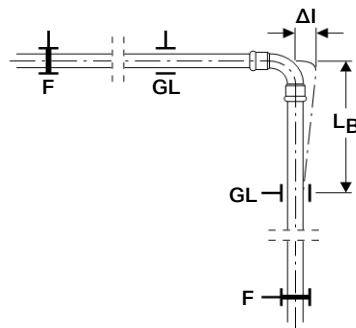

Figure 32: Expansion compensation by pipe leg

- F Anchor point
- GL Sliding point
- L_B Length of the bending leg

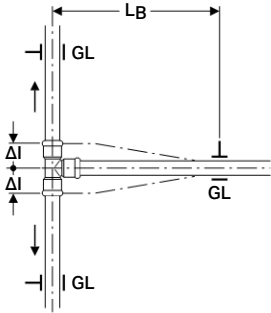

Figure 33: Expansion compensation for branch pipe

F Anchor point

GL Sliding point

L_B Length of the bending leg

The bending leg length L_B is calculated using the following formula:

$$L_B = \frac{C \cdot \sqrt{d \cdot \Delta l}}{1000}$$

L_B Bending leg length [m]

d Pipe outside diameter [mm]

Δl Change in length [m]

C Material constant (see table 62 on page 46)

L Pipe length [m]

Given:

- Product material: Copper
- $C = 52$
- $d = 54 \text{ mm}$
- $\Delta l = 29 \text{ mm}$

Required:

- L_B [m]

Solution:

$$L_B = \frac{C \cdot \sqrt{d \cdot \Delta l}}{1000} \left[\frac{\sqrt{\text{mm} \cdot \text{mm}}}{\text{mm}} = \text{m} \right]$$

$$L_B = \frac{52 \cdot \sqrt{54 \cdot 29}}{1000} \text{ m}$$

$$L_B = 2.06 \text{ m}$$

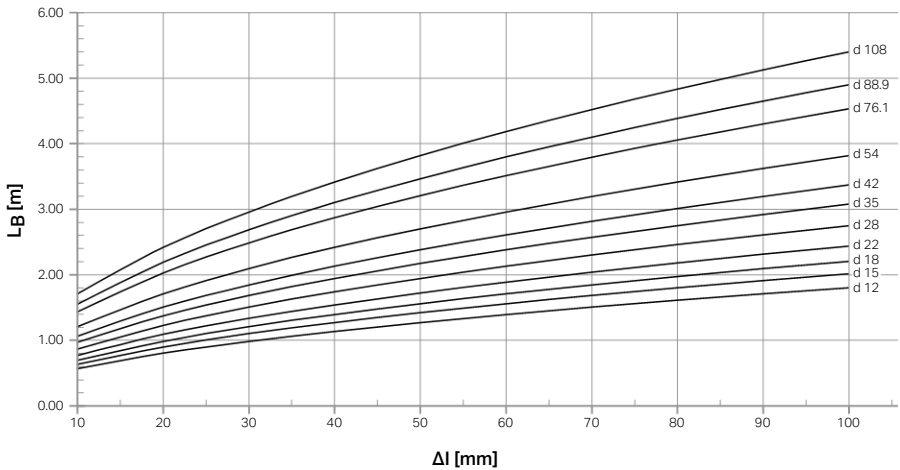

Figure 34: Calculation of the bending leg length L_B for copper pipes in accordance with DVGW GW 392

Calculation of the bending leg length L_U

The bending leg length L_U to be calculated is defined as follows:

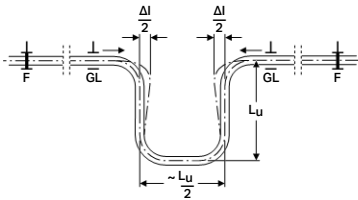

Figure 35: U-bend expansion compensation from bent pipe

- F Anchor point
- GL Sliding point
- L_U Length of the bending leg

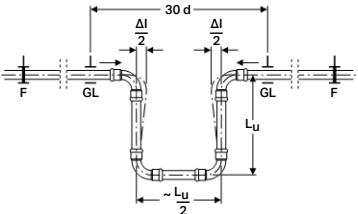

Figure 36: U-bend expansion compensation by press fittings

- F Anchor point
- GL Sliding point
- L_U Length of the bending leg

The bending leg length L_U is calculated using the following formula:

$$L_U = \frac{U \cdot \sqrt{d \cdot \Delta l}}{1000}$$

- L_U Bending leg length [m]
- d Pipe outside diameter [mm]
- Δl Change in length [mm]
- U Material constant (see table 62 on page 46)
- L Pipe length [m]

Given:

- Product material: Copper
- $U = 29$
- $d = 54$ mm
- $\Delta l = 29$ mm

Required:

- L_U [m]

Solution:

$$L_U = \frac{U \cdot \sqrt{d \cdot \Delta l}}{1000} \left[\frac{\sqrt{\text{mm} \cdot \text{mm}}}{\frac{\text{mm}}{\text{m}}} = \text{m} \right]$$

$$L_U = \frac{29 \cdot \sqrt{54 \cdot 29}}{1000} \text{ m}$$

$$L_U = 1.15 \text{ m}$$

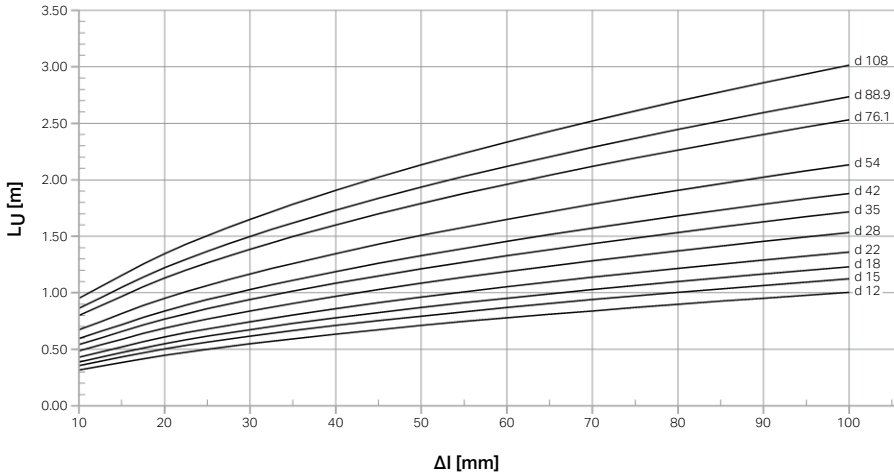

Figure 37: Calculation of the bending leg length L_U for copper pipes in accordance with DVGW GW 392

Expansion compensation through the bending leg Geberit MapressCuNiFe

The expansion of pipes depends, amongst others, on the type of product material. Material-dependent parameters must be considered when calculating the length of the bending leg. The following table lists the parameters for Geberit MapressCuNiFe.

Table 64: Material-dependent parameters for calculating the bending leg length of Geberit MapressCuNiFe

Material of pipe	System pipe	Thermal expansion coefficient α [mm/m·K]	Material constant	
			C	U
Copper-nickel forging alloy 2.1972.11	Geberit MapressCuNiFe	0.017	54	31

The calculation of the bending leg length comprises the following steps:

- Calculation of the change in length Δl
- Calculation of the bending leg length

The following section shows example values for calculating the bending leg length L_W and L_U for Geberit MapressCuNiFe.

Calculation of the change in length Δl

The change in length is determined with the following formula:

$$\Delta l = L \cdot \alpha \cdot \Delta T$$

- Δl : Change in length [m]
 L: Pipe length [m]
 ΔT : Temperature differential (operating temperature - ambient temperature at time of installation) [K]
 α : Coefficient of thermal expansion [mm/(m·K)]

Given:

- Product material: CuNi, material number 2.1972.11
- $\alpha = 0.017$ mm/(m·K)
- $L = 5$ m
- $\Delta T = 50$ K

Required:

- Change in length Δl of the pipe [mm]

Solution:

$$\Delta l = L \cdot \alpha \cdot \Delta T \left[\frac{\text{m} \cdot \text{m} \cdot \text{K}}{\text{m} \cdot \text{K}} = \text{m} \right]$$

$$\Delta l = 5 \text{ m} \cdot 0.017 \frac{\text{mm}}{\text{m} \cdot \text{K}} \cdot 50 \text{ K}$$

$$\Delta l = 4.3 \text{ mm}$$

Table 65: Change in length Δl for Geberit MapressCuNiFe system pipe

Pipe length L [m]	Temperature differential ΔT [K]									
	10	20	30	40	50	60	70	80	90	100
	Change in length Δl [mm]									
1	0.17	0.34	0.51	0.68	0.85	1.02	1.19	1.36	1.53	1.70
2	0.34	0.68	1.02	1.36	1.70	2.04	2.38	2.72	3.06	3.40
3	0.51	1.02	1.53	2.04	2.55	3.06	3.57	4.08	4.59	5.10
4	0.68	1.36	2.04	2.72	3.40	4.08	4.76	5.44	6.12	6.80
5	0.85	1.70	2.55	3.40	4.25	5.10	5.95	6.80	7.65	8.50
6	1.02	2.04	3.06	4.08	5.10	6.12	7.14	8.16	9.18	10.20
7	1.19	2.38	3.57	4.76	5.95	7.14	8.33	9.52	10.71	11.90
8	1.36	2.72	4.08	5.44	6.80	8.16	9.52	10.88	12.24	13.60
9	1.53	3.06	4.59	6.12	7.65	9.18	10.71	12.24	13.77	15.30
10	1.70	3.40	5.10	6.80	8.50	10.20	11.90	13.60	15.30	17.00

Calculation of the bending leg length

The calculation of the bending leg length depends on the type of bending leg:

- Expansion compensation through pipe leg / for branch pipes: Calculation of the bending leg length L_B
- Expansion compensation by U-bends: Calculation of the bending leg length L_U

Calculation of the bending leg length L_B

The bending leg length L_W to be calculated is defined as follows with expansion compensation through pipe legs and for branch pipes:

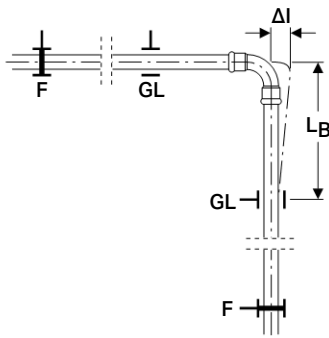

Figure 38: Expansion compensation by pipe leg

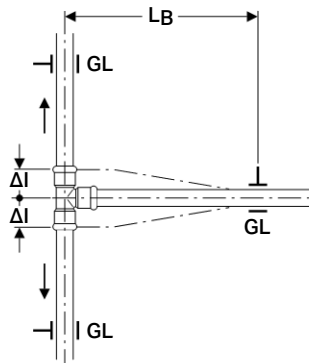

Figure 39: Expansion compensation for branching pipe

- F Anchor point
- GL Sliding point
- L_B Length of the bending leg

The bending leg length L_B is determined with the following formula:

$$L_B = C \cdot \sqrt{d \cdot \Delta l}$$

- L_B Length of the bending leg [m]
- d Outside pipe diameter [mm]
- Δl Change in length [m]
- C Material constant (see table 64 on page 50)
- L Pipe length [m]

Given:

- Product material: CuNi, material number CW 352H
- $C = 54$
- $d = 54$ mm
- $\Delta l = 0.0043$ m

Required:

- L_B [m]

Solution:

$$L_B = C \cdot \sqrt{d \cdot \Delta l} \quad [\sqrt{m \cdot m} = m]$$

$$L_B = 54 \cdot \sqrt{0.054 \cdot 0.0430}$$

$$L_B = 0.82 \text{ mm}$$

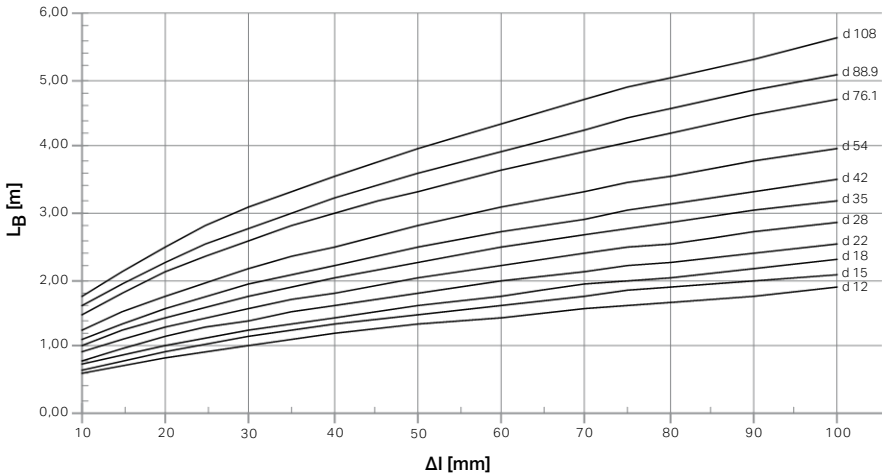

Figure 40: Determination of the bending leg length L_B for Geberit MapressCuNiFe system pipe

Calculation of the bending leg length L_U

The bending leg length L_U to be calculated is defined with the following formula:

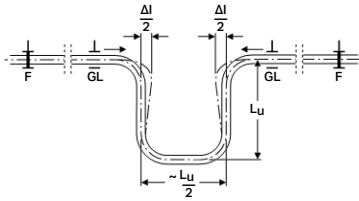

Figure 41: U-bend expansion compensation from bent pipe

- F Anchor point
- GL Sliding point
- L_U Length of the bending leg

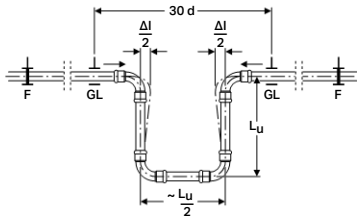

Figure 42: U-bend expansion compensation with pressfittings

- F Anchor point
- GL Sliding point
- L_U Length of the bending leg

The bending leg length L_U is determined with the following formula:

$$L_U = U \cdot \sqrt{d \cdot \Delta l}$$

- L_U Length of the bending leg [m]
- d Outside pipe diameter [mm]
- Δl Change in length [m]
- U Material constant (see table 64 on page 50)
- L Pipe length [m]

Given:

- Product material: CuNi, material number 2.1972.11
- $U = 31$
- $d = 54 \text{ mm}$
- $\Delta l = 0.0043 \text{ m}$

Required:

- L_U [m]

Solution:

$$L_U = U \cdot \sqrt{d \cdot \Delta l} \left[\sqrt{\text{m} \cdot \text{m}} = \text{m} \right]$$

$$L_U = 31 \cdot \sqrt{0.054 \cdot 0.0430}$$

$$L_U = 0.47 \text{ mm}$$

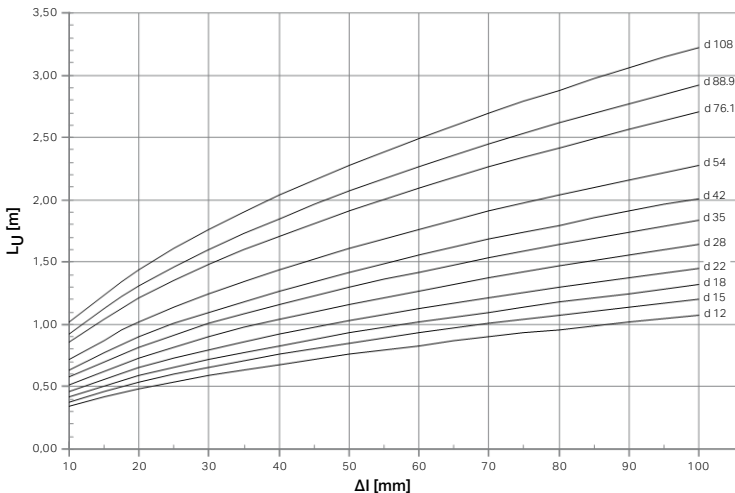

Figure 43: Determination of the bending leg length L_U for Geberit MapressCuNiFe system pipe

1.4.3 Fastening of pipes

Pipe fastenings

Pipe fastenings fulfil various functions: Apart from supporting the pipe they also direct the temperature-related changes in length in the required direction.

Pipe fastenings are categorised according to the purpose they serve:

- **Anchor point** = rigid fixture of the pipe
- **Sliding point** = axially movable pipe bracket

- i**
- Sliding points must be set so that they do not become unwanted anchor points during operation
 - Do not attach anchor points or sliding points to pressfittings

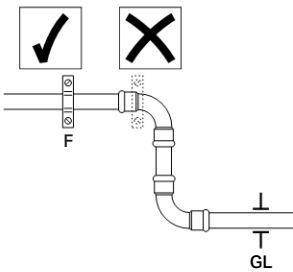

Figure 44: Positioning anchor points: On the pipe, not on the pressfitting

F Anchor point
GL Sliding point

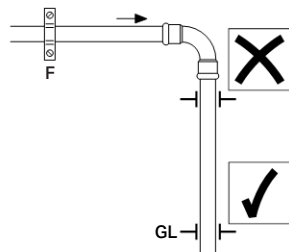

Figure 45: Positioning sliding points: Horizontal pipe must be able to expand freely

F Anchor point
GL Sliding point

Connection pipes (e.g. to radiators) must be sufficiently long to accommodate the changes in length occurring in the pipe system.

In the case of branch pipes or changes in direction, when mounting the first sliding point, the minimum spacing is determined by the bending leg resulting from the change in length (L_B / L_U).

A pipe run which is not interrupted by a change in direction or does not contain any expansion compensation should only be installed with an anchor point. On long pipe runs it is recommended, for example, to set an anchor point in the middle of the pipe run in order to direct the expansion in two directions.

This situation exists, for example, if there are vertical sections extending over several intermediate floors without any expansion compensation.

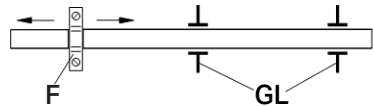

Figure 46: Fastening of continuous pipes with only one anchor point

GL Sliding points
F Anchor points

Due to the fact that the riser section should be fastened in the middle, the thermal expansion is directed in two directions and the strain on the branch fittings is reduced.

Pipe bracket spacing

Commercially available pipe brackets can be used for fastening the pipes. The necessary pipe bracket spacing is listed in the following table.

Table 66: Pipe bracket spacing according to DIN 806-4 for Geberit Mapress Stainless Steel, Carbon Steel, Copper and CuNiFe system pipes (DIN EN 10305)

DN	d x s [mm]	Pipe bracket spacing [m]	Pipe bracket spacing recommended by Geberit [m]
12	15 x 1.2	1.25	1.50
15	18 x 1.2	1.50	1.50
20	22 x 1.2	2.00	2.50
25	28 x 1.5	2.25	2.50
32	35 x 1.5	2.75	3.50
40	42 x 1.5	3.00	3.50
50	54 x 1.5	3.50	3.50
65	76.1 x 2.0	4.25	5.00
80	88.9 x 2.0	4.75	5.00
100	108 x 2.0	5.00	5.00

Pipe brackets with rubber liners should be used for acoustically insulating the pipe from the building structure.

1.4.4 Heat emission

Use of the emitted or absorbed thermal energy

In addition to transporting the thermal medium (water, steam etc.), pipes also emit the thermal energy due to physical laws. This effect can also be reversed.

Pipes can therefore be used for heat emission (underfloor heating, heating ceilings, heating walls etc.) and also for thermal absorption (cooling water systems, geothermal heat storage etc.).

Calculated determination of the heat emission of Geberit Mapress Stainless Steel

The calculated determination of the heat emission is comprised of the following steps:

- Calculation of the heat transfer coefficient k_r
- Calculation of the heat emission \dot{Q}_R

Calculation of the thermal transfer coefficient k_r

General calculation

Assumptions for general calculation:

- Surface-mounted
- Stationary air

The heat transfer coefficient k_r is determined in the general calculation using the following formula:

$$k_r = \frac{\pi}{\frac{1}{\alpha_i \cdot d_i} + \frac{1}{2 \cdot \lambda} \cdot \ln \frac{d_a}{d_i} + \frac{1}{\alpha_a \cdot d_a}}$$

α_i Heat transfer coefficient, inside [W/(m²·K)]

α_a Heat transfer coefficient, outside [W/(m²·K)]

d_a Outer diameter [mm]

d_i Inside diameter [mm]

λ Thermal conductivity [W/(m·K)]

Values for Geberit Mapress Stainless Steel:

- $\alpha_i = 23.2 \text{ W/(m}^2 \cdot \text{K)}$
- $\alpha_a = 8.1 \text{ W/(m}^2 \cdot \text{K)}$
- $\lambda = 15 \text{ W/(m} \cdot \text{K)}$

Simplified calculation

Assumptions for the simplified calculation:

- Surface-mounted
- Stationary air
- Radiant proportion not taken into account

The heat transfer coefficient k_r is determined in the simplified calculation using the following formula:

$$k_r = \frac{\pi}{\alpha_a \cdot d_a}$$

α_a Heat transfer coefficient, outside
[W/(m²·K)]

Values for Geberit Mapress Stainless Steel:

- $\alpha_a = 8.1$ W/(m²·K)

Calculation of the heat emission \dot{Q}_R

The heat emission is calculated using the following formula:

$$\dot{Q}_R = (T_i - T_a) \cdot k_r$$

- \dot{Q}_R Heat flow for 1 m pipe [W/m]
- k_r Heat transfer coefficient [W/m·K]
- T_i Water temperature in the pipe
- T_a Room temperature

Tabulated determination of the heat emission

The values of the heat flow \dot{Q}_R in the following table are based on the general calculation of the heat transfer coefficients k_r .

Table 67: Heat emission of Geberit Mapress Stainless Steel

d x s [mm]	Temperature differential ΔT [K]									
	10	20	30	40	50	60	70	80	90	100
	Heat flow \dot{Q}_R [W/m]									
15 x 1.0	3.2	7.4	12.2	17.4	22.9	28.7	34.8	41.2	47.7	54.5
18 x 1.0	3.7	8.6	14.1	20.1	26.5	33.2	40.3	47.6	55.2	63.1
22 x 1.2	4.3	10.0	16.5	23.5	31.0	38.9	47.2	55.8	64.7	73.9
28 x 1.2	5.2	12.2	20.0	28.5	37.5	47.1	57.1	67.5	78.3	89.5
35 x 1.5	6.2	14.5	23.8	34.0	44.8	56.2	68.2	80.7	93.6	107.0
42 x 1.5	7.2	16.8	27.6	39.3	51.8	65.0	78.8	93.3	108.2	123.8
54 x 1.5	9.0	20.8	34.2	48.7	64.3	80.7	97.8	115.8	134.4	153.7
54 x 2.0	8.9	20.8	34.2	48.7	64.2	80.6	97.8	115.7	134.3	153.5
76.1 x 2.0	11.6	26.9	44.2	63.0	83.1	104.3	126.5	149.7	173.9	198.9
88.9 x 2.0	13.1	30.5	50.0	71.3	94.0	118.1	143.2	169.5	196.9	225.3
108 x 2.0	15.4	35.6	58.4	83.3	109.8	137.9	167.4	198.1	230.1	263.3

Graphical determination of the heat emission

The values of the heat flow \dot{Q}_R that can be derived from the following figure are based on the general calculation of the heat transfer coefficients k_r .

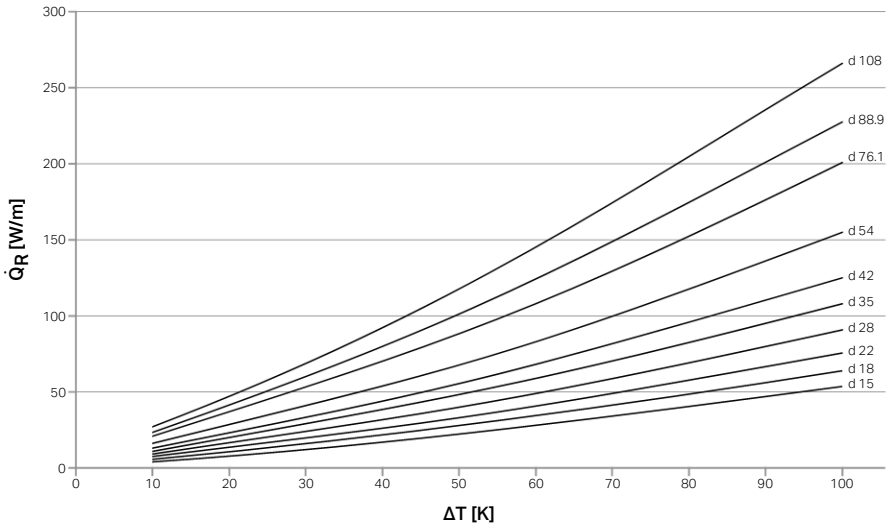

Figure 47: Heat emission of Geberit Mapress Stainless Steel

\dot{Q}_R Heat flow for 1 m pipe

ΔT Temperature differential

Calculated determination of the heat emission of Geberit Mapress Carbon Steel

The calculative determination of the thermal emission consists of the following steps:

- Calculation of the thermal transfer coefficient k_r
- Calculation of the thermal emission \dot{Q}_R

Calculation of the thermal transfer coefficient k_r

General calculation

Assumptions for general calculation:

- Surface-mounted
- Stationary air

The thermal transfer coefficient k_r will be determined in the general calculation with the following formula:

$$k_r = \frac{\pi}{\frac{1}{\alpha_i \cdot d_i} + \frac{1}{2 \cdot \lambda} \cdot \ln \frac{d_a}{d_i} + \frac{1}{\alpha_a \cdot d_a}}$$

- α_i Heat transfer coefficient, inside [W/(m²·K)]
- α_a Heat transfer coefficient, outside [W/(m²·K)]
- d_a Outside diameter [mm]
- d_i Inside diameter [mm]
- λ Thermal conductivity [W/(m·K)]

Values for Geberit Mapress Carbon Steel:

- $\alpha_i = 23.2$ W/(m²·K)
- $\alpha_a = 8.1$ W/(m²·K)
- $\lambda = 60$ W/(m·K)

Simplified calculation

Assumptions for the simplified calculation:

- Surface-mounted
- Stationary air
- Radiant proportion not taken into account

The thermal transfer coefficient k_r will be calculated in the simplified calculation with the following formula:

$$k_r = \frac{\pi}{\alpha_a \cdot d_a}$$

- α_a Heat transfer coefficient, outside [W/(m²·K)]

Value for Geberit Mapress Carbon Steel:

- $\alpha_a = 8.1$ W/(m²·K)
- $\lambda = 60$ W/(m·K)

Calculation of the thermal emission \dot{Q}_R

The thermal emission is determined with the following formula:

$$\dot{Q}_R = (T_i - T_a) \cdot k_r$$

- \dot{Q}_R Heat flow for 1 m pipe [W/m]
- k_r Heat transfer coefficient [W/m·K]
- T_i Water temperature in the pipe
- T_a Room temperature

Tabulation determination of the thermal emission

The values of the thermal flow \dot{Q}_R in the following table are based on the general calculation of the thermal transfer coefficients k_r .

Table 68: Thermal emission of Geberit Mapress Carbon Steel

d x s [mm]	Temperature differential ΔT [K]									
	10	20	30	40	50	60	70	80	90	100
	Heat flow \dot{Q}_R [W/m]									
12 x 1.2	3.9	8.9	14.5	20.6	27.2	34.2	41.6	49.4	57.6	66.2
15 x 1.2	4.7	10.7	17.5	24.9	32.8	41.2	50.2	59.6	69.5	79.9
18 x 1.2	5.5	12.5	20.4	29.0	38.2	48.1	58.5	69.5	81.1	93.2
22 x 1.5	6.3	14.3	23.3	33.1	43.6	54.8	66.8	79.3	92.6	106.5
28 x 1.5	7.8	17.6	28.7	40.7	53.7	67.5	82.2	97.7	114.0	131.2
35 x 1.5	9.5	21.5	34.9	49.5	65.3	82.1	100.0	118.9	138.8	159.8
42 x 1.5	11.2	25.2	40.8	58.0	76.4	96.1	117.0	139.2	162.5	187.1
54 x 1.5	14.4	32.3	52.5	74.5	98.2	123.6	150.5	178.9	209.0	240.6
76.1 x 1.5	19.2	43.1	69.8	99.0	130.5	164.2	200.0	237.9	278.0	320.2
88.9 x 2.0	22.0	49.3	79.9	113.3	149.3	187.8	228.7	272.2	318.1	366.5
108 x 2.0	26.1	58.4	94.6	134.1	176.7	222.2	270.8	322.2	376.7	434.1

Graphical determination of the thermal emission

The values of the thermal flow \dot{Q}_R that can be determined from the following figure are based on the general calculation of the thermal transfer coefficients k_r .

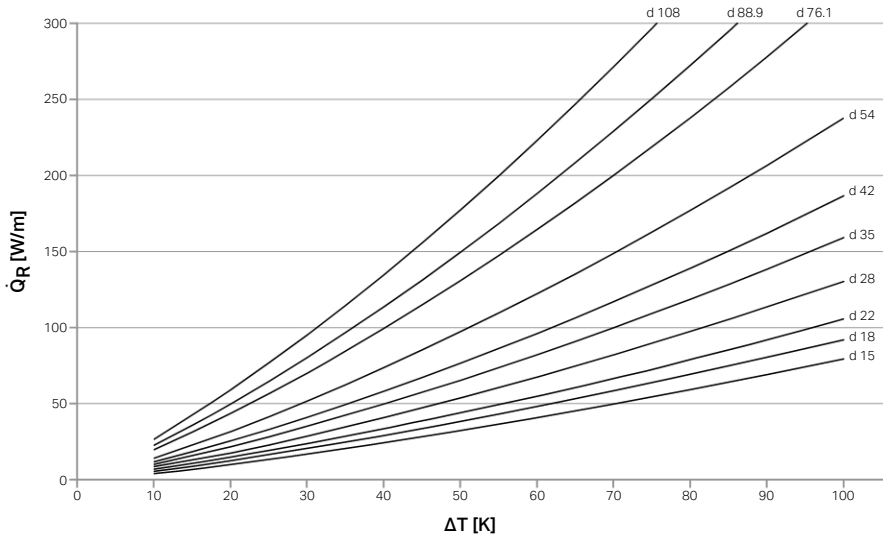

Figure 48: Thermal emission of Geberit Mapress Carbon Steel

\dot{Q}_R Heat flow for 1 m pipe

ΔT Temperature differential

Calculated determination of the heat emission of copper

The calculated determination of the heat emission is comprised of the following steps:

- Calculation of the thermal transfer coefficient k_r
- Calculation of the heat emission \dot{Q}_R

Calculation of the thermal transfer coefficient k_r

General calculation

Assumptions for the general calculation:

- Exposed mounting
- Stationary air

The thermal transfer coefficient k_r is determined in the general calculation using the following formula:

$$k_r = \frac{\pi}{\frac{1}{\alpha_i \cdot d_i} + \frac{1}{2 \cdot \lambda} \cdot \ln \frac{d_a}{d_i} + \frac{1}{\alpha_a \cdot d_a}}$$

α_i Heat transfer coefficient, inside [W/(m²·K)]

α_a Heat transfer coefficient, outside [W/(m²·K)]

d_a Outside diameter [mm]

d_i Inside diameter [mm]

λ Thermal conductivity [W/(m·K)]

Values for copper:

- $\alpha_i = 23.2$ W/(m²·K)
- $\alpha_a = 8.1$ W/(m²·K)
- $\lambda = 305$ W/(m·K)

Simplified calculation

Assumptions for the simplified calculation:

- Exposed mounting
- Stationary air
- Radiant proportion not taken into account

The thermal transfer coefficient k_r is determined in the simplified calculation using the following formula:

$$k_r = \frac{\pi}{\frac{1}{\alpha_a \cdot d_a}}$$

α_a Heat transfer coefficient, outside [W/(m²·K)]

Values for copper:

- $\alpha_a = 8.1$ W/(m²·K)

Calculation of the heat emission \dot{Q}_R

The heat emission is calculated using the following formula:

$$\dot{Q}_R = (T_i - T_a) \cdot k_r$$

\dot{Q}_R Heat flow for 1 m pipe [W/m]

k_r Thermal transfer coefficient [W/m·K]

T_i Water temperature in the pipe

T_a Room temperature

Tabulated determination of the heat emission

The values of the heat flow \dot{Q}_R in the following tables are based on the general calculation of the thermal transfer coefficients k_r .

Table 69: Heat emission for copper pipes in accordance with DVGW GW 392

d [mm]	Temperature differential ΔT [K]									
	10	20	30	40	50	60	70	80	90	100
	Heat flow \dot{Q} [W/m]									
12	3.8	8.5	13.9	19.7	25.9	32.6	39.6	46.9	54.7	62.8
15	4.6	10.3	16.8	23.8	31.3	39.4	47.8	56.8	66.2	76.0
18	5.3	12.1	19.6	27.8	36.6	46.0	55.9	66.3	77.3	88.8
22	6.3	14.3	23.2	33.0	43.4	54.5	66.3	78.7	91.8	105.5
28	7.8	17.6	28.5	40.5	53.3	66.9	81.4	96.7	112.7	129.6
35	9.5	21.3	34.5	49.0	64.5	81.0	98.6	117.1	136.6	157.1
42	10.8	24.3	39.4	55.9	73.6	92.5	112.5	133.7	156.0	179.6
54	13.8	30.9	50.1	71.0	93.6	117.6	143.1	170.1	198.5	228.5
76.1	18.6	41.6	67.4	95.5	125.8	158.2	192.5	228.9	267.4	307.8
88.9	21.3	47.6	77.1	109.3	144.0	181.0	220.4	262.1	306.1	352.5
108	25.3	56.5	91.4	129.5	170.5	214.3	261.0	310.4	362.7	417.8

Graphical determination of heat emission

The values of the heat flow \dot{Q}_R that can be derived from the following graphs are based on the general calculation of the thermal transfer coefficients k_r .

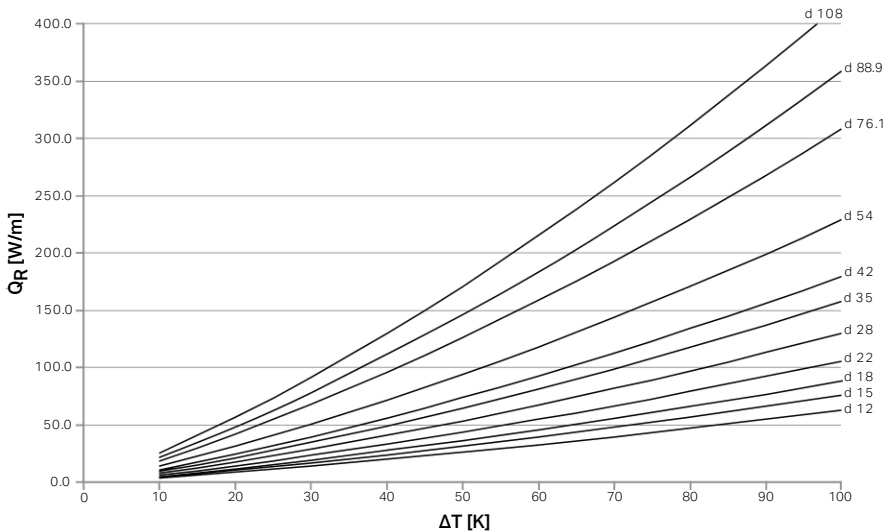

Figure 49: Heat emission for copper pipes in accordance with DVGW GW 392

\dot{Q}_R Heat flow for 1 m pipe

ΔT Temperature differential

Calculated determination of the heat emission of Geberit MapressCuNiFe

The calculative determination of the heat emission comprises the following steps:

- Calculation of the thermal transfer coefficient k_r
- Calculation of the thermal emission \dot{Q}_R

Calculation of the thermal transfer coefficient k_r

General calculation

Assumptions for general calculation:

- Surface-mounted
- Stationary air

The thermal transfer coefficient k_r will be determined in the general calculation with the following formula:

$$k_r = \frac{\pi}{\frac{1}{\alpha_i \cdot d_i} + \frac{1}{2 \cdot \lambda} \cdot \ln \frac{d_a}{d_i} + \frac{1}{\alpha_a \cdot d_a}}$$

α_i Heat transfer coefficient, inside [W/(m²·K)]

α_a Heat transfer coefficient, outside [W/(m²·K)]

d_a Outside diameter [mm]

d_i Inside diameter [mm]

λ Thermal conductivity [W/(m·K)]

Values for Geberit MapressCuNiFe:

- $\alpha_i = 23.2$ W/(m²·K)
- $\alpha_a = 8.1$ W/(m²·K)
- $\lambda = 50$ W/(m·K)

Simplified calculation

Assumptions for the simplified calculation:

- Surface-mounted
- Stationary air
- Radiant proportion not taken into account

The thermal transfer coefficient k_r will be calculated in the simplified calculation with the following formula:

$$k_r = \frac{\pi}{\frac{1}{\alpha_a \cdot d_a}}$$

α_a Heat transfer coefficient, outside [W/(m²·K)]

Values for Geberit MapressCuNiFe:

- $\alpha_a = 8.1$ W/(m²·K)
- $\lambda = 50$ W/(m·K)

Calculation of the thermal emission \dot{Q}_R

The thermal emission is determined with the following formula:

$$\dot{Q}_R = (T_i - T_a) \cdot k_r$$

\dot{Q}_R Heat flow for 1 m pipe [W/m]

k_r Heat transfer coefficient [W/m·K]

T_i Water temperature in the pipe

T_a Room temperature

Tabulation calculation of the heat emission

The values of the thermal flow \dot{Q}_R in the following table are based on the general calculation of the thermal transfer coefficients k_r .

Table 70: Heat emission of Geberit MapressCuNiFe

d x s [mm]	Temperature differential ΔT [K]									
	10	20	30	40	50	60	70	80	90	100
	Heat flow \dot{Q} [W/m]									
15 x 1.0	4.6	10.3	16.8	23.8	31.3	39.4	47.8	56.8	66.1	76.0
22 x 1.0	6.3	14.3	23.2	33.0	43.4	54.5	66.3	78.7	91.8	105.5
28 x 1.0	7.8	17.6	28.5	40.4	53.3	66.9	81.4	96.7	112.7	129.6
35 x 1.0	9.5	21.3	34.5	49.0	64.5	81.0	98.6	117.1	136.6	157.1
42 x 1.5	11.1	24.9	40.4	57.2	75.4	94.7	115.3	137.0	159.8	183.9
54 x 1.5	13.9	31.2	50.7	71.8	94.6	118.9	144.7	171.9	200.7	230.9
76.1 x 2.0	18.6	41.6	67.3	95.4	125.7	158.0	192.3	228.6	267.0	307.4
88.9 x 2.0	21.3	47.6	77.1	109.3	144.0	181.0	220.3	262.0	306.1	352.5
108 x 2.5	25.3	56.5	91.4	129.4	170.5	214.3	261.0	310.4	362.6	417.8

Graphical calculation of the heat emission

The values of the thermal flow \dot{Q}_R that can be calculated from the following figure are based on the general calculation of the thermal transfer coefficients k_r .

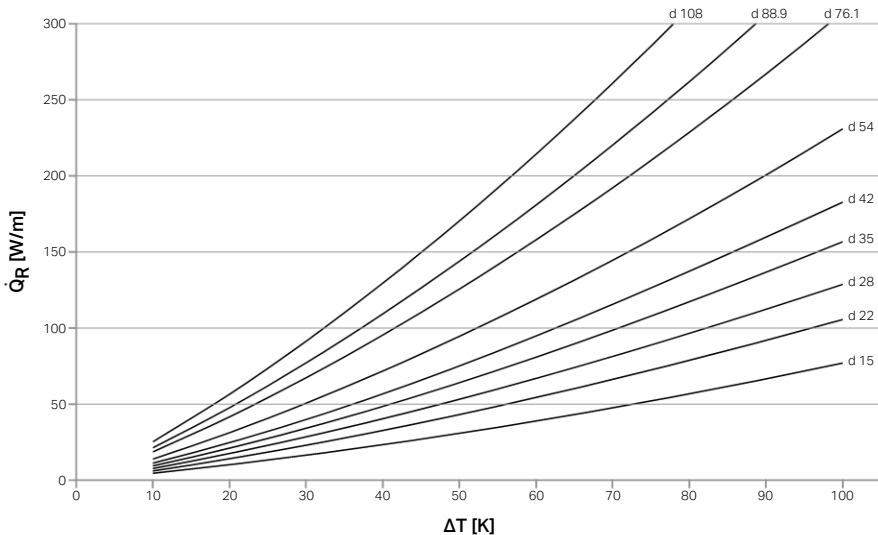

Figure 50: Heat emission Geberit MapressCuNiFe

\dot{Q}_R Heat flow for 1 m pipe

ΔT Temperature differential

1.4.5 Pressure loss tables

Pressure loss tables for the different applications of the Geberit Mapress pressfitting systems can be accessed in the Internet under www.international.geberit.com.

1.5 Operation

1.5.1 Geberit pressing tools

Always use approved Geberit pressing tools. Please contact Geberit if you are unsure if the tool you are using is compatible with Geberit Mapress.

The instructions for use of each pressing tool must always be observed.

Maintenance of Geberit pressing tools

Always follow the service intervals indicated on the operating instructions of the Geberit pressing tool. Check the tool regularly for visible defects and damage that could affect safety, and regularly clean and lubricate it.

The service interval for the tool is indicated by a sticker on the machine. Always service and recalibrate before this date at the latest.

1.5.2 Geberit pressing jaw

Basic safety notes



WARNING

Risk of injury from incorrect handling

- ▶ Only use the pressing jaw if it is in perfect working order. People without technical training are only allowed to use the pressing jaw provided that they have been instructed by a trained specialist.
- ▶ Danger of crushing by moving parts: Keep body parts or other objects clear of the pressing jaw and pressfitting during the pressing operation. Do not hold the adaptor or pressing jaw with your hands during the pressing operation.



CAUTION

Risk of property damage from incorrect handling

- ▶ Replace worn pressing jaw.
- ▶ Use the transport case for transport and storage, and store the pressing jaw in a dry room.
- ▶ Have any damage inspected immediately by an authorised specialist workshop.
- ▶ Observe the safety notes for the cleaning and anti-corrosion protection agents used.

Operating the Geberit Mapress pressing jaw



CAUTION

Leaking connection due to incorrect pressing

- ▶ Clean away any dirt, chips or other debris from between the pressing jaw and the pressfitting.
- ▶ Observe recommended preparation procedures prior to pressing operation.
- ▶ Ensure that the pressing jaw is completely closed after the pressing sequence.
- ▶ Have any pressing jaw which does not close completely checked for damage.

- 1 Ensure the diameter of the pressfitting matches the diameter of the pressing jaw.
- 2 Press the jaw levers together to open the pressing jaw.
- 3 Place the pressing jaw onto the bead of the pressfitting.

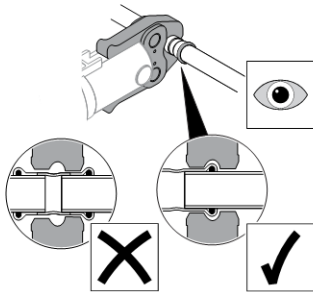

- 4 Release the jaw lever.
- 5 Press the pressfitting (see operating instructions of the pressing tool for correct sequence).
- 6 Open the pressing jaw and remove the pressfitting.
- 7 If correctly pressed, it will be possible to peel away the pressing indicator foil off the fitting.

Maintenance schedule (jaws)

An inspection sticker on the pressing jaw indicates the date when the next calibration is due. For information about Geberit Mapress tool service agents, please contact your local Geberit sales representative.

Table 71: Maintenance interval

Interval	Maintenance work
Regularly, before use at the beginning of the day	<ul style="list-style-type: none"> • Check the pressing jaw for externally visible defects, damage and signs of wear that could effect safety, and if necessary, take it to an authorised service agent • Clean and lubricate the pressing jaw with general purpose spray lubricant • Check that the jaw levers can move easily
Every year	<ul style="list-style-type: none"> • Have an authorised service agent check and re-calibrate the tool

1.5.3 Geberit Mapress pressing collar and adaptor

Fitting the pressing collar around the pressfitting

Basic safety notes

WARNING
Risk of injury caused by flying fragments if used incorrectly or if worn or damaged pressing collars and adaptor jaws are used

- ▶ Only use the pressing collar and adaptor jaw if they are in perfect working order.
- ▶ Take pressing collars and adaptor jaws displaying material cracks out of service immediately and do not continue to use them.
- ▶ The maintenance schedule and maintenance intervals must be adhered to.
- ▶ Pressing collars and adaptor jaws may only be used by skilled persons.

CAUTION
Danger of crushing by moving parts

- ▶ Do not place any parts of your body or other objects in between the pressing collar and the adaptor jaw.
- ▶ Do not hold the pressing collar or adaptor jaw with your hands during the pressing sequence.

Operating the Geberit Mapress pressing collar adaptor

Different adaptors for pressing collars must be used depending on the nominal diameter of the pressfitting.

Table 72: Adaptors

Nominal diameter [mm]	Adaptor for pressing collar	Collar	Pressing tool
35	ZB 203	691.181.00.1	EFP 202,
42	(compatibility 2)	691.182.00.1	ECO 202
54	or ZB 303	691.183.00.1	ACO 202
66.7	(compatibility 3)	691.185.00.1	ECO 301
76.1	ZB 321	90671	ECO 301
88.9		90672	
108	ZB 321 and ZB 322	90673	ECO 301

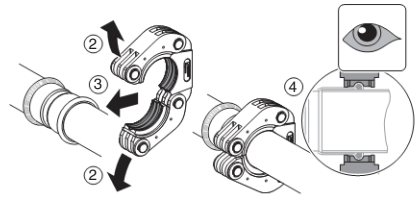

CAUTION
Leaking connection due to failed pressing sequence

- ▶ Make sure that the pressing collar is completely closed after the pressing sequence.
- ▶ Have any pressing collars that have not been closed completely, as well as the adaptor jaw and pressing tool, inspected for damage by an authorized service agent.
- ▶ Replace any connection that have not been pressed correctly and do not attempt corrective pressing.
- ▶ If there are any burns on the pressfitting after the pressing sequence, have the pressing collar inspected by an authorized service agent.

35, 42, 54 and 66.7 mm collars

- 1 Ensure the diameter of the pressfitting matches the diameter of the pressing collar and that the adaptor matches the pressing collar.
- 2 To open the pressing collar, pull the two shells apart.
- 3 Fit the pressing collar around the pressfitting and make sure that the pressing contour of the pressing collar is correctly positioned on the fitting bead.
- 4 Turn the pressing collar into the pressing position.

76.1 and 88.9 mm collars

- 1 Ensure the diameter of the pressfitting matches the diameter of the pressing collar and that the adaptor matches the pressing collar.
- 2 To open the pressing collar, depress the locking pin and at the same time, pull the pressing collar apart at the locking lug.
- 3 With pressing collar \varnothing 76.1 - 88.9 mm: The pressing collar is correctly positioned when the centring plate is pointing towards the pipe. Place the pressing collar around the pressfitting and ensure that the pressing contour of the pressing collar is seated on.

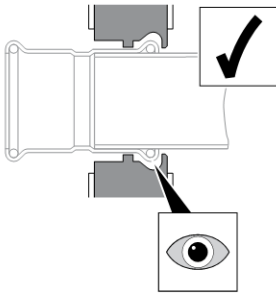

- 4 Slide the locking lug over the locking pin until it snaps into place and the pressing collar firmly surrounds the fitting.
- 5 Turn the pressing collar into the pressing position.

Hooking the adaptor for pressing collar into the pressing collar (up to \varnothing 88.9 mm)

Prerequisites

Pressing collar is positioned.

! WARNING
Risk of injury caused by flying fragments if used incorrectly or if worn or damaged adaptor jaws are used

- ▶ Make sure that the claws of the adaptor jaw always completely embrace the pins of the pressing collar.
- ▶ Clean away any dirt, chips or the like between the adaptor jaw and the pressing collar.

i Adaptor jaws are wearing parts. Frequent pressing will cause the material to become worn; advanced stages of wear will be indicated by cracks in the material. Adaptor jaws that display this kind of wear or are damaged in any other way may break, particularly if they are used incorrectly (e.g. pressing a fitting that is too large, tilting, etc.) or in a way that does not comply with their intended use.

- 1 To open the adaptor for pressing collar, press the jaw levers together (1).
- 2 Guide the claws of the adaptor as far as they will go into the grooves of the pressing collar (2) and hook them on the pins. Make sure that the claws completely embrace the pins (3).

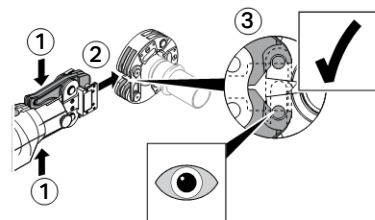

- 3 Release both jaw levers.

Pressing the connection (up to \varnothing 88.9 mm)

CAUTION
Risk of injury caused by flying fragments if used incorrectly or if worn or damaged pressing collars and adaptor jaws are used

▶ If the pressing collar and adaptor jaw have been used incorrectly, do not continue to use them and have them inspected by an authorized repair shop.

- 1 Press the pressfitting (see operating instructions for the pressing tool).
- 2 After the pressing sequence has been completed, make sure that the pressing collar is completely closed.
- 3 Open the adaptor jaw and remove it from the pressing collar.
- 4 Open the pressing collar and remove it.

CAUTION
Leaking connection due to failed pressing sequence

- ▶ Make sure that the pressing collar is completely closed after the pressing sequence.
- ▶ Have any pressing collars that have not been closed completely, as well as the adaptor jaw and pressing tool, inspected for damage by an authorized repair shop.
- ▶ Replace any connections that have not been pressed correctly and do not attempt corrective pressing.
- ▶ If there are any burrs on the pressfitting after the pressing sequence, have the pressing collar inspected by an authorized repair shop.

- 5 If correctly pressed, it will be possible to peel away the pressing indicator foil off the pressfitting.

Pressing pressfitting \varnothing 108 mm

The pressing sequence consists of two steps:

- Preliminary pressing with adaptor for pressing collar ZB 321
- Final pressing with adaptor for pressing collar ZB 322

The position of the locking pin in the locking lug indicates the status of the pressing sequence:

- Position 1: Pressing collar is positioned
- Position 2: After preliminary pressing with adaptor for pressing collar ZB 321
- Position 3: After final pressing with adaptor for pressing collar ZB 322

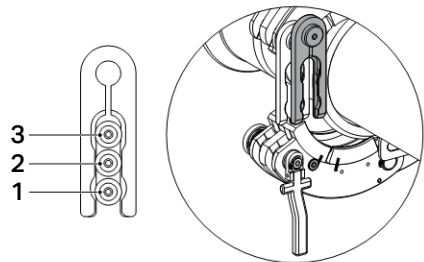

i The \varnothing 108 mm collar cannot be removed until the second press with the ZB 322 adaptor has been completed. If the correct position is not reached after the pressing operation, the pressing must be repeated. See also operating instructions of pressing tool ECO 301.

Fitting the pressing collar around the pressfitting (ø 108 mm)

CAUTION Leaking connection due to failed pressing sequence

- ▶ Clean away any dirt, chips or the like between the pressing collar and the pressfitting.
- ▶ Make sure the pressing collar is positioned correctly on the fitting bead.

CAUTION Damage to pipe due to faulty pressing collar that can no longer be released

- ▶ Make sure the sliding segments can move and give.
- ▶ Make sure that the sliding segments and shells can be aligned with one another.
- ▶ Replace the pressing collar if the sliding segments and shells are not functioning.

- 1 Ensure the diameter of the pressfitting matches the diameter of the pressing collar and that the adaptor for pressing collar matches the pressing collar.
- 2 To open the pressing collar, depress the locking pin and, at the same time, pull the pressing collar apart at the locking lug.
- 3 Ensure that the sliding segments move freely and that the marks (1) on the sliding segments (2) and the shells (3) form a line.

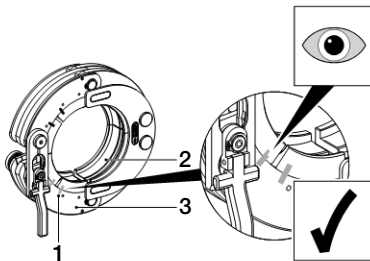

i The pressing collar is correctly positioned when the centring plate is pointing towards the pipe.

- 4 Fit the pressing collar around the pressfitting and ensure that the pressing contour of the pressing collar is positioned on the fitting bead.

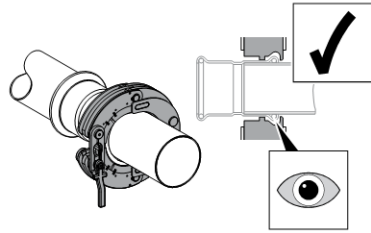

- 5 Slide the locking lug over the locking pin until it snaps into place (position 1) and the pressing collar firmly surrounds the fitting.
- 6 Turn the pressing collar into the pressing position.
- 7 Make sure the release lever and locking lug form a line.

Hooking the adaptor for pressing collar ZB 321 into the pressing collar (ø 108 mm)

Prerequisites

Pressing collar is positioned. Locking pin is in position 1.

WARNING Risk of injury caused by flying fragments if adaptor for pressing collar is used incorrectly

- ▶ Make sure that the claws of the adaptor for pressing collar always completely embrace the pins of the pressing collar.

i Repeat the pressing operation if a position of the locking pin is not reached during the pressing operation or the pressing sequence is interrupted. See also operating instructions of the pressing tool.

- 1 To open the adaptor for pressing collar, press the jaw levers together.

- 2 Guide the claws of the adaptor as far as they will go into the grooves of the pressing collar and hook them on to the locking pins. Make sure that the claws completely embrace the pins.

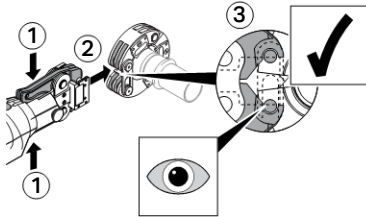

- 3 Release both jaw levers.

Preliminary pressing with adaptor for pressing collar ZB 321 (ø 108 mm)

- 1 Press the pressfitting; see operating instructions for pressing tool.
- 2 Open the adaptor for pressing collar and remove it from the pressing collar.
- 3 Make sure that the locking pin is in position 2.

i Result: Preliminary pressing is complete. The pressing collar can no longer be removed. The process of establishing the connection is not completed until the final pressing has been carried out with adaptor for pressing collar ZB 322.

Hooking the adaptor for pressing collar ZB 322 into the pressing collar (ø 108 mm)

Prerequisites

Pressing collar is positioned. Locking pin is in position 2.

! **WARNING**
Risk of injury caused by flying fragments if adaptor for pressing collar is used incorrectly

- ▶ Make sure that the claws of the adaptor for pressing collar always completely embrace the pins of the pressing collar.

i Repeat the pressing operation if a position of the locking pin is not reached during the pressing operation or the pressing sequence is interrupted. See also operating instructions of the pressing tool.

- 1 To open the adaptor for pressing collar, press the jaw levers together.
- 2 Guide the claws of the adaptor as far as they will go into the grooves of the pressing collar and hook them on to the locking pins. Make sure that the claws completely embrace the pins.

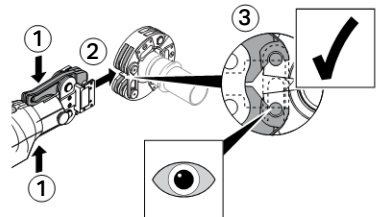

- 3 Release both jaw levers.

Final pressing with adaptor for pressing collar ZB 322 (ø 108 mm)

Prerequisites

Pressing collar is positioned. Locking pin is in position 2.

! CAUTION Risk of injury caused by pressing collar failing when released

- ▶ Hold pressing collar when releasing.

- 1 Press the pressfitting; see operating instructions for pressing tool.
- 2 Open the adaptor for pressing collar and remove it from the pressing collar.
- 3 Make sure that the locking pin is in position 3.

i Result: The final pressing completes the pressing sequence.

- 4 Pull the release lever towards the pressing collar. The locking pin is released and is located in position 1. The pressing collar is loosened.

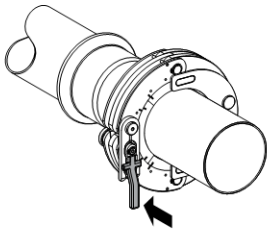

- 5 Press in the locking pin (1), pull the pressing collar apart and remove it (2).

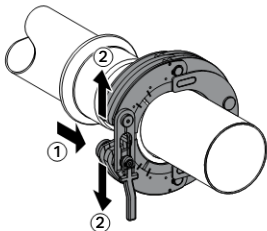

- 6 Check the pressed joint.

! CAUTION Leaky connection due to failed pressing sequence

- ▶ Ensure that the pressing collar is completely closed after the pressing sequence.
- ▶ Have any pressing collars that have not closed completely as well as the adaptor for pressing collar and the pressing tool inspected for damage by an authorised tool service agent. Replace any connections that have not been pressed correctly (do not attempt corrective pressing).
- ▶ If there are any burrs on the pressfitting after the pressing sequence, have the pressing collar and the adaptor for pressing collar inspected by an authorised tool service agent.

- 7 If correctly pressed, it will be possible to peel away the pressing indicator foil off the fitting.

Maintenance schedule (collars and adaptors)

An inspection sticker on the pressing collar and adaptor indicates the date when the next calibration is due. For information about Geberit Mapress tool service agents, please contact your responsible Geberit sales representative.

Table 73: Maintenance interval

Interval	Maintenance work
After 25 pressing operations	<ul style="list-style-type: none"> • Spray the pressing contour of the pressing collar with a small amount of BRUNOX® Turbo-Spray® or an equivalent lubricant
Regularly, before use at the start of the day	<ul style="list-style-type: none"> • Check the pressing collar and adaptor jaw for externally visible defects; in particular, damage, material cracks and other signs of wear. If defects are present, do not continue to use the pressing collar and/or adaptor jaw; either replace it/them or have the defects repaired by an authorized repair agent • Spray the pressing contour with BRUNOX® Turbo-Spray® or an equivalent lubricant, leave on for a short period and then remove dirt and deposits with a cloth • Spray the joints and the gap between the sliding segments and shells with BRUNOX® Turbo-Spray® or an equivalent lubricant and manipulate them until they are able to move easily. Wipe off any excess lubricant • Spray the complete pressing collar and adaptor jaw with a small amount of BRUNOX® Turbo-Spray® or an equivalent lubricant • Check that the jaw levers of the adaptor jaw can move easily. If necessary, spray the jaw joints with a small amount of BRUNOX® Turbo-Spray® or an equivalent lubricant • Clean the electrical contacts of the ZB 303 adaptor jaw
Every year (76.1 - 108 mm) or after 3,000 pressing operations or two years at the latest (35 - 66.7 mm and adaptor) - see service sticker on tool for latest date	<ul style="list-style-type: none"> • Have an authorised service agent check and re-calibrate the tool

1.6 Installation

1.6.1 Geberit Mapress press connection

Making a Geberit Mapress press connection

A Geberit Mapress press connection is made as follows:

- Prepare the pipe and fitting for the pressing operation
- Push pipe into fitting to correct insertion depth
- Optional: With \varnothing 54 - 108 mm fit the mounting device MH 1
- Press the fitting

CAUTION Risk of corrosion

- ▶ Keep cutting tools and deburring tools free from carbon steel chips when cutting Geberit Mapress Stainless Steel.
- ▶ Do not use high-speed cutting wheels to cut the pipe and fittings to length.
- ▶ Only use cutting tools that are suitable for working with steel.

CAUTION Leaking press connection can be caused by damaged seal ring

- ▶ Deburr the outside and inside of the pipe ends completely.
- ▶ Remove foreign bodies from the seal ring.
- ▶ Do not tilt the pipe into the pressfitting.
- ▶ Push the pressfitting onto the pipe, turning the pipe slightly.
- ▶ Only use lubricants which are free from oil and grease.

Prepare the pipe and fitting for the pressing operation

- 1 Check that the pipe and fitting are clean, undamaged and free from scoring or dents.
- 2 Determine the pipe length.
- 3 Cut the pipe to the correct length.

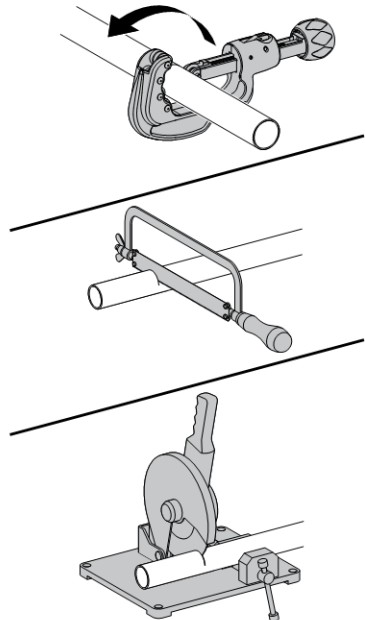

- i** Only shorten the fittings with plain ends up to the maximum permissible shortening dimension k , indicated in the product guide.

- 4 Deburr the pipe ends, internally and externally.

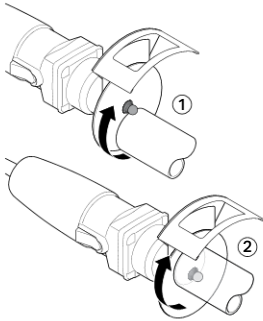
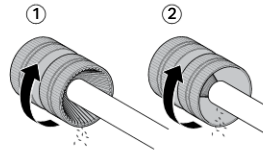

- 5 The plastic jacket of Geberit Mapress Carbon Steel must be stripped.

- i** If other tools than Geberit Mapress Carbon Steel stripping tools are used, the plastic jacket must be stripped to the insertion distance E.

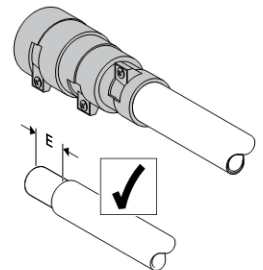
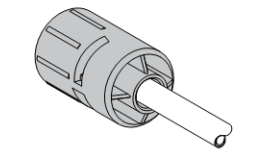

- 6 Clean chips from the pipe ends.

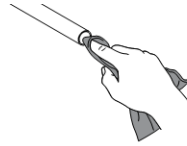

- 7 Mark the insertion distance.

- i** Insufficient mechanical strength if correct insertion depth is not observed.

- 8

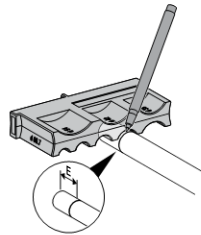

- 9 On fittings with a plain end, mark the insertion distance on the end.

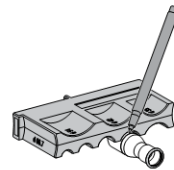

- 10 Remove the plug from the fitting.

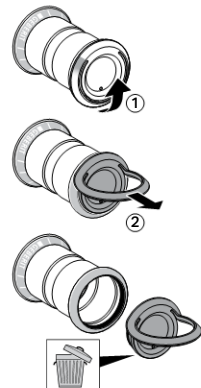

11 Check the seal ring.

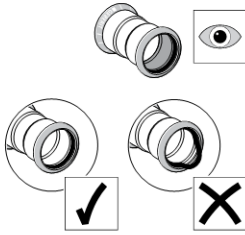

12 Push the fitting onto the pipe up to the marked insertion distance.

i The fitting can be pushed in more easily if oil and grease-free lubricant is applied or the fitting is immersed in water or soapy water.

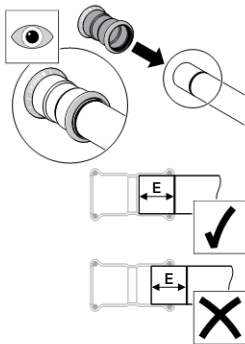

13 Align the pipe.

Make the connection with the threaded fitting

- 1 Fix the pipe in position.
- 2 Seal in the threaded connection.
- 3 Insert the threaded fitting and screw into place, counterholding the threaded fitting.

CAUTION
Leaking connection due to stress corrosion cracking

- ▶ Do not use Teflon for sealing.

Optional: with \varnothing 54 - 108 mm fit the mounting aid MH 1

i The installation dimensions are given in the operating instructions of the mounting aid.

- ▶ Clamp the pipes with the jaws of the mounting aid.

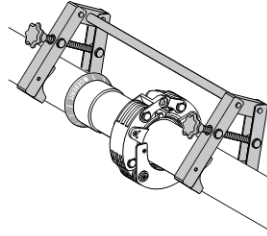

Press the fitting

Prerequisites

- The pipe or pre-assembled elements are aligned
- Threaded joints must be sealed in

- 1 Ensure that the diameter of the pressfitting matches the diameter of the pressing jaw or pressing collar:
 \varnothing 12 - 35 mm use pressing jaw,
 \varnothing 42 - 108 mm use pressing collar and adaptor.
- 2 Press the fitting.

- 3** \varnothing 108 mm pressfittings must be pressed twice, firstly using the ZB 321 and secondly the ZB 322 adaptor before the collar is removed.

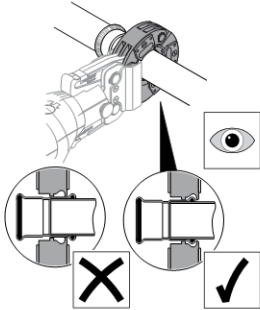
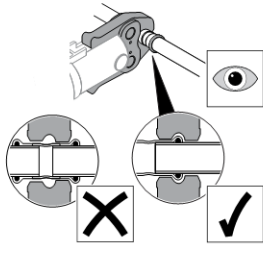

- 4** Remove pressing indicator from the fitting.

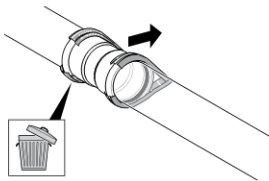

- 5** Check correct insertion depth has been made.

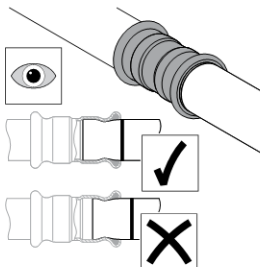

1.6.2 Geberit Mapress Carbon Steel, plastic coated, corrosion protection

Mount the corrosion protection sleeve

- 1** Clean the pipe and fitting from dirt and moisture.
- 2** Now apply a coat of primer to the fitting and plastic jacket of the pipe over a length of 20 mm.

i The primer does not have any resistance against corrosion. This is only used as a wash primer for the corrosion protection sleeve.

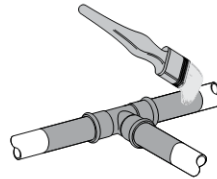

- 3** Let the primer dry.
- 4** Mount the corrosion protection sleeve.

i When applying the corrosion protection sleeve, make sure that there is an overlap of at least 15 mm and that the prepared part of the plastic jacket is included.

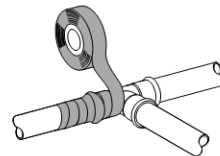

Result

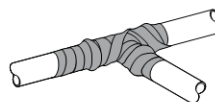

1.6.3 Minimum distances and space requirements

Minimum distances between two pressed joints

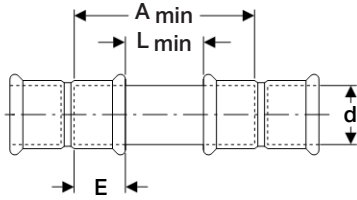

Table 74: Minimum distances between two pressed joints

d x s [mm]	A _{min} [cm]	L _{min} [cm]	E [cm]
12	1.0	4.4	1.7
15	1.0	5.0	2.0
18	1.0	5.0	2.0
22	1.0	5.2	2.1
28	1.0	5.6	2.3
35	1.0	6.2	2.6
42	2.0	8.0	3.0
54	2.0	9.0	3.5
76.1	2.0 ¹⁾ / 3.0 ²⁾	12.6 ¹⁾ / 13.6 ²⁾	5.3
88.9	2.0 ¹⁾ / 3.0 ²⁾	14.0 ¹⁾ / 15.0 ²⁾	6.0
108	2.0 ¹⁾ / 3.0 ²⁾	17.0 ¹⁾ / 18.0 ²⁾	7.5

¹⁾ Dimension applies to pressing with a Geberit ECO 301 pressing tool

²⁾ Dimension applies to pressing with a Geberit HCPS pressing tool

Pipe depths in wall and ceiling feed-throughs

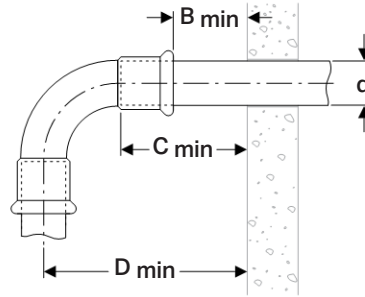
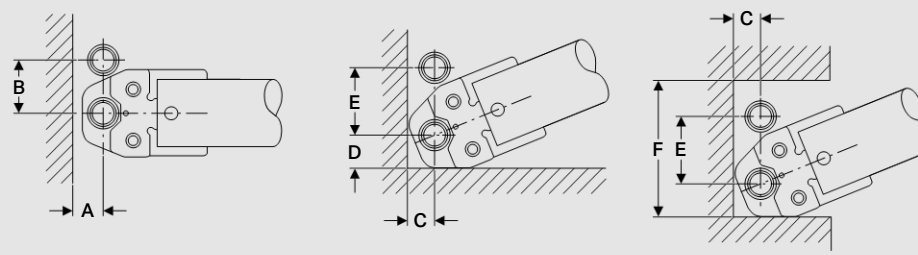

Table 75: Pipe depths in wall and ceiling feed-throughs

d x s [mm]	B _{min} [cm]	C _{min} [cm]	D _{min} [cm]
12	3.5	5.2	7.7
15	3.5	5.5	8.5
18	3.5	5.5	8.9
22	3.5	5.6	9.5
28	3.5	5.8	10.7
35	3.5	6.1	12.1
42	3.5	6.5	14.7
54	3.5	7.0	17.4
76.1	7.5	12.8	22.3
88.9	7.5	13.5	24.9
108	7.5	15.0	29.2

Space requirements when pressing with pressing tools

Table 76: Space requirements when pressing with pressing jaws for mounting on a smooth wall, in corners and in ducts



d [mm]	A [cm]	B [cm]	C [cm]	D [cm]	E [cm]	F [cm]
12 - 15	2.0	5.6	2.0	2.8	7.5	13.1
18	2.0	6.0	2.5	2.8	7.5	13.1
22	2.5	6.5	3.1	3.5	8.0	15.0
28	2.5	7.5	3.1	3.5	8.0	15.0
35	3.0	7.5	3.1	4.4	8.0	17.0

Table 77: Space requirements when pressing with pressing collars for mounting on a smooth wall, in corners and in ducts

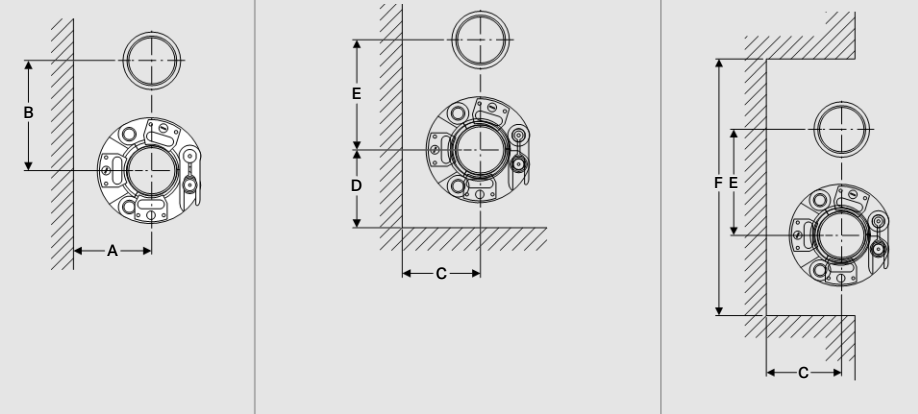

d [mm]	A [cm]	B [cm]	C [cm]	D [cm]	E [cm]	F [cm]
42	7.5	11.5	7.5	7.5	11.5	26.5
54	8.5	12.0	8.5	8.5	12.0	29.0
76.1	11.0	14.0	11.0	11.0	14.0	35.0
88.9	12.0	15.0	12.0	12.0	15.0	39.0
108	14.0	17.0	14.0	14.0	17.0	45.0

Table 78: Space requirements when pressing with a Geberit HCPS pressing tool with complete pre-mounting and single installation of the individual system pipe sections

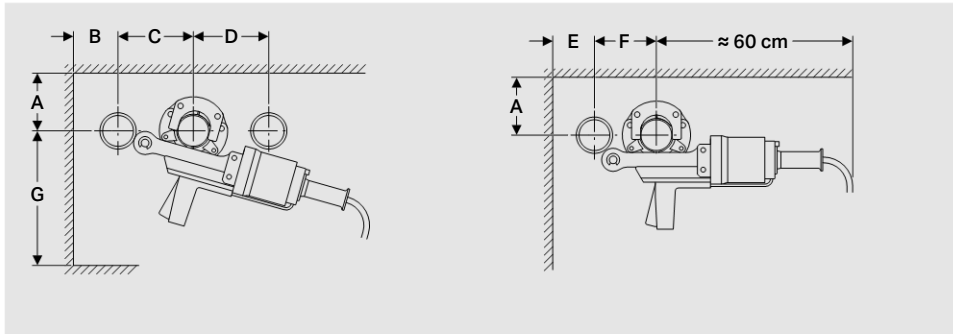

d [mm]	A [cm]	B [cm]	C [cm]	D [cm]	E [cm]	F [cm]	G [cm]
76.1	11.0	20.0	22.0	22.0	16.0	16.0	30.0
88.9	12.0	20.0	22.0	22.0	16.0	18.0	32.0
108	13.0	20.0	23.0	23.0	16.0	20.0	34.0

1.7 Corrosion

1.7.1 Corrosion Geberit Mappress Stainless Steel (1.4401)

Resistance to corrosion

Resistance to inner corrosion

Potable water

Corrosion-resistant steels do not react with potable water due to their protective chromium oxide layer. This means that Geberit Mappress Stainless Steel is resistant to corrosion upon contact with potable water and ensures a high level of potable water quality.

Local corrosion effects such as pitting or crevice corrosion can only occur with potable water or water which is similar to potable water with unduly high chloride content. Unduly high chloride contents occur if too much disinfectant containing chlorine is added when disinfecting potable water pipes. Therefore, the specifications for the duration of application and concentration for use must be strictly observed.

The content of water-soluble chloride ions in potable water and water which is similar to potable water should not exceed 250 mg/l.

Treated water

All water treatment methods such as, for example, ion exchange or reverse osmosis can be used with Geberit Mappress Stainless Steel. No additional measures to protect against corrosion are necessary.

Geberit Mappress Stainless Steel is resistant to corrosion with treated water such as:

- Softened/decarbonised water
- Fully desalinated water (deionised, demineralised, distilled and pure condensates)
- Ultrapure water with a conductivity of < 0.1 $\mu\text{S}/\text{cm}$

Resistance against external corrosion

Geberit Mappress Stainless Steel is resistant to corrosion due to the atmosphere (ambient air). The probability of corrosion is increased by contact with corrosion-promoting construction materials or by installation in corrosive atmospheres.

Resistance against bimetallic corrosion

The corrosion behaviour of Geberit Mapress Stainless Steel is not influenced by the direction of flow of the water through mixed installations (no-flow rule). In potable water installations, Geberit Mapress Stainless Steel can thus be combined with all non-ferrous heavy metals (gunmetal, copper, brass).

If Geberit Mapress Stainless Steel is directly connected to zinc-plated steel pipes, bimetallic corrosion will occur on the zinc-plated steel pipes. This can be prevented by taking the following measures:

- Installation of distance pieces of non-ferrous heavy metal (length $L > 50$ mm surface in contact with water)
- Installation of a shut-off valve made of non-ferrous heavy metals.

Colouring caused by deposits of other corrosive products does not indicate any risk of corrosion.

Corrosion protection

Protection against external corrosion

In areas at risk of corrosion, installation of pipes without corrosion protection should be avoided.

If there is the risk of corrosive substances (e. g. plaster, building materials containing chloride, concrete, nitrite or ammonium) acting on the pipes over prolonged periods, surface-mounting or suitable corrosion protection is recommended.

Protection against external corrosion must meet the following requirements:

- Waterproof
- Non-porous
- Resistant to heat and ageing
- Undamaged

The use of closed-cell insulation materials or hoses has proved to be effective as corrosion protection.

The minimum protection against external corrosion is coating, priming or painting.

Hoses or felt wrapping is not permissible, as felt retains absorbed moisture for prolonged periods and therefore promotes corrosion.



Planners and fitters are responsible for planning and implementing corrosion protection.

Gas installation

Geberit Mapress Stainless Steel Gas does not need any protection against corrosion due to the material properties of the steel. This also applies to concealed routing and underfloor routing, providing the following situations can be reliably excluded:

- Indirect or direct contact with materials or substances containing chloride or other corrosion promoters
- Indirect or direct contact with electrical current

Sufficient additional corrosion protection is required if these situations cannot be reliably excluded.

Influence of operational conditions and processing

Pitting corrosion after water pressure test

The probability of pitting corrosion is increased if residual water remains in the pipe after the water pressure test. Avoid partial filling of the piping system.

Electrical trace heaters

Electrical trace heaters can be used.

To prevent unacceptable increases in pressure caused by heating, blocked pipe sections must not be heated.

Bending Geberit Mapress Stainless Steel system pipes

Heating of the Geberit Mapress Stainless Steel pipes changes the material structure and increases the probability of intercrystalline corrosion. Geberit Mapress Stainless Steel system pipes should therefore never be bent when warm.

i Geberit Mapress Stainless Steel system pipes can be bent cold on building sites with standard pulling bending tools up to a diameter of \varnothing 54 mm.

Influence of sealing and insulating materials

Incorrectly used insulation materials can cause corrosion of pipes. Insulation materials for thermal insulation of pipes made of non-rusting steel may contain up to 0.05 % water-soluble chloride ions.

Sealing tape and materials of Teflon which contain water-soluble chloride ions are not suitable for sealing stainless steel threaded connections, as they can cause crevice corrosion in potable water pipes.

i Insulation materials and hoses of AS quality according to AGI-Q 135 are considerably below this level of maximum 0.05 % of water soluble chloride ions and are therefore particularly suitable for stainless steel.

Closed-cell insulating materials ensure effective corrosion protection, as they prevent the concentration of chlorides.

Suitable sealing materials are:

- Hemp sealing
- Plastic sealing tape and threads

Solder / welding of stainless steel pipelines

We do not recommend solder joints with stainless steel pipelines for aqueous media due to the type of danger caused by knife-cut corrosion.

We do not recommend that stainless steel pipelines in potable water installations are welded on the construction site using inert gas shielded arc welding. Even professional WIG / inert gas shielded arc welding cannot prevent annealing colours (oxide layers) resulting in the area of the weld seam.

Potable water supply lines made of stainless steel should only be installed on construction sites using pressed joints due to possible damage caused by corrosion resulting from soldering or welding.

1.7.2 Corrosion Geberit Mapress Carbon Steel

Corrosion of heating and other closed circuit installations

Resistance to internal corrosion

Geberit Mapress Carbon Steel is corrosion-resistant in heating systems and other closed circuits.

The probability of corrosion is increased if oxygen is present in the circuit.

Corrosion-causing oxygen can enter the circuit through compression glands, screw connections or automatic air vent valves if there is negative pressure in the heating system.

There is no risk of corrosive damage from oxygen that enters when filling and supplementing with water since the amount of oxygen is very low.

Concentrations of oxygen greater than 0.1 g/m^3 indicate an increased probability of corrosion.

i Geberit Mapress Carbon Steel is not corrosion-resistant in respect to the condensate drain of oil condensing boilers. The condensation in these systems has a pH value of 2.5 - 3.5 and can also contain sulphuric acid.

Resistance to external corrosion

Normally the outer surfaces of a pipe installation in a building do not come into contact with watery corrosive media. Therefore, with Geberit Mapress Carbon Steel, external corrosion can only occur after being exposed to unintended corrosive media over longer periods (e.g. penetration of rainfall, moisture in the walls, condensation, leaking, spray or cleaning water).

Geberit Mapress Carbon Steel should never be installed in permanently damp rooms.

- **Geberit Mapress Carbon Steel system pipe, outside zinc-plated and Geberit Mapress Carbon Steel fittings:** The 8 µm thick zinc coating meets the requirements of stress stage 1 in accordance with DIN EN ISO 2081. For this reason, the pipes and fittings are suitable for installation in warm and dry atmospheres. The zinc coating provides protection against the short term effect of moisture if the pipe surface can dry quickly.
- **Geberit Mapress Carbon Steel system pipe, plastic coated:** The plastic coating that is fitted onto the carbon steel system pipes from the factory provides good protection against external corrosion. Additionally the jointing parts must be protected against external corrosion.
- **Geberit Mapress Carbon Steel system pipe, inside and outside zinc-plated:** Geberit Mapress Carbon Steel system pipes, inside and outside zinc-plated, are made from hot-dip galvanized band. The zinc coating is approximately 20 µm thick and meets the requirements of stress stage 2 in accordance with DIN EN ISO 2081. This makes the pipes suitable for installation in rooms where condensation is allowed to occur.

Resistance against bimetal corrosion

In closed circuit waters, Geberit Mapress Carbon Steel can be combined with all product materials in any sequence.

Protection against internal corrosion

The following measures delay the generation of corrosion:

- Adding oxygen binding media to the circulating water
- Setting the pH value of 8.5 - 9.5 necessary for carbon steel
- Only use water additives that have been tested and approved by Geberit
- Observe the manufacturers' instructions for use



There is no danger of corrosion from oxygen that enters when filling and supplementing with water, as the oxygen is bound into iron oxide compounds as a result of the reaction with the inner steel surface of the system. In addition, the oxygen that is generated from the heated heating circuit water escapes when the heating system is de-aerated.

Protection against external corrosion

Geberit Mapress Carbon Steel should not be permanently exposed to moisture. In the case of installations in rooms with excessive exposure to moisture, the pipes should be installed outside of this area.

When installing in-wall or under screed, the Geberit Mapress Carbon Steel pressfittings and stripped sections of the pipe should be coated using an additional suitable corrosion protection.

Protection against outside corrosion is provided by:

- Coatings
- Plastic binders
- Corrosion protection binders

Protection against external corrosion must meet the following requirements:

- Waterproof
- Non-porous
- Resistant to heat and aging
- Undamaged

Thermal insulation material or hoses have been proven successful as a minimum protection against outside corrosion.

Thermal insulation materials are not an adequate corrosion protection with cooling water installations.

Felt or similar materials should not be used for corrosion protection, as felt retains absorbed moisture for prolonged periods and therefore promotes corrosion.

 Planners and fitters are responsible for planning and implementing corrosion protection.

Corrosion of compressed air installation

Geberit Mapress Carbon Steel is only resistant against corrosion in dehumidified compressed air systems with dry compressed air. Any humidity and air contained in the installation system may lead to corrosion.

If the compressed air contains lubricating oil over 5 mg/m³, then the blue FKM seal ring must be used.

1.7.3 Corrosion Geberit Mapress Copper

Resistance to external corrosion

Geberit Mapress Copper is resistant to corrosion from the atmosphere (ambient air).

The probability of corrosion is increased by contact with corrosion-promoting construction materials or by installation in corrosive atmospheres. In such situations, suitable corrosion protection measures should be implemented.

Resistance against bimetal corrosion

Geberit Mapress Copper can be combined with all materials in any sequence for the following installations:

- Closed-circuit water heating systems
- Water circuits without risk of internal corrosion

In these cases Geberit Mapress Copper can be combined with Geberit Mapress Stainless Steel or Geberit Mapress Carbon Steel.

If Geberit Mapress Copper is combined with zinc-plated steel pipes in drinking water installations or open water systems, the flow rule must be observed due to the different voltage potentials of these materials.

 Flow rule: Copper must always be installed downstream from components made of zinc-plated steel.

Protection against external corrosion

Protection against external corrosion must meet the following requirements:

- Waterproof
- Non-porous
- Resistant to heat and aging
- Undamaged

Protection against external corrosion is ensured, for example, by:

- Coatings
- Plastic binders
- Corrosion protection sleeves

Hoses of felt wrapping is not permissible as felt retains absorbed moisture for prolonged periods and therefore promotes corrosion.

 Planners and fitters are responsible for planning and implementing corrosion protection.

Resistance to internal corrosion

Corrosion in potable water installations

Geberit Mapress Copper is resistant to corrosion when used for potable water installations if the potable water meets the following chemical parameters:

- pH value > 7.4 or
- $7.4 > \text{pH value} > 7.0$ and $\text{TOC} < 1.5 \text{ g/m}^3$

Note: TOC total organic carbon content in the water

For reasons of corrosion protection the salt content is limited by the Drinking Water Directive as follows:

- Sulphate ions < 240 mg/l
- Nitrate ions < 50 mg/l
- Sodium ions < 200 mg/l

Corrosion heating installations

Geberit Mapress Copper is resistant to corrosion in open and closed water heating and cooling systems.

1.7.4 Corrosion Geberit MapressCuNiFe

Resistance to corrosion

Geberit Mapress system pipes made of CuNi10Fe1.6Mn have an excellent corrosion resistance, especially against sea water. The reason for the good corrosion resistance is a natural thin protective layer that develops quickly under the influence of clean water.

This complicated protective layer mainly comprises copper(I) oxide and is improved using additional nickel and iron. The final layer develops quickly, within the first few days, but requires up to three months before it is completely developed. The decisive factor for the long-term behaviour of copper / nickel is the initial effect (exposition), which means that the pipes must be continually rinsed through using clean sea water. When a good surface layer has developed, the speed of the corrosion reduces over the years.

They are resistant against:

- Moisture
- Non-oxidising acids
- Alkalis
- Saline solutions
- Organic acids
- Dry gasses (oxygen, chlorine, hydrogen chloride, hydrogen fluoride, sulphur dioxide and carbon dioxide)

In principle, copper-nickel alloys with 10 % and with 30 % nickel (Ni) have a good resistance against sea water. This also applies to hot sea water and for medium flow speeds of up to 6 m/s.

When the flow speed for a given geometry has reached a size that is too large, the protective layer may become damaged due to the effect of shearing stress from the sea water, and this may lead to impact erosion. According to DIN EN 85004-2, the flow speed should be between 1 m/s and max. 3.0 m/s, depending on the diameter.

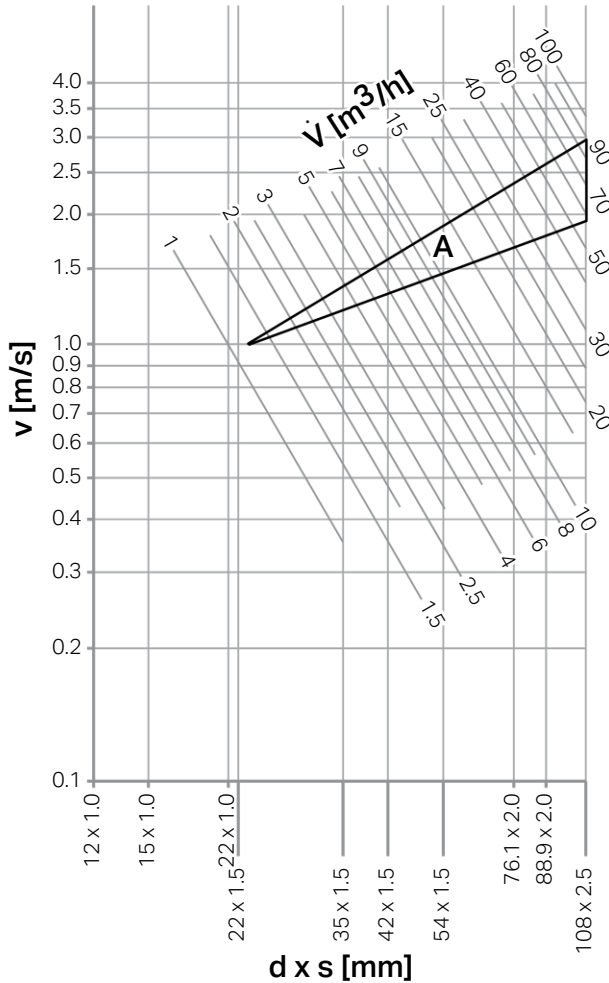

Figure 51: Flow speed Geberit MappressCuNiFe according to DIN EN 85004-2

- v Flow speed
 \dot{V} Volume flow
 $d \times s$ Outside diameter x Wall thickness
 A Recommended range for the flow speed

The proportion of iron in the copper-nickel alloy considerably improves the adhesive strength of the corrosion-protection layer and therefore the resistance against wearing corrosion, especially in sea water and other aggressive waters, such as briny water.

Resistant to internal corrosion

Copper-nickel alloy possesses a high resistance against chloride and crevice corrosion.

Intensive chlorination (dosage) can have a negative effect as the corrosion resistance is reduced through wear.

1.8 Fire prevention

The following Geberit piping systems are suitable for extinguishing water pipes:

- Geberit Mapress Stainless Steel
- Geberit Mapress Carbon Steel, inside and outside zinc-plated
- Geberit Mapress Copper
- Geberit MapressCuNiFe

1.8.1 Classification of extinguishing water pipes

Extinguishing water pipes are fixed installation pipes with lockable fire extinguishing hose connector devices (wall hydrants as self-help facilities as well as for use by the fire brigade).

Extinguishing water pipes are categorised as follows:

- "Wet" extinguishing water pipes: The riser pipe is wet and constantly filled with drinking water
- "Dry" extinguishing water pipes: The riser pipe is dry and if necessary, is filled and operated with non-drinking water by the fire brigade
- "Wet / dry" extinguishing water pipes: The riser pipe is dry and if necessary, is filled and operated with water from the drinking water network via remote actuation of taps

Extinguishing water pipes are part of the drinking water installation and require no additional approvals.

1.8.2 Fixed water extinguishing systems

Fixed water extinguishing systems are fixed fire extinguishing and fire prevention installations which independently detect and report a fire and automatically initiate the extinguishing procedures.

Fixed water extinguishing systems are subdivided into the following:

- Systems with open nozzles (e.g. spraying water extinguishing systems or tank irrigation systems)
- Systems with closed nozzles (such as sprinkler systems)

These systems are subject to the approval specifications of the VdS association.

1.8.3 Application range and operating conditions

The following table indicates which Geberit piping systems can be used for different types of extinguishing water pipes and the maximum operating pressure that must not be exceeded.

When planning the extinguishing water pipes, it must be ensured that no water hammers occur when opening and closing the valves since this would lead to the maximum operating pressure being exceeded.

Table 79: Application range and maximum operating pressure of Geberit piping systems for extinguishing water pipes

Extinguishing water pipe	Medium	Geberit Mapress Stainless Steel		Geberit Mapress Carbon Steel	Geberit Mapress Copper	Operating pressure _{max.} [bar]
		1.4401	1.4521	internally and externally zinc-plated		
Wet	Drinking water	x	x	-	x	16
	Non-potable water	x	x	x	x	
Wet / dry	Drinking water	x	x	-	x	
	Non-potable water	x	x	-	x	
Dry	Non-potable water	x	x	-	x	

1.8.4 Pressure test

In extinguishing water pipes "dry" and "wet / dry", the pressure test is performed using compressed air or inert gases.

1.9 Noise Insulation

Pipelines do not represent additional sources of noise.

However, they may transmit noises (solid-borne noise) that have other origins (appliances, taps) and must therefore be installed with sound insulation.

1.10 Additional work



The country-specific regulations and guidelines must be observed in the following description for additional work.

1.10.1 Pressure test

Completed pipes must be tested for tightness before they are covered or painted. They should be tested with a pressure test. The pressure test can be performed with water or air. The test medium depends on the installed and planned commissioning. If the pipe system is to be left empty after the pressure test, a pressure test with air or inert gas should be performed. The test medium and results should be documented in the test report.

The entire system must undergo a visual check prior to the pressure test. During this check, care should be taken to ensure that the pipelines have been installed professionally.

Pressure test for drinking water installations

Tightness test with air

The tightness test for drinking water installations with compressed air or inert gases is also described in the information sheet "Tightness test for drinking water installations with compressed air, inert gas or water" of the ZVSHK / BHKS. For safety reasons, the test pressures are set to a maximum value of 3 bar which also applies for gas pipes.

The tightness test must be performed as follows:

Criteria for pressure test using oil-free compressed air or inert gas

Leak test:

- Test pressure max. 150 hPa (mbar)
- Test time
 - Pipe volume \leq 100 litres, test time 120 minutes
 - Test time plus 20 minutes for each additional 100 litres of pipe volume
- No pressure drop during the entire test time

Load test:

- Test pressure
 - \leq DN max. 300 kPa (3 bar)
 - \geq DN 50 max. 100 kPa (1 bar)
- Test time 10 minutes
- No pressure drop during the entire test time

Criteria for pressure test with filtered water with „leaky if unpressed“ check

Leak test:

- Test pressure max. 300 kPa (3 bar)
- Test time 15 minutes
- No pressure drop during the entire test time

Load test:

- Test pressure 1.1x operating pressure min. 1100 kPa (11 bar)
- Test time 30 minutes
- No pressure drop during the entire test time

Pressure test with water

The tightness test with water is described in the ZVSHK / BHKS information sheet "Tightness test of drinking water installations with compressed air, inert gas or water".

The tightness test with water should be performed directly before commissioning for reasons of hygiene and chemical corrosion. If this is not possible, the system must remain completely filled until commissioning. If necessary, disinfectant must be added to the water (for additional information please refer to the ZVSHK / BHKS information sheet)



The medium for the pressure test with water must be of drinking water quality to prevent contamination of the pipe system.

If water remains in a pipe which contains air after a water pressure test, there is a higher risk of pitting corrosion, especially if the pipe system is not completely closed. This higher risk of corrosion results from evaporation of the remaining water which leads to an increase in the chloride ion content in the remaining liquid phase.

Pressure test for heating installations

The pressure test in installed pipes is generally performed with water (e. g. in accordance with DIN-VOB 18380)

The following must be observed during the pressure test on heating installations:

- The test pressure is 1.3 times the operating pressure at all points of the system, but at least 1 bar overpressure
- Immediately after the cold water pressure test, it should be checked that the system remains tight even at the highest temperature. For this purpose, the system must be heated to the calculated highest temperature.
- No pressure drop may occur during the test
- The pressure test must be adequately documented

Pressure test for natural gas installations

The pressure test for natural gas installations is performed, for example, according to DVGW G 600 / TRGI 86/96.

The type of pressure test depends on the operating pressure:

- Pipes with operating pressures of up to 0.1 bar must undergo a preliminary and main test.
- Pipes with operating pressures ranging from 0.1 to 1 bar must undergo a combined load and tightness test

Preliminary and main test

The preliminary test (tightness test) must be performed as follows:

- The test medium is either air or inert gas (e. g. nitrogen or carbon dioxide)
- The test pressure is 1 bar
- The test time is 10 mins., during the test the pressure should not drop
- The preliminary test must be adequately documented

The main test (tightness test) must be performed as follows:

- The test medium is either air or inert gas (e. g. nitrogen or carbon dioxide)
- The test pressure is 110 mbar
- The test time is 10 mins. after temperature compensation has been completed
- The main test must be adequately documented

Combined load test and tightness test

The combined load test and tightness test must be performed as follows:

- The test medium is either air or inert gas (e. g. nitrogen or carbon dioxide)
- The test pressure is 3 bar
- The test time is at least 2 hours after completed temperature compensation of 3 hours
- During the test time possible changes in temperature in the test medium must be observed
- A pressure recorder class 1 and a pressure gauge class 0.6 must be used.
- The pressure test must be adequately documented

Pressure test for liquid gas installations

The pressure test for liquid gas installations is performed, for example, in accordance with TRF 1996.

The requirements of the pressure test apply for low and medium pressure pipes.

The pressure test can be performed with air or nitrogen and also with water.

The pressure test with air or nitrogen must be performed as follows:

- The test pressure is 1.1 times the permissible operating overpressure, but at least 1 bar,
- The minimum test time is 10 mins. after temperature compensation has been completed
- The pressure test must be performed together with the corresponding equipment
- The pressure test must be adequately documented

The pressure test with water must be performed as follows:

- The pressure test with water must be performed at 1.3 times the permissible operating overpressure
- If a pressure test is planned for initial or periodical tests, corresponding discharge connections should be provided when the pipe is installed, or the layout should be designed for bottom discharge
- The pressure test must be correspondingly documented

1.10.2 Flushing pipes

The pipes are flushed before commissioning with drinking water or an intermittent mixture of compressed air and water.

More information on flushing drinking water pipes is given in DIN EN 806-4 and the information sheets of the ZVSHK / BHKS.



The medium for flushing the pipes must be of drinking water quality to prevent contamination of the pipe system.

1.10.3 Insulation

General

The insulating of the pipelines serves to avoid:

- Heat loss
- Heating of the media to be transported through the surroundings and
- Propagation of sound

Drinking water installation

Drinking water pipelines (TW) must be protected against the formation of condensation and against heating. Drinking water pipelines that transport cold water should be installed at a sufficient distance from sources of heat so that the water quality is not affected by heating.

Pipelines for hot drinking water (TWW) and circulation pipes (TWZ) must be insulated against unallowable loss of heat due to energy saving measures and for hygienic reasons.

Heating installations

The insulating of water heating systems is an energy saving measure. This measure for environmental protection serves to reduce the discharge of CO₂. In the private area, energy consumption for heating is the largest individual item with 53 %.

Cooling water system

The main task of the cold insulation is to prevent condensation formation and reduce the loss of energy over the complete period of using the cold water pipelines. The safe and permanent prevention of higher energy costs and the dew point temperature can only be achieved by using the correct dimensioning.



Insulation materials / insulating hoses can trigger corrosion attacks on the pipelines. As a result, special care must be made to the suitability of the materials to be used, when selecting them.

1.10.4 Disinfection of Geberit piping systems

Principles

Drinking water installations must only be disinfected in proven cases of contamination for a limited time. Prophylactic disinfection contradicts the minimum quality requirements of the Drinking Water Ordinance.

Disinfection of drinking water installations is only successful when all sources of contamination have been removed.

The limit values for disinfectant concentration specified in the Drinking Water Ordinance are maximum values, which were set under hygienic and toxicological viewpoints. They do not allow any automatic conclusions to be drawn about the resistance of the product materials to disinfectants.

Drinking water installations may only be disinfected by skilled persons. The disinfection measures must be recorded in writing.



Disinfection measures carried out incorrectly can damage the drinking water installation.

Disinfection process

Drinking water pipes can be disinfected using thermal or chemical methods.

In the case of chemical disinfection, a distinction is made between the following:

- Status disinfection (high concentration for use, low temperatures, 24 hours maximum)
- Continuous disinfection for a limited period (low concentration for use, high temperatures)

A combined thermal chemical disinfection is not permitted.

Thermal disinfection

Geberit piping systems are thermally disinfected as follows:

- The water heater and the entire circulation must be heated up to at least 70 °C
- All points of use should be opened step by step or line by line respectively
- Hot water must be allowed to run at all points of use for at least three minutes at 70 °C
- The temperatures must not decrease during the disinfection process
- The maximum temperature of 95 °C must not be exceeded

- The risk of scalding must be eliminated by taking suitable measures
- The maximum disinfection duration is 150 hours per year

Chemical disinfection



Chemical disinfectants corrode the drinking water installation and must, therefore, only be used in cases of contamination.

Using a combination of several chemical disinfectants is not permitted.

Status disinfection

Geberit piping systems are suitable for status disinfection. Active ingredients, concentrations, temperatures and residence times must be strictly observed in accordance with table 1. The following requirements must also be observed:

- Skilled persons must take specific measuring and control technology precautions
- Specific conditions of the affected drinking water installation must be taken into account to avoid increases in concentration
- Concentrations, temperatures and residence times should be documented in writing
- Complete a cleaning and disinfection report in accordance with DVGW W 291

The drinking water installation must be cleaned thoroughly after disinfection with hygienically perfect drinking water to remove the disinfectant and dead germs. All points of use must be flushed until the limit value of the Drinking Water Ordinance is reached.

Measures should be taken to ensure that no drinking water is consumed during the disinfection process and the subsequent cleaning phase.

Continuous disinfection

Geberit piping systems are suitable for continuous disinfection, although this is only possible for a limited period. Active ingredients, concentrations and temperatures must be strictly observed in accordance with table 80. The following requirements must also be observed:

- Skilled persons must take specific measuring and control technology precautions
- Specific conditions of the affected drinking water installation must be taken into account

to avoid increases in concentration

- Concentrations, temperatures and byproducts must be monitored and documented directly behind the dosing point using measurement technology
- Measure the concentration of the agent in the treated water on a daily basis

Due to the minimisation requirement ("Minimierungsgebot") of the Drinking Water Ordinance, continuous disinfection should be kept as short as possible. It should last no longer than it takes for technical modernisation to be completed.

Disinfectants

Table 80: Disinfectants for status disinfection of Geberit piping systems in accordance with DVGW W 291

Description	Trading form	Storage	Safety notes ¹⁾	Concentration for use ²⁾ Duration of application ²⁾ Application temperature ²⁾
Hydrogen peroxide H ₂ O ₂	Aqueous solution in various concentrations	<ul style="list-style-type: none"> • Not exposed to light • Cool • Avoid contamination at all costs 	Protective equipment is required for solutions > 5 %	<ul style="list-style-type: none"> • 150 mg/l H₂O₂ • Max. 24 hours • Max. 25 °C
Sodium hypochlorite NaOCl	Aqueous solution with max. 150 g/l chlorine	<ul style="list-style-type: none"> • Not exposed to light • Cool • Sealed in a collection tray 	<ul style="list-style-type: none"> • Alkaline • Corrosive • Toxic • Protective equipment required 	<ul style="list-style-type: none"> • 50 mg/l chlorine • Max. 24 hours • Max. 25 °C
Calcium hypochlorite Ca(OCl) ₂	Granulate or tablets approx. 70 % Ca(OCl)	<ul style="list-style-type: none"> • Cool • Dry • Sealed 	<ul style="list-style-type: none"> • Alkaline • Corrosive • Toxic • Protective equipment required 	<ul style="list-style-type: none"> • 50 mg/l chlorine • Max. 24 hours • Max. 25 °C
Chlorine dioxide ClO ₂	Two components (sodium chloride, sodium peroxodisulphate)	<ul style="list-style-type: none"> • Not exposed to light • Cool • Sealed 	<ul style="list-style-type: none"> • Oxidising • Do not inhale chlorine dioxide gas • Protective equipment required 	<ul style="list-style-type: none"> • 6 mg/l ClO₂ • Max. 24 hours • Max. 25 °C

¹⁾ Observe the corresponding instructions in the manufacturer's material safety data sheets.

²⁾ Values approved by Geberit. During use, the concentration for use and temperature must not be exceeded at any point of the piping system.

Table 81: Disinfectants for continuous disinfection of Geberit piping systems for a limited period in accordance with §11 Drinking Water Ordinance 2001

Substance name	Max. permissible dosage for treatment ¹⁾	Max. concentration for use ²⁾	Max. application temperature ³⁾	Reaction products to be observed
Calcium hypochlorite	1.2 mg/l free Cl ₂	0.3 mg/l free Cl ₂	60 °C	Trihalomethane (THM), bromate
Sodium hypochlorite	1.2 mg/l free Cl ₂	0.3 mg/l free Cl ₂	60 °C	Trihalomethane (THM), bromate
Chlorine dioxide	0.4 mg/l ClO ₂	0.2 mg/l ClO ₂	60 °C	Chlorite
Ozone	10 mg/l O ₃	0.05 mg/l O ₃	60 °C	Trihalomethane (THM), bromate

¹⁾ Concentration at any point in the drinking water installation

²⁾ Maximum concentration for use at end of treatment (concentration at point of use; water with this concentration is deemed to be drinking water)

³⁾ Different temperature specifications apply in the case of thermal disinfection and status disinfection

1.10.5 Descaling

Limescale deposits on Geberit Mapress Stainless Steel with the butyl rubber seal ring (CIIR) can be removed if necessary with limescale removers which have been approved by Geberit.

Geberit is unable to make any statements on the effectiveness of the limescale remover.

When using the limescale remover the following must be observed:

- Limescale removers must be checked to ensure that they are compatible with the seal ring CIIR black. Approval can be obtained from Geberit
- Always observe the manufacturer's instructions for use

Table 82: Geberit Mapress Stainless Steel limescale remover

Limescale remover	Chemical formula	Concentration	Temperature for use [°C]	Remarks
Sulfamic acid	H ₂ NSO ₃ H	5 - 10 % aqueous solution	25	Manufacturer: Hoechst
Citric acid	HO C CH ₂ CO ₂ H ₂ CO ₂	25 % diluted	20	For slight deposits For short-term use

1.10.6 Equipotential bonding

Metallic gas and water supply pipelines must be integrated into the equipotential bonding of the building. Equipotential bonding must be provided for all electrically conductive pipelines.

 The person installing the electrical system is responsible for the equipotential bonding.

The following pipelines are electrically conductive and must be integrated into the equipotential bonding:

- Geberit Mapress Stainless Steel
- Geberit Mapress Stainless Steel Gas
- Geberit Mapress Carbon Steel, zinc-plated on the outside
- Geberit Mapress Carbon Steel, inside and outside zinc-plated
- Geberit Mapress Copper
- Geberit MapressCuNiFe

Piping systems with Geberit Mapress Carbon Steel system pipes, plastic coated, are not electrically conductive and do not have to be integrated into the main equipotential bonding. Therefore they are not suitable for the additional equipotential bonding.

1.10.7 Operation of the pipe installations

All applicable regulations must be observed for commissioning of pipe installations.

The system installer must brief the owner or manager on the installation. This must be documented by a handover and acceptance report.

The system owner or manager must also be given the maintenance and operating instructions for the installed taps and appliances.

The owner or manager of pipe installations is obliged to keep the system in correct working order.

Pipe installations must be run so that malfunctions and manipulation of the operational safety of the system is excluded.

The system owner is advised to conclude a maintenance contract with the installation company.

2 Application technology

2.1 Building applications

Geberit Mapress is suitable for the following applications:

Table 83: Geberit Mapress building applications

Medium	Seal Ring	Geberit Mapress Stainless Steel 1.4401	Geberit Mapress Stainless Steel Gas	Geberit Mapress Carbon Steel	Geberit Mapress Copper	Geberit Mapress Copper Gas	Max. pressure [bar]	Temp [°C]	Comments
Well water	CIIR black	X			X		16	0 - 100	
Potable water	CIIR black	X			X		16	0 - 100	
Purified water	CIIR black	X			X		16	0 - 100	
Factory water	CIIR black	X			X		16	0 - 100	
Ground water	CIIR black	X			X		16	0 - 100	
Surface water	CIIR black	X			X		16	0 - 100	
Treated water	CIIR black	X					16	0 - 100	Not for pharmaceutical grade waters
Heating water	CIIR black	X		X	X		16	0 - 120	
Condensate from gas condensing boilers	CIIR black	X					16	Max. 120	
Condensate from steam units	CIIR black	X			X		16	Max. 120	
Water-anti-freeze mixture	CIIR black	X		X	X		16	-30 - 120	For approved anti-freezes
Water-anti-freeze mixture	FKM blue	X		X	X		16	-25 - 180	For approved anti-freezes
Argon	CIIR black	X		X	X		16	Room temp	

2 Application technology

Medium	Seal Ring	Geberit Mapress Stainless Steel 1.4401	Geberit Mapress Stainless Steel Gas	Geberit Mapress Carbon Steel	Geberit Mapress Copper	Geberit Mapress Copper Gas	Max. pressure [bar]	Temp [°C]	Comments
Compressed air	CIIR black	X		X	X		16	Room temp	Residual oil content max. 5 mg/m ³ . Not for medicinal gases
Compressed air	FKM blue	X		X	X		16	Room temp	Not for medicinal gases
Carbon dioxide	CIIR black	X		X	X		16	Room temp	Not for medicinal gases. Not for dry ice
Nitrogen	CIIR black	X		X	X		16	Room temp	Not for medicinal gases
Vacuum	CIIR black	X (sili- cone free)		X	X		0.2 absolute	Room temp	Absolute 0.2 corresponds to -0.8 bar in the installation
Methanol	CIIR black	X			X		16	Room temp	
Ethanol	CIIR black	X			X		16	Room temp	
Propanol	CIIR black	X			X		16	Room temp	
Heating Oil EL	FKM blue	X		X	X		5	-20 - 70	
Engine and Transmission Oil	FKM blue	X		X	X		5	-20 - 70	
Natural Gas	HNBR yellow		X			X	5	-20 - 70	Only in the gas phase. Observe all standards, regulations and norms. No underground installation.
LPG	HNBR yellow		X			X	5	-20 - 70	
Methane	HNBR yellow		X			X	5	-20 - 70	
Ethane	HNBR yellow		X			X	5	-20 - 70	
Propane	HNBR yellow		X			X	5	-20 - 70	
Butane	HNBR yellow				X		16	-20 - 70	

 The country-specific regulations and guidelines must be observed in the following description for building applications.

2.1.1 Drinking water installation

Types and quality

The drinking water installation includes:

- Cold water pipes [TW]
- Hot water pipes [TWW] (85 °C conforming to DIN EN 806)
- Circulation pipes [TWZ]
- Extinguishing water pipes [TW] conforming to DIN 1988-600 and DIN 14462 for the applications wet, dry / wet and dry

The quality of drinking water must meet the stipulations of the European Drinking Water Ordinance of DIN EN 806 on the quality of water for human consumption and the Drinking Water Ordinance (DWO).

In Germany, in addition, the DIN EN 12502 for material selection and the national standard DIN 50930-6 "Influencing water quality" also apply. The materials are selected on the basis of a new drinking water analysis in compliance with DIN EN 12502 and DIN 50930-6.

Pipe layout

General

The drinking water is distributed to the draw-off points on the various floors. The floor pipes branch from the riser pipes.

Distribution behind floor taps is possible with:

- Conventional T-piece installation
- Floor manifold¹

Various versions of the pipe arrangement can be routed to the draw-off points. The constantly increasing demands regarding optimum hygiene and corrosion resistance as well as thermal and acoustic insulation require a technically sound pipe layout design by the planner and fitter. The pipes are either routed over the unfinished floor of the intermediate floors or inside pre-wall elements.

Conventional T-piece installation is replaced by joint-free, fully flexible pipes in one pipe dimension. The selection of a correct pipe arrangement ensures excellent drinking water distribution without stagnation in the intermediate floor manifold. In addition, the technical actions for minimising the growth of Legionella bacteria are provided.

Specifications for intermediate floor and individual supply pipes without circulation with a water volume of < 3 litre are generally fully met by one pipe dimension. Due to the low water content, the water is swiftly replaced after stagnation phases.

The following must be taken into account when planning pipe arrangements:

- Pipe arrangement
- Pipe laying
 - Type of prewall installation
 - Concealed installation in conventional masonry slits
- Location, type and number of the water draw-off points
- Type of use or frequency of water draw-off

When planning the pipe arrangement, all technical rules, standards and regulations must be taken into account. In addition, the following points must be complied with:

- Available pressure for the pipe should be used as far as possible
- The flow rates should be kept high
- Continuous flow through the entire pipe layout
- On draw-off points which are not used often, for reasons of hygiene (swift water replacement after stagnation phase) the pipe layout should be circular

For economical pipe layouts in intermediate floor installations individual pipes, series-connected pipes, circular pipes or a combination of these should be selected.

Pipe layouts such as T-piece installations or individual supply lines should only be selected for hygienic reasons if water is daily drawn off from the connected draw-off points.

¹ The Mepla lined metal pipe in rolls is very suitable to this purpose due to its flexibility.

The most economical and best hygiene conditions are series-connected and circular pipes. In comparison to all other pipe layouts the circular pipe systems have advantages due to high flow rates with the same pressure and heat distribution.

In addition, higher water draw-off is possible with the circular pipes and with small pipe diameters. The planner can select the most suitable version of the following illustrated and described pipe layouts.

Conventional T-piece installation

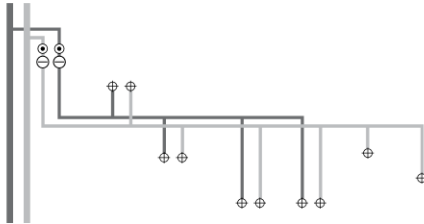

Figure 52: Conventional system

Advantages of conventional T-piece installation:

- Prefabrication of the complete unit or sections
- Efficient installation

Disadvantages of conventional T-piece installation:

- Possibly greater stagnation phases
- Draw-off points must be used regularly
- Greater pressure loss than in individual supply pipe systems

Individual supply pipe system

With the individual supply pipe system each draw-off point is connected to a separate supply pipe from the intermediate floor manifold.

This installation method is selected if there are only short pipe lengths between the manifold and the draw-off points, there is only a low pipe pressure and the draw-off points cannot be combined in groups with series connection or circular pipes.

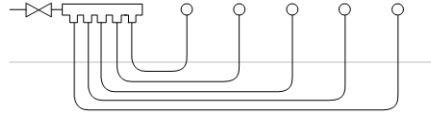

Figure 53: Individual supply pipe system

Advantages of the individual supply pipe system:

- Small pipe cross-sections
- Low water content
- Minimised pressure losses
- Individual connection for higher water requirements
- Less planning and calculation work
- Quick and easy pipe installation

Disadvantages of the individual supply pipe system:

- Greater stagnation phases
- Draw-off points must be used regularly
- Greater space requirements for pipes and intermediate floor manifold

Series-connected pipe system

The pipe layout is routed from one draw-off point directly to the next with double connections. Draw-off points are combined in groups and several draw-off points supplied by a joint pipe.

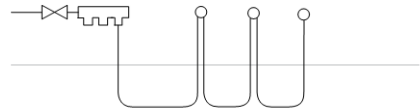

Figure 54: Series-connected pipe system

Advantages of the series-connected pipe system:

- Simple pipe layout
- Less pipe requirements
- Quick installation
- Low space requirements for intermediate floor manifold
- Low stagnation volume due to fast water replacement
- Optimum hygiene if a draw-off point which is frequently used is at the end of the row

Disadvantages of the series-connected pipe system:

- Higher pressure loss
- Larger draw-off point at beginning of row if possible

Circular pipe system

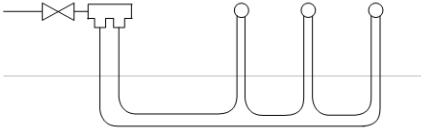

Figure 55: Circular pipe system

Advantages of the circular pipe system:

- Lower pressure loss enables higher water draw-off and considerably more draw-off points with the same size pipe cross-section
- More favourable pressure losses:
 - Approx. 30 % in comparison to series-connected pipes
 - Approx. 50 % in comparison to conventional T-piece installation
- Various draw-off points can be connected at greater distances from the intermediate floor manifolds or riser pipes
- Less space requirements for intermediate floor manifolds, as only two connections depending on the number of draw-off points
- Regular pressure and heat distribution
- Optimum water replacement
- Low stagnation times, replacement of the water content when one draw-off point is used
- The best pipe layout from an hygienic view-point, even with draw-off points which are not often used

Combined circular pipe system

The combined circular pipe system is suitable for pipe layouts with high water draw-off.

Individual draw-off fittings with a flow of $\dot{V}_R = 0.4 \text{ l/s}$ can each be connected with a circular pipe.

Advantages of the combined circular pipe system:

- At low supply pressures efficient hydraulic water supply

- Approx. 30 % lower pressure losses in comparison with individual supply pipes

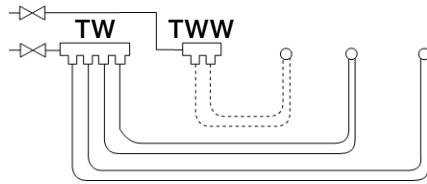

Figure 56: Combined circular pipe system

TW Cold drinking water

TWW Hot drinking water

Combined pipe system

The individual supply pipe system, series-connected supply pipe system and circular pipe system can be combined.

Installation example of a high-standard apartment:

- Individual WC supply line
- Series-connected double washbasin
- Kitchen: Circular pipe with dishwasher and washing machine
- Circular pipe for shower and bathtub with high water requirements

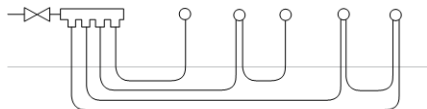

Figure 57: Combined pipe system

Advantages of the combined pipe system:

- Pipe layout can be adapted to the respective requirements
- High water requirements are met, even at draw-off points with high requirements, with small pipe diameter
- Low pressure losses with regular pressure and heat distribution
- Low degree of stagnation
- Optimum water replacement at draw-off points which are not often used

Combined pipe system

The pipe layout is a combination of individual supply pipe and circular pipe with a T-piece connection to the draw-off points.

The draw-off points can be connected in variable pipe layouts.

- Individual WC supply line
- Larger water draw-off points as circular pipe

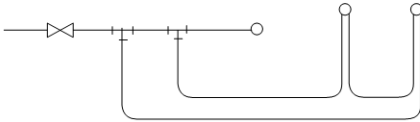

Figure 58: Combined pipe system

Block pipe system

Combinable sanitary connections (groups, blocks) such as shower and bathtub, WC, bidet or double sink branch as several series-connected connections from a joint intermediate floor manifold. The connections are either single or double connections.

Advantages of the block pipe system:

- Shorter pipe lengths
- Low space requirements for intermediate floor manifold

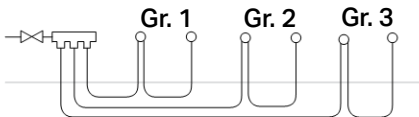

Figure 59: Block pipe system

Gr. Group

Group high-standard pipe system

In this pipe layout the cold water pipe is a circular pipe. The hot water is routed from the hot water intermediate floor manifold through to the last draw-off point of the individual group as a series-connected pipe and then back as a circulation pipe to the intermediate floor circulation collector.

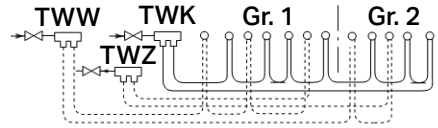

Figure 60: Group high-standard pipe system

- TWK Cold drinking water
- TWW Hot drinking water
- TWZ Drinking water circulation
- Gr. Group

Advantages of the high-standard group pipe system:

- No stagnation, optimum water replacement and optimum water distribution (cold water pipe as a circular pipe)
- All hot water draw-off points as series-connected pipe with circulation
- Operation prevents growth of Legionella bacteria
- Regular hot water temperature distribution with circulation collector

Disadvantages of the high-standard group pipe system:

- High space requirements for intermediate floor manifold or collector

Drinking water hygiene

Drinking water is our most valuable resource. It cannot be replaced.¹

The planner, installer and owner of a drinking water installation are responsible for ensuring drinking water hygiene in the system. Planning, installation and operation of a system must comply with specific standards and codes of practice in accordance with hygienic considerations.

¹ DIN 2001, section 2.1

Planning

When planning drinking water installations, the following points must be taken into account:

- Use of certified/approved installation materials (DVGW approval mark)
- Planning of large projects is based on the building description and use of the individual rooms, preventing over-dimensioning and stagnation (bypass pipes/dead pipes are not permitted)
- Insulation of hot and cold water
 - Cold water < 20 °C
 - Hot water > 55 °C
 - Mixture of cold/hot water only directly before the draw-off point
- System planning should take into account that during subsequent operation it should be possible to clean and disinfect appliance and system elements (accessible pipe inspection sections / sampling valves)
- Planning of fire extinguishing pipes in accordance with DIN 1988-600 and the DVGW data sheet W405



Hot drinking water systems must be planned in accordance with DVGW W 551 and W 553. The size of the drinking water heater should be as small as possible.

Installation

When drinking water systems are installed, general and operative requirements must be taken into account:

General requirements:

- Processing of the installation systems in accordance with manufacturer's specifications
- Avoidance of combined installations with products of different manufacturers
- Hand-out of the pipe layout documentation to the owner

Operative requirements:

- Storage of pipes/fittings in a dry and clean place
- Prevention of internal soiling on pipes and fittings
- Only remove films, caps etc. immediately before installation
- Do not lubricate or moisten sealing rings
- Protect installed system components against soiling (replace clean film or caps)

Commissioning

Commissioning must be performed in accordance with the following ZVSHK-information sheets:

- Tightness test on drinking water installations with compressed air, inert gas or water
- Flushing, disinfection and commissioning of drinking water installations

Operation

General instructions for operation:

- Always run drinking water installations in accordance with the applicable technical standards (cold water temperature < 20 °C and hot water temperature > 55 °C at each draw-off point)
- Prevent stagnation by suitable consumption
- Disconnect pipes which are no longer in use (DIN EN 1717)
- Do not use water from garden hoses as drinking water

Interruptions in operation:

- In the event of absence of, for example, a period of more than three days, the drinking water supply should be shut off before the water meter in buildings with one household and by the intermediate floor shut-off tap in blocks of flats (DIN EN 806-5).
- When the system is taken into operation again once more after interruption, the taps should all be opened fully for a short period (for example 5 minutes) (DIN EN 806-5).

Maintenance and repair:

- Coarse filters, hot water storage tank and heater should be regularly inspected and cleaned
- Keep shower heads, flow regulators and inserts on taps clean and remove deposits
- In large buildings a repair or hygiene plan should be compiled in accordance with VDI 6023 with the documentation of pipe system data



The plumber must instruct the owner on use of the system and remind the owner that he is obliged to have the system serviced regularly.

Geberit Mapress pressfitting systems

The following Geberit Mapress pressfitting systems can be used for drinking water installations:

- Geberit Mapress Stainless Steel 1.4401

Geberit Mapress Stainless Steel 1.4401 can be used for all types of drinking water without restriction.

The applications comprise:

- Cold water pipes [TW]
- Hot water pipes [TWW] (85 °C conforming to DIN EN 806)
- Circulation pipes [TWZ]
- Extinguishing water pipes [TW] conforming to DIN 1988-600 and DIN 14462 for the applications wet, dry / wet and dry

Hygiene characteristics

The high level of drinking water quality is not affected by the Geberit Mapress Stainless Steel 1.4401.

Geberit Mapress Stainless Steel 1.4401 does not release any heavy metals to the drinking water and cannot cause nickel allergies. The permitted limit value for a nickel migration is significantly fallen below (in accordance with EU Directive 98: < 0.02 mg/l Nickel).

The approvals and hygiene tests for the pressed joints also include the gap between the pressfitting and the seal ring CIIR black made of butyl rubber.

The seal ring complies with the recommendations for plastics in drinking water systems (KTW recommendations) and has passed the test for hygiene according to the national DVGW data sheet W 270.

For extinguishing water pipes, Geberit Mapress Stainless Steel 1.4401 corresponds to the requirements of DIN 1988-600.

Chlorine content in drinking water

Geberit Mapress Stainless Steel 1.4401 is also suitable for drinking water when chlorine is continually added for disinfection.

According to the Drinking Water Ordinance, a maximum of 1.2 mg/l chlorine (free chlorine in the disinfection solution) can be added. The limit value of free chlorine is allowed to be 0.3 mg/l in treated drinking water.

Exceptions are approved with a high or increased degree of microbial contamination up to 6 mg/l chlorine (free chlorine in the disinfection solution). The content of free chlorine in the drinking water is only allowed to rise to a maximum of 0.6 mg/l in this case.

Drinking water installation

Geberit Mapress Stainless Steel 1.4401 is suitable for all approved drinking water after treatment and does not require any additional measures for protection against corrosion.

Treated water

Geberit Mapress Stainless Steel 1.4401 with the black seal ring CIIR made of butyl rubber is suitable for all types of treated water such as partially desalinated (descaled, decarbonised) and fully desalinated (deionised, demineralised and distilled) up to highest-grade water with a conductivity less than 0.1 µS/cm and is absolutely corrosion-resistant.

All water treatment methods such as ion exchange or reverse osmosis etc. can be used.

Geberit Mapress Stainless Steel 1.4401 is not suitable for highest-grade water, pharmaceutical water or similar that has increased purity requirements exceeding the drinking water quality

Electrical trace heaters

Electrical trace heaters can be used if it is ensured that the temperature of the inside wall of the pipe does not exceed 60 °C over prolonged periods.

2.1.2 Gas installation

Geberit Mapress pressfitting systems

The following Geberit Mapress pressfitting systems can be used for gas installations:

- Geberit Mapress Stainless Steel Gas (natural gas and liquefied gas)
- Geberit Mapress Copper Gas (natural gas and liquefied gas)
- Geberit Mapress Stainless Steel Silicone Free (technical gases)

Geberit Mapress Stainless Steel Gas and Geberit Mapress Copper Gas have been checked and certified for gas installations according to the requirements of the following testing guidelines:

- DVGW VP 614
- ÖVGW G1 TR Gas (A)

Geberit Mapress Stainless Steel Gas and Geberit Mapress Copper Gas are approved and certified for the following media:

- Natural gases
- Liquefied gases

Table 84: Application range of Geberit piping systems for natural gas and liquefied gas

Medium		Geberit Mapress Stainless Steel silicone free	Geberit Mapress Stainless Steel Gas	Geberit Mapress Copper Gas	Seal ring	Remarks
Natural gas	-	-	X	X	HNBR yellow	No underground installation
Methane	CH ₄	-	X	X	HNBR yellow	No underground installation
Ethane	C ₂ H ₆	-	X	X	HNBR yellow	No underground installation
Ethene (ethylene)	C ₂ H ₄	-	X	X	HNBR yellow	No underground installation
Propane	C ₃ H ₈	-	X	X	HNBR yellow	No underground installation
n-butane	C ₄ H ₁₀	-	X	X	HNBR yellow	No underground installation
Biogases	-	-	X	X	HNBR yellow	No landfill gases No underground installation

Note

Geberit Mapress Stainless Steel system pipe 1.4401 should always be used with Geberit Mapress Stainless Steel Gas pressfittings in gas supply installations.

The pressfittings are factory pre-mounted with a yellow seal ring HNBR made of hydrogenated acrylonitrile-butadiene rubber. The marking is displayed in table 47, "Marking of Geberit Mapress Stainless Steel Gas pressfitting," on page 24.

Laying

Geberit Mapress Stainless Steel Gas is HTB approved ($p_{HTB,max} = 5 \text{ bar}$) and can be laid on the wall as well as concealed in the wall.¹

Geberit Mapress Stainless Steel Gas is installed as an above ground pipeline within buildings (with HTB) and outside buildings (without HTB). There is no approval for installations underground.

An additional protection against corrosion with concealed installations is not necessary due to stainless steels outstanding resistance against corrosion.

The properties of the copper mean that additional corrosion protection may be necessary when laying under plaster and building materials containing gypsum, ammonia or nitrite. Connections to commercially available gas fittings and components made from gunmetal, brass, die cast aluminium as well as ductile grey cast iron are made using pressfittings with thread or flange connections.

In case of repairs, the connection to the system pipe made of stainless steel or copper is established through material-specific adapter components of Geberit Mapress Stainless Steel Gas or Geberit Mapress Copper Gas pressfittings, or through commercially available adapters (such as GEBO adapter with union nut for gas) according to DIN EN or DVGW.

Such off-system adapters must be implemented with the utmost care. Special care must be taken to ensure that the outer surface of the system pipe is correctly prepared and not damaged.

1 HTB: High Thermal Loads (proven tightness of the connection at 650 °C and PN 5 / PN 1 over a period of 30 min)

Table 85: Application range and operating conditions for Geberit piping systems for technical gases (including pure gases)

Medium	Chemical Symbol	Purity \geq	Geberit Mapress Stainless Steel silicone free	Geberit Mapress Stainless Steel Gas	Geberit Mapress Copper Gas	Seal ring	Operating pressure max. [bar]	Operating temperature [°C]
Acetylene	C ₂ H ₂	2.6	X	-	-	CIIR black	Depending on the type of gas and the pipe dimensions Please contact Geberit to obtain data	Ambient temperature
Ammonium	NH ₃	3.8	X	-	-	CIIR black		
Argon	Ar	6.0	X	-	-	CIIR black		
Nitrous oxide	N ₂ O	1.8	X	-	-	CIIR black		
Helium	He	6.0	X	-	-	CIIR black		
Carbon dioxide	CO ₂	4.5	X	-	-	CIIR black		
Carbon monoxide	CO	3.7	X	-	-	FKM blue		
Krypton	Kr	4.0	X	-	-	CIIR black		
Neon	Ne	4.0	X	-	-	CIIR black		
Propene (propylene)	C ₃ H ₆	2.5	X	-	-	FKM blue		
Oxygen	O ₂	4.5	X	-	-	CIIR black		
Sulphur dioxide	SO ₂	3.0	X	-	-	CIIR black		
Nitrogen	N ₂	6.0	X	-	-	CIIR black		
Hydrogen	H ₂	6.0	X	-	-	CIIR black		
Xenon	Xe	4.0	X	-	-	CIIR black		
Shielding gases BS EN 439	-	-	X	-	-	CIIR black		
Synthetic air	-	-	X	-	-	CIIR black		
Vacuum	-	-	X	-	-	CIIR black		

Other gases, purities and notes on possible applications or material compatibilities are available on request.

Unsuitable gases

Geberit piping systems must not be used for the following gases:

- Gases in accordance with the requirements of the European Pharmacopeia Gases approved as proprietary medicinal products in accordance with pharmaceutical regulations, e. g. anaesthetic gases, medical oxygen, medical carbonic acid.

The gas tightness of Geberit Mpress Stainless Steel was demonstrated in the helium leak test with a resulting leak rate $< 1 \times 10^{-5}$ mbar·l/s

2.1.3 Heating installations

Process of the heating systems

Heaters are systems that have the main purpose of regulating temperatures by heating cold rooms so that the people staying in the room feel comfortable. Most heating systems are closed loop systems that are filled with water for transferring the heat. The medium is heated by the heat generator and is brought into circulation using a circulation pump and the heat is released again at defined positions in the room through irradiation and / or convection.

Therefore a heating system consists of the following fundamental processes:

- Heat generation
- Heat distribution
- Heat dissipation

In **heat generation**, the provided energy is converted into useful heat by the heat generator.

In **heat distribution**, the useful heat is transferred from the heat generator to the individual heat discharge locations.

In **heat dissipation**, the useful heat is transferred to the heat discharge locations such as radiators, panel heaters or air heating equipment in the rooms to be heated.

The following illustration explains the principle processes in a heating system:

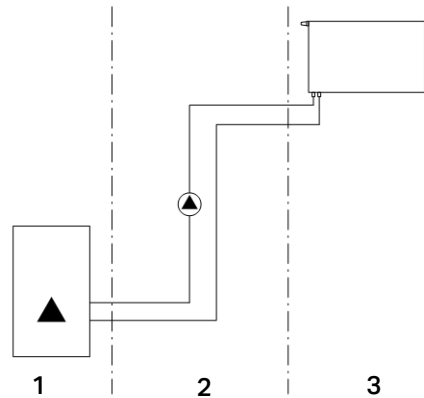

Figure 61: Fundamental processes of a heating system

- 1 Heat generation
- 2 Heat distribution
- 3 Heat dissipation

Classification of warm water heating systems

Warm water heating systems can be classified according to the following principles:

Principle	Types
Connection to the atmosphere	<ul style="list-style-type: none"> • Open heating systems • Closed heating systems
Acting turnover force	<ul style="list-style-type: none"> • Gravitation force heating systems • Pump heating systems
Channel of supply	<ul style="list-style-type: none"> • District heating supply • Local heating supply
Heat distribution	<ul style="list-style-type: none"> • One pipe heating systems • Two pipe heating systems
Pipe layout	<ul style="list-style-type: none"> • Upper distribution • Lower distribution

Open and closed heating systems

The following figures show the structure of an open and a closed heating system

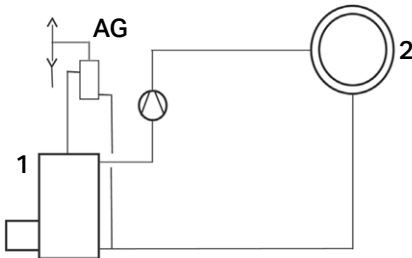

Figure 62: Open water heating system

- 1 Heating tank
- 2 Consumers
- AG Compensation vessel

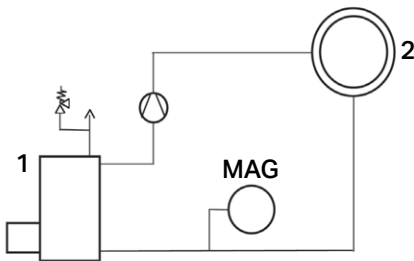

Figure 63: Closed water heating system

- 1 Heating tank
- 2 Consumers
- MAG Diaphragm compensation vessel

Geberit Mapress pressfitting systems

The following Geberit Mapress pressfitting systems can be used for heating installations:

- Geberit Mapress Stainless Steel
- Geberit Mapress Carbon Steel
- Geberit Mapress Copper

Geberit Mapress Stainless Steel and Geberit Mapress Copper

Geberit Mapress Stainless Steel and Geberit Mapress Copper can be used for all closed and open hot water heating systems that have a maximum operating temperature of 120 °C without restriction.

Geberit Mapress Carbon Steel

Geberit Mapress Carbon Steel can be used for all closed hot water heating systems that have a maximum inlet flow temperature (sustained temperature) of 120 °C. Prevent atmospheric oxygen from entering the heating water.

Geberit Mapress Carbon Steel is not suitable for open water heaters due to the thin wall thickness and the oxygenation capacity that is a feature of the system.

Additives in the heating water must be checked to ensure that they are compatible with the black seal ring CIIR/EDPM.

Table 86: Corrosion-protection agents, Geberit Mapress Stainless Steel, Geberit Mapress Copper and Geberit Mapress Carbon Steel

Agent	Seal ring / flat gasket			Test conditions		Manufacturer
	CIIR	EPDM ¹⁾	FKM	Concentration [%]	Temperature [°C]	
Castrol Zwipro III	X	X	X	100	20	Castrol
Hydrazine	X	X	-	For details of concentration for use, see manufacturer's specifications		Lanxess, Leverkusen
Levoxin 64	X	X	-	100	120	Lanxess, Leverkusen
Keboacor 213	X	-	X	0.5	20	Kebo Chemie, Düsseldorf
Sodium diethyldithiocarbamate	X	X	-	0.07	20	Various manufacturers
Sodium sulphite	X	X	-	For details of concentration for use, see manufacturer's specifications		Various manufacturers
P3-ferrolix 332	X	X	X	0.5	20	Henkel AG, Düsseldorf
ST-DOS K-375 ²⁾	X	-	X	0.5	20	Schweitzer Chemie, Freiberg/N.
Thermodus JTH-L	X	X	-	1	90	Judo, Waiblingen
Tri-sodium phosphate	X	X	-	For details of concentration for use, see manufacturer's specifications		Various manufacturers

¹⁾ Operating temperature of the EPDM flat gasket up to maximum 100 °C

²⁾ For sprinkler systems

X: Tested and approved; other concentrations or temperatures must be cleared with Geberit

-: Not tested or not approved; application must be cleared with Geberit

2.1.4 Remote and local heat installation

Principles

A remote heating network is a pipe which distributes heat (heating water) over a long distance from a central heat source to consumers.

Local heating networks have short distribution distances between the heat source and the consumers.

Remote and local heating pipes are sub-divided as follows:

- **Primary circuit:**
The primary circuit is the pipe layout from the heat source to the transition point (building inlet).
- **Secondary circuit:**
The pipe layout inside the building of the consumer (house network) is referred to as the secondary circuit.

Connection of the secondary circuits to the primary circuits in remote and local heating networks can be either direct or indirect.

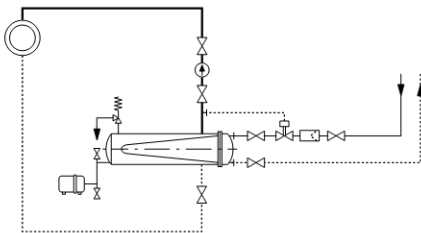

Figure 64: House station with indirect connection of the heating system to the remote heating network

Geberit Mapress pressfitting systems

The following Geberit Mapress pressfitting systems can be used for the secondary circuit of remote and local heat installations:

- Geberit Mapress Stainless Steel
- Geberit Mapress Carbon Steel

The following operational conditions apply:

Table 87: Operational conditions for Geberit Mapress Stainless Steel and Geberit Mapress Carbon Steel in remote and local heat installations

Geberit Mapress seal ring	Operating temperature _{max} [°C]	Remarks
CIIR black	120	Only in secondary circuit
FKM blue	140	-

2.1.5 Heat pump installation

Principles

The most important fuels for hot water heating and hot water provision are heating oil and gas. At the beginning of the seventies more attention was paid to looking for alternative energy sources which are available in sufficient quantities. For this reason, attempts were made to make use of the temperature of the air, water and ground. The energy of these sources is inexhaustible and can be easily regenerated by the radiation of the sun (also diffusely). The heat quantities of these sources are of relatively low temperatures, so that direct use for hot water heating or provision is not possible.

By means of the use of physical processes, these low temperatures are increased by so-called heat pumps and used for heating.

The heat pump uses the reverse of the principle of operation of a cooling system (e.g. refrigerator):

- As the result of vaporisation (expansion) of a refrigerant, the heat is removed from the energy source (air, water, ground)
- In the compressor the temperature level of the vaporised refrigerant is increased by compression
- The generated heat is transferred to the heating circuit in the condenser

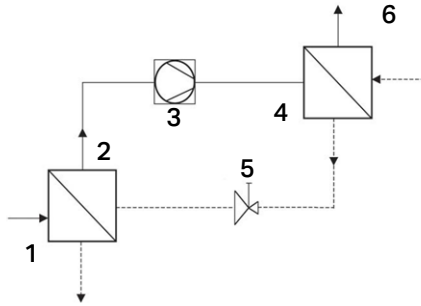

Figure 65: Principle of operation of a heat pump

- 1 Surroundings (air, water, ground)
- 2 Vaporiser
- 3 Compressor
- 4 Condenser
- 5 Expansion valve
- 6 Consumer circuit (heating, hot water)

In building technology there are the following main types of heat pumps:

- Air/water heat pump
- Water/water heat pump
- Brine/water heat pump

The heat quantities from the various sources is reflected in the performance number of the heat pump (quotient of heating performance and electrical power consumption).

The utilisable temperature levels require different modes of operation and control of the heat pump systems, e.g.:

- Monovalent operation
- Bivalent-parallel operation
- Bivalent-partially-parallel operation
- Bivalent-alternative operation

Geberit Mapress pressfitting systems

The following Geberit Mapress pressfitting systems can be used for installing heat pumps:

- Geberit Mapress Stainless Steel 1.4401
- Geberit Mapress Carbon Steel



Finished antifreeze agents based on glycol contain further additives. The compatibility of the seal rings with these water additives must be tested.

Geberit Mapress Stainless Steel 1.4401

Geberit Mapress Stainless Steel 1.4401 can be used for heat pump systems that have a maximum operating temperature of 120 °C.

Geberit Mapress Stainless Steel 1.4401 can be used to connect the ground connector or serve as a ground connector.

The installation of Geberit Mapress Stainless Steel 1.4401 system pipes as a heat exchanger coil with a cooling base for recovering the stored solar energy from the ground or air is also possible using heat collector fences or heat collector branches.

The following table provides an overview of the tested and approved corrosion-protection agents with corrosion protection.

Geberit Mapress Carbon Steel

Geberit Mapress Carbon Steel can be used for closed heat pump systems that have a maximum operating temperature of 120 °C.

Prevent atmospheric oxygen from entering the heating water.

The following table provides an overview of the tested and approved corrosion-protection agents with corrosion protection.

Table 88: Antifreeze agents with corrosion protection, Geberit Mapress Stainless Steel, Geberit Mapress Carbon Steel

Agent	Seal ring / flat gasket			Test conditions		Manufacturer
	CIIR	EPDM ¹⁾	FKM ²⁾	Concentration [%]	Temperature [°C]	
Kühlerschutz ANF	X	X	X	100	20	Eurolub, Eching (near Munich)
Antifreeze	X	-	-	100	60	Aral
Antifrogen N	X	X	X	100	120	Clariant
Antifrogen L	X	X	-	100	120	Clariant
Antifrogen SOL	-	-	X	100	120	Clariant
Glysantin G 30	X	X	-	67	120	BASF
Pekasol L	X	X	-	50	120	Prokühlsole, Alsdorf
	X	X	-	50	20	
Solarliquid L	X	X	X	50	130	Staub Chemie, Nuremberg
Tyfocor	-	-	X	40	130	Tyforop Chemie, Hamburg
Tyfoxit F20	-	-	X	100	130	Tyforop Chemie, Hamburg
Tyfocor L	-	-	X	40	170	Tyforop Chemie, Hamburg
Tyfocor LS	X	X	X	40	130	Tyforop Chemie, Hamburg

¹⁾ Operating temperature of the EPDM flat gasket up to maximum 100 °C

²⁾ Seal ring and flat gasket

X: Tested and approved; other concentrations or temperatures must be cleared with Geberit

-: Not tested or not approved; application must be cleared with Geberit

2.1.6 Cooling water installation

Principles

Cooling water installations serve on the one hand to create a pleasant climate in rooms for habitation and on the other hand to maintain the functional safety of machines and system components (motors, turbines).

For economical reasons, various types of water (ground water, surface water or brackish water) are used as a medium.

There are open-circuit and closed-circuit cooling water systems.

The difference in temperature between the inlet flow and the return flow should be as great as possible, so that a large quantity of heat is carried away with a small quantity of circulating water.

The cheapest temperature range of an air conditioning system for building technology purposes is 9 K.

The inlet temperature ranges from +4 °C to +6 °C, the return temperature from +12 °C to +15 °C. This range is always determined by the respective application.

Geberit Mapress pressfitting systems

The following Geberit Mapress pressfitting systems can be used in cooling water installations:

- Geberit Mapress Stainless Steel 1.4401
- Geberit Mapress Carbon Steel
- Geberit Mapress Copper

Cooling liquids in the pressing circuit must be checked with Geberit prior to use.

Geberit Mapress Stainless Steel 1.4401

Geberit Mapress Stainless Steel 1.4401 can be used for all open and closed cooling water systems without restriction under the following operating conditions:

- Geberit Mapress Seal ring CIIR black
 - Water/ antifreeze mixture: -30 - +40 °C
 - Cooling water: 0 - 100 °C

The content of water-soluble chloride ions in cooling water should not exceed 250 mg/l. see table 88 on page 111 provides an overview of the tested and approved antifreeze agents with corrosion protection.

Geberit Mapress Carbon Steel

Geberit Mapress Carbon Steel can be used for closed cooling water systems under the following operating conditions:

- Geberit Mapress Seal ring CIIR black
 - Water/ antifreeze mixture: -30 - +40 °C
 - Cooling water: 0 - 100 °C

The non-alloy steel is not suitable for open cooling water systems due to the thin wall thickness and the high oxygenation capacity, which would cause corrosion.

Table 88 on page 111 provides an overview of the tested and approved antifreeze agents with corrosion protection.

In cooling water systems, due to the high risk of condensation on the outside of the pipe, additional external corrosion protection must be provided.

Geberit Mapress Copper

Geberit Mapress Copper can be used for open and closed cooling water systems under the following operating conditions:

- Geberit Mapress Seal ring CIIR/EPDM black
 - Water/ antifreeze mixture: -30 - +40 °C
 - Cooling water: 0 - 100 °C

2.1.7 Solar installations

Principles

Solar heating systems are a special method for obtaining thermal energy by using solar energy.

The collector and absorber surface absorbs the solar energy (also diffusely). The absorbed thermal energy is routed to the heat storage tank by a solar liquid, normally a water and antifreeze mixture.

The main application is hot water heating; subsequent heating is performed with a heating boiler.

The use of solar energy for heating purposes is only possible to a limited degree, as during the winter months the energy level of the sun is relatively low.

If the solar system is used in combination with hot water heating and a heating system (combined system), the hot water heater is supplied first. When the hot water tank is heated, the excess thermal energy is made available for heating the rooms. This method of using solar energy can also be used for heating swimming pool water.

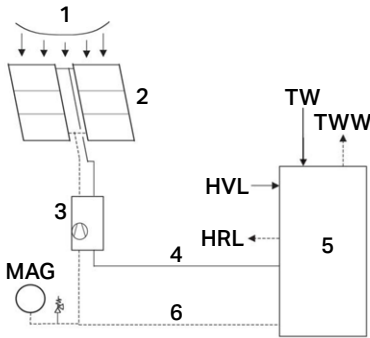

Figure 66: Solar systems

- | | |
|-----|---------------------|
| 1 | Solar radiation |
| 2 | Solar collectors |
| 3 | Pump group |
| 4 | Solar inlet flow |
| 5 | Solar storage tank |
| 6 | Solar return flow |
| TW | Cold drinking water |
| TWW | Hot drinking water |
| HVL | Heating inlet flow |
| HRL | Heating return flow |

Geberit Mapress pressfitting systems

The following Geberit Mapress pressfitting systems can be used for closed solar installations:

- Geberit Mapress Stainless Steel Solar and Industry
- Geberit Mapress Copper Solar and Industry

The following restrictions must be observed:

Fluid:	Water / glycol mix
Minimum temperature:	-25 °C
Maximum temperature:	180 °C for 200 hours/year
	200 °C for 180 hours/year
	220 °C for 500 hours during the life of the system

see table 88 on page 111 provides an overview of the tested and approved antifreeze agents with corrosion protection.

Ready to use antifreezes based on glycol always contain other additives. All additives must be checked for compatibility with the seal rings and approved by Geberit.

It is advisable not to use pressfittings next to the solar panel as temperatures in the pipework can become highly elevated when the system is not running and could damage the Geberit Mapress seal ring.

2.1.8 Sprinkler systems

The following Geberit Mapress pressfitting systems can be used for sprinkler systems:

- Geberit Mapress Stainless Steel
- Geberit Mapress Carbon Steel, inside and outside zinc-plated
- Geberit Mapress Copper

Sprinkler system water pipes are categorised as follows:

- "Wet" extinguishing water pipes: The riser pipe is wet and constantly filled with drinking water
- "Dry" extinguishing water pipes: The riser pipe is dry and if necessary, is filled and operated with nondrinking water by the fire brigade
- "Wet / dry" extinguishing water pipes: The riser pipe is dry and if necessary, is filled and operated with water from the potable water network via remote actuation of taps

Geberit Mapress Stainless Steel and Geberit Mapress Copper are suitable for all systems, with operating pressure up to 16 bar. Geberit Mapress Carbon Steel inside and outside zinc-plated pipes can only be used for wet systems with non-potable water (up to 16 bar).

Geberit Mapress holds the following approvals for sprinkler systems:

VdS:

- Geberit Mapress Stainless Steel 1.4401 with black CIIR seal ring for wet systems 22 - 108 mm
- Geberit Mapress Stainless Steel 1.4401 with FPM red seal ring for dry systems 22 - 108 mm
- Geberit Mapress Carbon Steel inside and outside zinc-plated wet systems with black CIIR seal ring 22 - 108 mm

The approval includes the fire protection classes LH, OH1, OH2, OH3 and select risks of OH4 (theatres, cinemas and concert halls).

FM:

- Geberit Mapress Stainless Steel 1.4401 with black CIIR seal ring for wet/dry systems 22 - 108 mm
- Geberit Mapress Carbon Steel inside and outside zinc-plated wet systems with black CIIR seal ring 22 - 54 mm

Various approvals for shipbuilding are also held - contact us for details.

2.1.9 Oil supply installation

Mineral oil

Today mineral oil is used as a fuel and a lubricant. Due to its versatility, mineral oil is very much in demand, for example as a fuel for industrial, commercial and domestic use, as a lubricant or base material in the chemical industry.

Heating oil EL

Heating oil EL (extra light) is often used in households as a fuel for heat generation. In addition to heating oil EL, there is also heating oil S for large-scale plants. Heating oil S must be heated for transport, as it is a more viscous fluid.

Geberit Mapress pressfitting systems

The following Geberit Mapress pressfitting systems can be used for oil supply installations without restriction:

- Geberit Mapress Stainless Steel Solar and Industry
- Geberit Mapress Carbon Steel Solar and Industry

2.1.10 Special applications

Condensate drains for condensing boilers

Principles

In these appliances in addition to the thermal energy in the waste gas, the evaporation enthalpy of the steam contained in the waste gas is utilised.

In gas applications the condensing boiler is used for heating and hot water (dewpoint approximately 55 °C). The occurring condensate must be routed to the sewer through a condensate drain. The pH value of the condensate is between 3.5 and 5.2.

In addition to gas condensing boilers, there are also versions which run with heating oil EL (dewpoint approx. 50 °C). The pH value of the condensate in this case is between 2.5 and 3.5 and it can contain sulphurous acid.

The condensate of the condensing boilers only contains a low concentration of fluorocarbons. Fluorocarbons promote corrosion in the heating section of the device and in the waste gas pipes and condensate pipes. If there is an emission source of fluorocarbons directly nearby, the installation room or combustion air supply of the device must be selected so that these contaminants are not supplied to the condensate with the combustion air.

Geberit Mapress pressfitting systems

The following Geberit Mapress pressfitting systems can be used for condensate discharge:

- Geberit Mapress Stainless Steel

Geberit Mapress Stainless Steel

Geberit Mapress Stainless Steel is resistant against the condensate of gas burners and can be used for this type of condensate drain.

Geberit Mapress Stainless Steel cannot be used for condensate drains from oil condensing boilers.

Disinfectant solutions

The following Geberit Mapress pressfitting systems can be used for disinfectant solutions:

- Geberit Mapress Stainless Steel

Geberit Mapress Stainless Steel can be used in swimming baths or hospitals for surface disinfection and for preventing athletes foot using disinfectant solutions.

The following table provides an overview of the tested and approved disinfectants.

Table 89: Tested and approved disinfectants Geberit Mapress Stainless Steel

Additive ¹⁾	Seal ring material	Application / Concentration	Manufacturer ²⁾
	CIIR		
NÜSCOSEPT	X	0.5 - 2 % solution	Dr. Nüsken Chemie
HEXAQUART S	X	0.5 - 3 % solution	B. Braun & Meslungen AG
MULTIDOR	X	0.25 - 1 % solution	Henkel Hygiene
MYXAL S	X	0.1 - 2 % solution	Physioderm GmbH
QUATAMON MED	X	1.0 - 2 % solution	S. & M. Schülke & Mayr GmbH
TERRALIN	X	0.25 - 2 % solution	S. & M. Schülke & Mayr GmbH

1) Used in swimming pools, hospitals etc. for surface disinfection

2) The manufacturer's instructions for use must always be observed

2.2 Industrial applications

As well as building applications, the Geberit Mapress system is suitable for many industrial uses.

i The country-specific regulations and guidelines must be observed in the following descriptions for industry applications.

2.2.1 Compressed air installation

Principles

Compressed air has a wide range of applications. This medium is used in almost all fields of the producing and processing industries.

Due to the special safety requirements at high pressures and the high energy costs for the generation and maintenance of compressed air, sufficient but low operating pressures should be selected.

Depending on the application, various requirements must be met by compressed air installations:

- Residual oil content
- Moisture content
- Purity

Compressed air can also contain oil to lubricate downstream consumers. If purity requirements are high, a drier or oil separator is used.

These specifications must be clarified at the planning stage of compressed air supply for the selection of materials and systems.

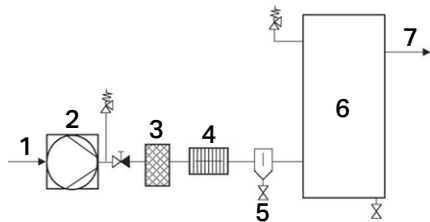

Figure 67: Diagram of a compressed air system

- 1 Air supply
- 2 Compressor
- 3 Oil separator
- 4 Aftercooler
- 5 Water separator
- 6 Compressed air vessel
- 7 Consumers

Geberit Mapress pressfitting systems

The following Geberit Mapress pressfitting systems can be used for compressed air installations:

- Geberit Mapress Stainless Steel
- Geberit Mapress Carbon Steel
- Geberit Mapress Copper

* with a maximum working pressure of 16 bar.

Geberit Mapress Carbon Steel can only be used in dry compressed air systems, otherwise any humidity and air contained in the installation system may lead to corrosion.

Geberit Mapress seal rings

Residual oil exists in most compressed air systems to lubricate tools and reduce corrosion. Compressed air is categorised depending on the amount of oil present in the system.

If there is a residual oil content of $> 1 \text{ mg/m}^3$, the FKM blue seal ring should be used due to its higher oil resistance.

Table 90: Suitable Geberit Mapress seal rings for compressed air lines with residual oil content according to ISO 8573-1 2001

Compressed air categories	\leq Residual oil quantity _{max} [mg/m ³]	Geberit Mapress seal ring
1	0.01	CIIR black / FKM blue
2	0.10	CIIR black / FKM blue
3	1.00	CIIR black / FKM blue
4	5.00	FKM blue

Table 91: Maximum operating pressure of Geberit Mapress for compressed air installations

Operating pressure max. [bar]	Geberit Mapress Stainless Steel 1.4401 ø [mm]	Geberit Mapress Carbon Steel ^{1) 2)} ø [mm]	Geberit Mapress Copper ø [mm]
12	88.9 - 108 ²⁾	76.1 - 108	15 - 108
16	76.1	35 - 54	-
25	12 - 54	12 - 28	-

¹⁾ Geberit Mapress Carbon Steel system pipes outside zinc-plated and Geberit Mapress Carbon Steel system pipes plastic-coated are only suitable for dry compressed air

²⁾ Higher pressures on request

Care must be taken that a professional connection of the pressed joint is made and that the insertion distance is maintained.

We recommend moistening the seal ring with soap solution or water before installing so as to improve the lubrication effect of the seal ring and ensure optimum sealing of the connection for compressed air.



Geberit Mapress is suitable for inert gases (non-explosive and non-toxic) such as nitrogen, argon and carbonic acid.

2.2.2 Vacuum lines

The following Geberit Mapress pressfitting system can be used for vacuum lines up to 200 mbar absolute (reduction of the ambient air pressure from 1 bar to 0.2 bar):

- Geberit Mapress Stainless Steel
- Geberit Mapress Carbon Steel, inside and outside zinc-plated

2.2.3 Saturated steam applications

The following Geberit Mapress pressfitting systems can be used for saturated steam applications only after consulting Geberit:

- Geberit Mapress Stainless Steel

The factory pre-mounted black seal ring CIIR is not suitable for use in saturated steam systems.

The approved seal ring FKM white made of tetrafluoroethylene propylene rubber will be supplied separately for this application. This replaces the factory pre-mounted seal ring CIIR black. The replacement is carried out on-site by the plumber.



The Pressure Equipment Directive must be observed when using Geberit Mapress Stainless Steel together with the seal ring FKM white.

2.2.4 Fuels and oils of hazard category A III

The following Geberit Mapress pressfitting systems can be used when transporting fuels, engine oils and transmission oils of hazard category A III:

- Geberit Mapress Stainless Steel Solar and Industry
- Geberit Mapress Carbon Steel Solar and Industry

Use FKM blue seal rings made of fluorinated rubber for these applications.

2.2.5 Pipelines carrying sea water

The following Geberit Mapress pressfitting systems can be used for pipelines carrying sea water:

- Geberit MapressCuNiFe

The following operating conditions must be observed:

- Operating pressure: 10 - 13 bar
- Operating temperature: -20 °C - +120 °C

The operating pressure is dependant on the approval and dimension.

2.2.6 Applications Geberit MapressCuNiFe

Geberit MapressCuNiFe is suitable for the following uses:

Table 92: Applications Geberit MapressCuNiFe

Application	Geberit Mapress seal ring
Seawater sanitary systems	CIIR black
Air conditioning	CIIR black
Deck wash systems	CIIR black
Sanitary grey / black water drainage	CIIR black
Sprinkler	CIIR black
Fire main / water spray foam	CIIR black
Freshwater cooling	CIIR black
Seawater cooling	CIIR black
Compressed air	CIIR black / FKM blue ¹⁾
Inert gas	CIIR black
Hydraulic oil	FKM blue
Fuel oil	FKM blue
Cargo oil	FKM blue
Lubrication oil	FKM blue
Bilge systems	CIIR black
Ballast systems	CIIR black

¹⁾ Please see table 90 on page 116

Shipbuilding approvals

In shipbuilding the Geberit Mapress pressfitting connection is approved by the following classification societies:

- Lloyd's Register of Shipping (LRS)
- American Bureau of Shipping (ABS)
- Bureau Veritas (BV)
- Bundesamt für Wehrtechnik und Beschaffung (BWB)
- Det Norske Veritas (DNV)
- Germanischer Lloyd (GL)
- Registro Italiano Navale (RINA)
- Nippon Kaji Kyokai
- Factory Mutual (FM)
- Vertrauen durch Sicherheit (VdS)

Geberit International Sales AG
CH-8640 Rapperswil
Switzerland

sales@geberit.com

→ www.international.geberit.com