

APPLICATION TECHNIQUE

GEBERIT MAPRESS

VALID FROM 31 JANUARY 2022

**KNOW
HOW
INSTALLED**

CONTENT

1 PRINCIPLES

1.1	Geberit Mapress	5
1.1.1	Overview of Geberit Mapress	5
1.1.2	Resistance to liquid and gaseous media	6
1.1.3	Pressed joint	7
1.1.4	Colour concept of Geberit Mapress pressfittings	11
1.1.5	Certification	12
1.1.6	Transport and storage	12
1.1.7	Maintenance and repair	13
1.1.8	Disposal	16
1.2	Geberit Mapress Stainless Steel	17
1.2.1	Overview of Geberit Mapress Stainless Steel systems	17
1.2.2	System components	19
1.2.3	Pipe marking	26
1.2.4	Application examples for fittings	27
1.2.5	System characteristics	32
1.2.6	Certificates for Geberit Mapress Stainless Steel	32
1.2.7	Technical data	33
1.3	Geberit Mapress Carbon Steel	39
1.3.1	Overview of Geberit Mapress Carbon Steel	39
1.3.2	System components	41
1.3.3	Pipe marking	46
1.3.4	Application examples for fittings	47
1.3.5	System characteristics	55
1.3.6	Geberit Mapress Carbon Steel certificates	55
1.3.7	Technical data	56
1.4	Geberit Mapress Copper	63
1.4.1	Overview of Geberit Mapress Copper	63
1.4.2	System components	64
1.4.3	Marking of copper pipes according to EN	70
1.4.4	Application examples for fittings	70
1.4.5	System characteristics	79
1.4.6	Certificates for Geberit Mapress Copper	80
1.4.7	Technical data	80

1.5	Geberit Mapress CuNiFe	86
1.5.1	Overview of Geberit Mapress CuNiFe	86
1.5.2	System components	86
1.5.3	Marking of Geberit Mapress CuNiFe system pipes	90
1.5.4	System characteristics	90
1.5.5	Geberit Mapress CuNiFe certificates	90
1.5.6	Technical data	91
2	PRACTICAL USE	
2.1	Determination of the pipe dimension	95
2.1.1	Loading units	95
2.1.2	Geberit loading unit tables	96
2.2	Calculations with pressure losses	97
2.2.1	Total pressure loss in an installation	97
2.2.2	Pressure loss through pipe friction in pipes	97
2.2.3	Pressure loss diagrams for Geberit Mapress Stainless Steel system pipes	98
2.2.4	Pressure loss from individual resistances	99
2.2.5	Square Law	103
2.3	Hot water draw-off times	104
2.3.1	Reference values for draw-off times	104
2.3.2	Determination of the draw-off time according to SIA 385/1	105
2.4	Assignment of Geberit pipe dimensions to nominal widths	107
2.5	Thermal expansion of pipes	108
2.5.1	Positioning of anchor points and sliding points	108
2.6	Absorption of the change in length	110
2.6.1	Expansion space or insulation	110
2.6.2	Deflection legs as an expansion compensator	111
2.6.3	Axial expansion fitting as an expansion compensator	144
2.7	Insulation of pipe systems	149
2.7.1	Insulation of potable water pipes	149
2.7.2	Insulation thicknesses for cold-water pipes according to DIN 1988-200	150
2.7.3	Insulation thicknesses for hot water pipes according to the Building Energy Act	150
2.7.4	Sound insulation	151
2.8	Corrosion	152
2.8.1	Corrosion behaviour of Geberit Mapress Stainless Steel	152
2.8.2	Corrosion behaviour of Geberit Mapress Carbon Steel	157
2.8.3	Geberit Mapress Carbon Steel system pipes in solar thermal systems	161
2.8.4	Corrosion behaviour of Geberit Mapress Copper	162
2.8.5	Corrosion behaviour of Geberit Mapress CuNiFe	164

2.9	Pipe laying	166
2.9.1	Basic laying process	166
2.9.2	Storey distribution	167
2.9.3	Installation on uncovered concrete floors	169
2.10	Pipe fixation	170
2.10.1	Fastening of pipes with anchor and sliding points	170
2.10.2	Pipe bracket spacing for drinking water installations	170
2.10.3	Pipe bracket spacing for sprinkler and extinguishing water systems	171
2.10.4	Thickness of the pipe fixation for sliding points	171
2.10.5	Installation dimensions of Geberit mounting plates	172
2.10.6	Minimum distances for pressing	173
2.10.7	Space requirements when pressing with Geberit Mapress pressing jaws	174
2.10.8	Space requirements when pressing with Geberit Mapress pressing collars	175
2.10.9	Space requirements when pressing with Geberit pressing tool HCPS	176
2.11	Pipework	177
2.11.1	Processing temperature	177
2.11.2	Cutting of bare system pipes to length	177
2.11.3	Cutting of system pipes with a plastic jacket to length	178
2.11.4	Deburring of system pipes	179
2.11.5	Bending system pipes	180
2.11.6	Determination of the insertion distance	180
2.12	Pressing preparations	181
2.12.1	Connection with a threaded fitting	182
2.12.2	Alignment of pipes	182
2.13	Creating a pressed joint	183
2.13.1	Pressing operation for the dimension d108 mm	184
2.14	Pressing tools	186
2.14.1	Pressing tools and pressing attachments	186
2.14.2	Maintenance and service plans for Geberit Mapress pressing jaws	186
2.14.3	Using the Geberit PowerTest	187
2.14.4	Maintenance plan for the service-free adapter jaw 203 A	190
2.14.5	Maintenance and service plans for Geberit Mapress pressing collars and adapter jaws	190
2.14.6	Maintenance and service plans for pressing tools	192
2.15	Commissioning	194
2.15.1	General pressure test	194
2.15.2	Pressure test on drinking water installations	194
2.15.3	Pressure testing of gas installations	196
2.15.4	Rules for the pressure testing of heating and water heating installations	196
2.15.5	Initial filling and flushing	196





1.1 GEBERIT MAPRESS

1.1.1 Overview of Geberit Mapress

Geberit Mapress are supply systems made of metal, where the pipes and fittings are connected by pressing them together to create permanent, technically tight pipes.

Geberit Mapress supply systems comprise four different metals.

Geberit offers service-free pressing jaws as well as pressing collars, adapter jaws and pressing tools for pressing pipes and fittings.

Geberit Mapress system		System pipe material
Geberit Mapress Stainless Steel		<ul style="list-style-type: none"> • CrNiMo steel 1.4401 • CrNiMo steel 1.4401 with PP jacket • CrMoTi steel 1.4521 • CrNi steel 1.4301
Geberit Mapress Carbon Steel		<ul style="list-style-type: none"> • Non-alloy steel 1.0034, outside zinc-plated • Non-alloy steel 1.0034, outside zinc-plated, with PP jacket • Non-alloy steel 1.0215, inside and outside zinc-plated
Geberit Mapress Copper		<ul style="list-style-type: none"> • Copper CW024A according to EN 1057
Geberit Mapress CuNiFe		<ul style="list-style-type: none"> • Copper-nickel-iron alloy CuNi10Fe1.6Mn, 2.1972.11

1.1.2 Resistance to liquid and gaseous media

In addition to their use for drinking water and heating water, Geberit supply systems can also be used for other liquid and gaseous media. The medium itself may be modified due to the pipes or fittings. The suitability of the Geberit supply systems for different media is therefore not only derived from the resistance of the pipes, but also depends on the medium's intended use.



The current usage overviews can be found in the online catalogue or in the printed catalogue.

If Geberit supply systems are intended for media other than those listed, the resistance of the pipe and sealing materials must be checked and approved by Geberit.

The following are required for the approval:

- product and safety data sheets of the medium
- indication of the concentration
- exposure time, frequency and flow rate
- sample of the medium (only after consultation)
- planned operating temperature
- planned operating pressure
- maximum malfunction temperature
- ambient conditions (e.g. pipe layout through cleanroom, high humidity, permanent moisture, aggressive environment)

Resistance-related enquiries can be made online via the website of the Geberit sales companies.

The Geberit Industrial Application Tool is available at <https://industryenquiry.geberit.com/> to assist in selecting a suitable piping system.

1.1.3 Pressed joint

The basic element of a pressed joint is the pressfitting.

The pressing of pressfittings and a system pipe creates positively and lengthways locked, tight pipe connections.

Geberit Mapress pressed joint

Geberit Mapress pressed joints are created with Geberit pressing tools or with compatible pressing tools using the original Geberit pressing attachments (pressing jaws, pressing collars, adapter jaws).

Pipe diameters of 12–35 mm are pressed with pressing jaws. This creates a pressed joint, referred to as a "hexagon", externally recognisable by the hexagonal pressing imprint.

Pipe diameters of 35–108 mm are pressed with pressing collars and the corresponding adapter jaws. This creates a pressed joint, referred to as a "lemon-shaped contour", externally recognisable by the lemon-shaped pressing imprint.

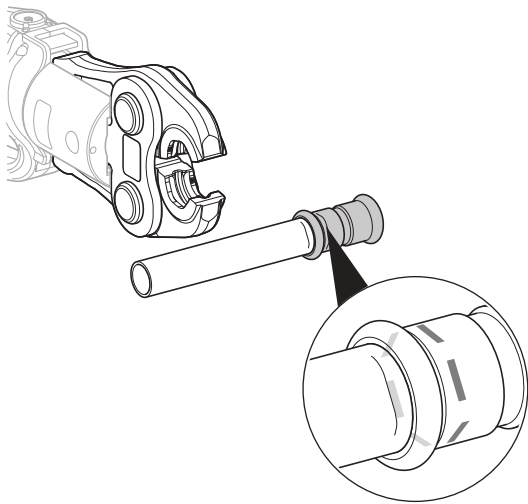

Figure 1: Pressed joint created with a pressing jaw (hexagon)

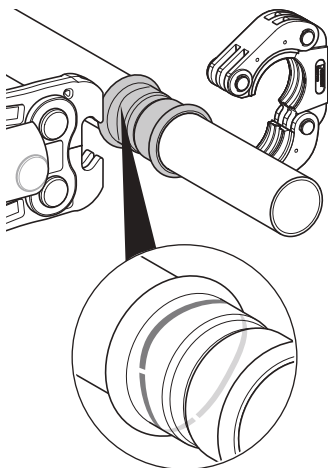

Figure 2: Pressed joint created with a pressing collar (lemon-shaped contour)

Structure of the Geberit Mapress pressfitting

The structure of the Geberit Mapress pressfitting is shown using the Geberit Mapress threaded socket as an example.

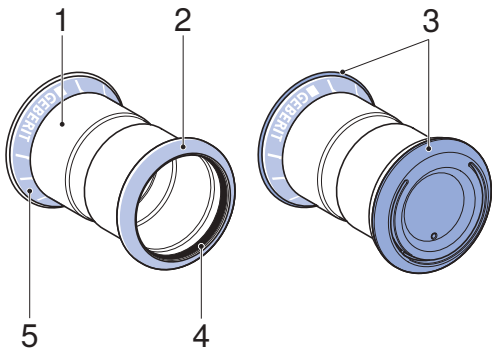

Figure 3: Structure of the Geberit Mapress threaded socket

- 1 Fitting body
- 2 Moulded fitting bead
- 3 Protection plug
- 4 Seal ring
- 5 Pressing indicator

Seal ring

The special contour of the seal ring CIIR, black and HNBR, yellow ensures that unpressed fittings are leaky during the pressure test, thus preventing later damage during operation.

The use of individual seal rings with the different Geberit Mapress systems complies with the respective approvals.

Seal ring	Leaky if unpressed
CIIR, black	✓
HNBR, yellow	✓
EPDM, black	✗
FKM, blue	✗
FKM, white	✗
FPM, red	✗

- ✓ Applies
- ✗ Does not apply

Protection plug

The protection plug protects the inside of the fitting and the seal ring from dust and dirt. The colour of the protection plug indicates the area of application.

Pressing indicator

The pressing indicator contains the following information:

- The colour of the pressing indicator indicates the fitting material.
- The pressing indicator indicates the fitting manufacturer and dimensions.
- An intact pressing indicator indicates an unpressed connection.
- A destroyed, easy-to-remove pressing indicator indicates a pressed connection.

Pressing operation

When pressing the pressfitting with the system pipe inserted, the pressing socket, fitting bead and pipe are deformed. This creates a pressed joint that is characterised by two features:

- The deformation of the pressing sockets ensures the strength of the connection.
- The deformation of the fitting bead with the seal ring ensures the tightness of the connection.

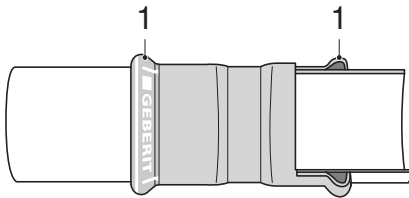

Figure 4: Pressed joint before pressing

- 1 Unpressed fitting bead with pressing indicator and inserted seal ring

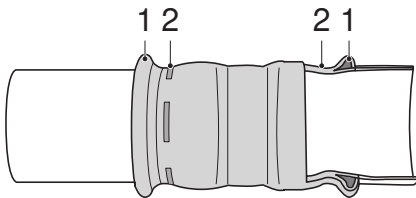
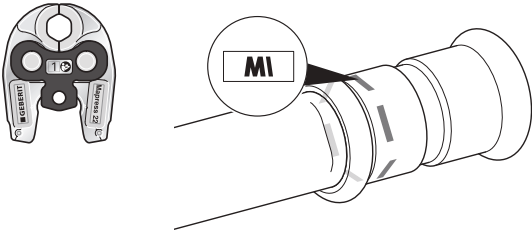
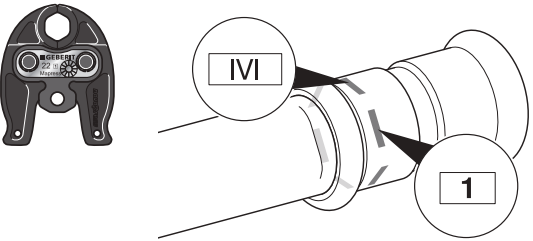
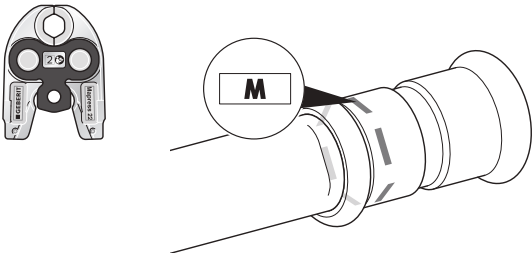
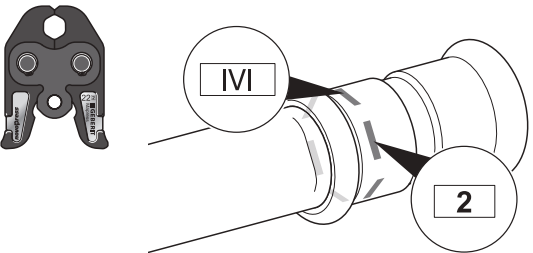
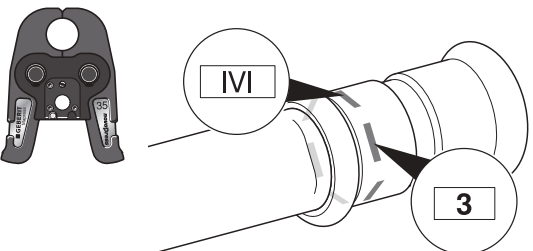
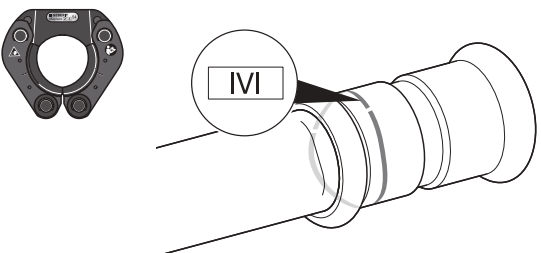

Figure 5: Pressed joint after pressing

- 1 Deformed fitting bead
2 Deformed pressfitting / deformed pipe

Marking of the pressed joint

When Geberit pressing tools are used, an embossed marking can be detected on the pressing imprint of the pressed joint. The marking shows which pressing attachment was used.

Compatibility	Pressing jaw, zinc-plated	Pressing jaw, black
[1]		
[2]		
[3]	-	
Compatibility	Pressing collar, black	
[2] [2XL] [3] [4]		

- Does not apply





















Information on the compatibility of pressing attachments and pressing tools

In order to be able to assign the pressing attachments to the pressing tools, Geberit has introduced compatibilities. Compatibility is indicated in the documents by a number in square brackets, e.g. [2], and on the products in a frame, e.g. [2]. The Technical Information on compatible pressing tools provides an overview of the compatible pressing tools for Geberit pressing systems, which is updated annually.

1.1.4 Colour concept of Geberit Mapress pressfittings

The colour of the pressing indicators on the pressfittings allows a clear assignment of the pressfitting to a Geberit Mapress system.

The colour of the protection plugs indicates the application for which the fitting is suitable. The colour of the protection plugs also indicates which seal ring is inserted in the pressfitting.

	Protection plug					
	Transparent for basic applications		Yellow for gas applications		Black for special applications	
Blue pressing indicator for stainless steel		CIIR, black 		HNBR, yellow 		FKM, blue 
Red pressing indicator for carbon steel			X			
White pressing indicator for copper						
Black pressing indicator for CuNiFe			X			

X Material not suitable for gas applications

1.1.5 Certification

Certification of Geberit sites

The Geberit sites are certified according to EN ISO 9001.

Certificates for Geberit Mapress systems

In most countries, the Geberit Mapress systems have the necessary certificates for a variety of applications. For example, the use of Geberit Mapress systems for the following applications is covered by certificates:

- drinking water installations
- gas installations
- water extinguishing systems such as sprinkler systems and extinguishing water systems
- industrial applications
- shipbuilding



Certificates apply exclusively for the tested Geberit Mapress system, pressed with Geberit pressing tools, consisting of Geberit Mapress fittings and Geberit Mapress system pipes or Geberit Mapress fittings and copper pipes according to EN 1057.

Combinations of Geberit Mapress system components and third-party components are not covered by the certificates. The Geberit system warranty will expire in such mixed installations.

1.1.6 Transport and storage

Transport and storage rules

The rules for the correct handling of Geberit system pipes during transport and storage are used to protect the pipes from possible damage due to incorrect handling.

These rules do not include any information on health and safety regulations and accident prevention regulations in the handling of long goods. These regulations are country-specific and must be observed by the forwarding agent, stockkeeper and by all other people involved in the transport.

Transport

The following rules must be observed when transporting Geberit system pipes:

- When loading and unloading, make sure that the pipes do not become dirty or damaged. The pipes must not be pulled over the sill or thrown.
- The pipes must be secured against slipping during transport. If the pipes hit the front or rear wall of the loading area during transport, the pipe ends may be damaged or the protection plugs may be pressed into the pipes.
- The pipes may only be transported in closed loading areas.

Storage

The following rules must be observed when storing Geberit Mapress system pipes in order to avoid damage due to incorrect damage and mistakes.

- System pipes must be transported and stored in the original packaging. The original packaging protects the pipe ends against damage and ensures that the pipes can be handled safely.
- If the pipes cannot be transported and stored in their original packaging, another method of protecting them must be used.
- The pipes must only be stored in a dry and well-ventilated storage area. They must be protected from atmospheric influences and moisture. The temperature must not drop below the dew point.
- In order for air to flow around the pipes and for moisture on the pipe surface to dry more quickly and so that the pipe surface is not scratched or damaged, the pipes must be stored on cantilever-type shelves or dry squared timber. At least 3 contact points must be provided. The pipes must not sag.
- Foil must not be used to protect the pipes against dirt or moisture as foil promotes the formation of condensation. An exception here is the Geberit Mapress Carbon Steel system pipe (plastic-jacketed), which is supplied with a foil hose in order to protect the plastic jacket against dust.
- Different materials must be stored separately.
- If the pipes cannot be stored separately according to the pipe dimensions, the smaller pipe dimensions must always be stored on top of the larger pipe dimensions.
- In order to prevent galvanic corrosion, Geberit Mapress Stainless Steel system pipes and Geberit Mapress Carbon Steel system pipes must be stored separately.
- Mixed pallets must be opened after transporting and stored based on their type.

1.1.7 Maintenance and repair

Descaling of pipes

Geberit supply systems for drinking water are designed for maintenance-free operation. Malfunctions can occur due to limescale deposits in the pipe if the operating conditions are not matched to the existing water quality.

Limescale deposits that cause malfunctions (e.g. reduced water flow) in Geberit supply systems can be removed with suitable descaling agents and in accordance with the following rules:

- Only sulfamic acid or citric acid-based descaling agents must be used.
- The descaling agent must contain a corrosion-protection agent and be approved by the manufacturer for use with non-ferrous heavy metals.
- Approved descaling agents must be used for the descaling of drinking water pipes.
- Under no circumstances should the descaling agent come into contact with the aluminium on the front-end connection points of the multilayer pipes.
- The concentration for use and application time (max. 8 hours) of the descaling agent specified by the manufacturer must be observed.
- The descaling agent must be used at room temperature (max. 25 °C).
- After descaling, the pipes must be flushed thoroughly. The pH value must then be checked at the points of use. Acid must no longer be detectable.
- Before descaling, hot water pipes must be flushed with cold water until the temperature at all points of use is below the application temperature.
- The piping system must be open so that the pressure generated by the descaling process can escape if need be.
- Mechanical removal of the limescale deposits is not admissible as the surface of the system pipe may be damaged.
- Geberit recommends the rapid descaler 548 (3% concentration according to the manufacturer) made by the company Halag Chemie AG from Aadorf (tel. +41 58 433 68 68).

Water treatment to avoid limescale deposits in accordance with DIN 1988-200

The tendency of the water to calcify depends on many factors, above all:

- water temperature
- calcium carbonate mass concentration of drinking water

The following measures are suitable to prevent limescale deposits in accordance with DIN 1988-200:2012-05:

- water softening by ion exchange through water softeners that meet the respective applicable minimum requirements, e.g. the requirements of DIN EN 14743 and DIN 19636
- controlled addition of chemical solutions within the framework of the respective applicable standards and regulations
- installation of lime protection devices to reduce the formation of stones in the treated water

Table 1: Measures to avoid limescale deposits depending on the calcium carbonate mass concentration (mmol/l) and the average temperature of the drinking water

Calcium carbonate mass concentration mmol/l	Measures at $\bar{\delta} = \leq 60 \text{ °C}$	Measures at $\bar{\delta} = \geq 60 \text{ °C}$
< 1.5 (Corresponds to < 8.4 °dH, soft hardness range)	None	None
≥ 1.5 to < 2.5 (Corresponds to $\geq 8.4 \text{ °dH}$ < 14 °dH, medium hardness range)	None or stabilisation or softening	Stabilisation or softening recommended
≥ 2.5 (Corresponds to $\geq 14 \text{ °dH}$, hard hardness range)	Stabilisation or softening recommended	Stabilisation or softening

$\bar{\delta}$ Controller temperature

Disinfection of drinking water installations

Principles

Drinking water installations must only be disinfected in proven cases of contamination and only for a limited time. Prophylactic disinfection contradicts the principle of minimisation of the Drinking Water Ordinance. Disinfection of drinking water installations is only successful when all sources of contamination have been removed. The limit values for disinfectant concentration specified in the Drinking Water Ordinance are maximum values, which were set with due consideration of hygienic and toxicological viewpoints. They do not allow any automatic conclusions to be drawn about the resistance of the materials used to disinfectants. Drinking water installations may only be disinfected by skilled persons. The disinfection measures must be recorded in writing.



The disinfection measures place a strain on the materials and components of the potable water installation and may adversely affect its service life. Disinfection measures carried out incorrectly can damage the potable water installation.

Methods of disinfection

Drinking water installations and washbasin taps can be disinfected using thermal or chemical methods. Drinking water can also be disinfected by means of UV radiation.

A combined thermal-chemical disinfection is not admissible.

Thermal disinfection

In the case of thermal disinfection, microorganisms that are found in water are killed off by the effects of temperature.

The following rules must be observed during thermal disinfection:

- The piping system must be thoroughly rinsed before the disinfection process is performed.
- The water heater and the entire circulation must be heated up to at least 70 °C.
- All points of use must be opened step by step or line by line respectively.
- Hot water must be allowed to run at all points of use for at least 3 minutes at 70 °C.
- The temperatures must not decrease during the disinfection process.
- Risk of scalding must be eliminated by taking suitable measures.
- Performance of the disinfection process must be documented in a report.

Chemical disinfection

Effective killing or inactivation of microorganisms is only possible if the disinfectant used can act on the microorganisms directly. In the case of chemical disinfection, a disinfectant is therefore used in a sufficient concentration in all areas of the drinking water installation.

Chemical disinfection is only carried out when microbiological limit values in accordance with the Drinking Water Ordinance are exceeded and these limit values cannot be eliminated by flushing and cleaning the drinking water installation. Prophylactic and recurrent disinfection contradicts the principle of minimisation of the Drinking Water Ordinance.

The limit values for disinfectant concentration specified in the Drinking Water Ordinance are maximum values, which were set with due consideration of hygienic and toxicological viewpoints. They do not allow any automatic conclusions to be drawn about the resistance of the materials used to disinfectants.

A distinction is made between the following chemical disinfection techniques:

- system disinfection
- drinking water disinfection



Chemical disinfectants corrode the drinking water installation and must only be used in the event of contamination.

Using a combination of several chemical disinfectants is not admissible.

Chemical disinfection can be performed several times throughout the service life of the drinking water installation. The disinfection measures, however, place a strain on the materials and components of the drinking water installation and may adversely affect its service life. It is not possible to provide a specification on the reduction in service life depending on the number of chemical disinfections performed.

System disinfection

For system disinfection, a disinfectant in a high concentration is added to a cold-water pipe over a short period of time.

Geberit piping systems and Geberit washbasin taps are suitable for system disinfection.

The following rules apply when carrying out system disinfection:

- Concentrations, temperatures and application times of the permitted disinfectants must be adhered to in strict compliance with country-specific regulations (see Table 1).
- Skilled persons must take specific measuring and control technology precautions.
- To prevent increases in concentration, the specific characteristics of the affected drinking water installation must be taken into account.
- Concentrations, temperatures and application times must be documented.
- Cleaning and disinfection protocol must be completed according to DVGW W 557.
- To remove disinfectant and dead germs after disinfection is complete, the drinking water installation must be flushed thoroughly with hygienically perfect drinking water.
- All points of use must be flushed until the limit value of the Drinking Water Ordinance is reached.
- No drinking water may be consumed during disinfection and the subsequent flushing phase.

Drinking water disinfection

For drinking water disinfection, a disinfectant in a low concentration is added to the drinking water pipe (cold or hot) for a limited time.

Geberit piping systems and Geberit washbasin taps are suitable for time-limited drinking water disinfection.

The following rules apply when carrying out drinking water disinfection:

- Concentrations, temperatures and the duration of application of the permitted disinfectants must be adhered to in strict compliance with the country-specific regulations.
- Skilled persons must take specific measuring and control technology precautions.
- To prevent increases in concentration, the specific characteristics of the affected drinking water installation must be taken into account.
- Concentrations, temperatures and by-products must be monitored and documented directly after the dosing point using measurement technology.
- The concentration of the agent in the treated water must be measured daily.
- Due to the principle of minimisation of the Drinking Water Ordinance, drinking water disinfection must be kept as short as possible; it should last no longer than it takes for technical rehabilitation to be completed.

Exceeding the concentration for use and duration can adversely affect the service life of the piping system.

UV disinfection

Geberit Mapress piping systems

Geberit Mapress piping systems are suitable for UV disinfection without restriction.

1.1.8 Disposal

Recycling



At the end of its service life, the Geberit Mapress system can be broken down into its individual parts and recycled according to the materials.

Table 2: Recycling of Geberit Mapress

Component	Material	Recycling	Remarks
System pipes	CrNiMo steel 1.4401	Scrap metal	Material collection by recycling companies
System pipes	CrMoTi steel 1.4521	Scrap metal	
System pipes	CrNi steel 1.4301	Scrap metal	
Fittings made of metal	CrNiMo steel 1.4401	Scrap metal	
Protective caps and plugs	PE-LD/PE-HD	Plastic recycling	
Outer packaging	PE Cardboard box	Plastic recycling Paper recycling	

Recycling code for the pressing indicator and protection plug

Table 3: Plastic elements in Geberit Mapress pressfittings

Plastic element	Material designation	Abbreviation	Recycling code
Pressing indicator	Multilayer film	PET-PS-PET	 01 PET
Protection plug	Polyethylene, low-density	PE-LD	 04 PE-LD

1.2 GEBERIT MAPRESS STAINLESS STEEL

1.2.1 Overview of Geberit Mapress Stainless Steel systems

Geberit Mapress Stainless Steel is a supply system with pipes made of austenitic or ferritic stainless steel, in which pipes and fittings are pressed into pipes.

Geberit Mapress Stainless Steel system pipes and fittings are characterised by good corrosion resistance. Due to the wide range of possible combinations of pipes, fittings and seal rings, the system covers a wide range of applications in technical building systems, industry and shipbuilding.

The most common uses are listed below for each Geberit Mapress Stainless Steel system. Other applications (media), together with the operating temperatures and operating pressures, are listed in the respective usage overviews.











The current usage overviews can be found in the online catalogue or in the printed catalogue.





The operating conditions specified in the relevant approvals, standards and technical regulations must be observed for each application. These may differ from the information in the usage overviews.





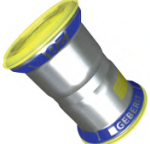

Geberit Mapress Stainless Steel

Seal ring	Fitting	System pipe	Combined pipe and fitting dimensions	Most common uses
CIIR, black 	CrNiMo steel 1.4401 	CrNiMo steel 1.4401 	d12–108 mm	<ul style="list-style-type: none"> • Cold and hot drinking water up to 100 °C • Cooling water with and without antifreeze agent • Treated water • Compressed air (oil class 0–3) • Industrial gases
CIIR, black 	CrNiMo steel 1.4401 	CrMoTi steel 1.4521 	d12–54 mm	<ul style="list-style-type: none"> • Cold and hot drinking water up to 100 °C • Cooling water with and without antifreeze agent • Treated water • Compressed air (oil class 0–3)
CIIR, black 	CrNiMo steel 1.4401 	CrNi steel 1.4301 	d15–108 mm	<ul style="list-style-type: none"> • Heating water up to 100 °C • Cooling water with and without antifreeze agent • Remote heating up to 120 °C • Compressed air (oil class 0–3) • Negative pressure

Geberit Mapress Stainless Steel, gas

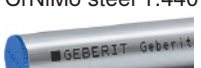
Seal ring	Fitting	System pipe	Combined pipe and fitting dimensions	Most common uses
 HNBR, yellow	 CrNiMo steel 1.4401	 CrNiMo steel 1.4401	d15–108 mm	<ul style="list-style-type: none"> Natural gases Liquefied gases Biogases











Geberit Mapress Stainless Steel, LABS-free

Seal ring	Fitting	System pipe	Combined pipe and fitting dimensions	Most common uses
 CIIR, black	 CrNiMo steel 1.4401	 CrNiMo steel 1.4401	d15–108 mm	Similar to Mapress Stainless Steel, but in environments that must be free of paint-wetting impairment substances, e.g. automotive production, paint shops
 CIIR, black	 CrNiMo steel 1.4401	 CrMoTi steel 1.4521	d15–54 mm	Similar to Mapress Stainless Steel, but in environments that must be free of paint-wetting impairment substances, e.g. automotive production, paint shops

Replacement of the seal ring for further applications with FKM, blue

The seal ring in the pressfitting can be easily replaced depending on the application purpose. The Geberit Mapress Stainless Steel pressfitting with the seal ring CIIR, black serves as the basis. Additional applications are therefore possible.

The following seal rings are available for replacement:

Seal ring	System pipe	Combined pipe and seal ring dimensions	Most common uses
 FKM, blue	 CrNiMo steel 1.4401	d15–108 mm	<ul style="list-style-type: none"> Remote heating up to 140 °C Thermal medium (solar) Mineral and lubricating oils Compressed air (oil class 0–X)
 FKM, blue	 CrMoTi steel 1.4521	d12–54 mm	<ul style="list-style-type: none"> Remote heating up to 140 °C Thermal medium (solar) Compressed air (oil class 0–X)
 FKM, blue	 CrNi steel 1.4301	d15–108 mm	<ul style="list-style-type: none"> Remote heating up to 140 °C Thermal medium (solar) Compressed air (oil class 0–X)
 FKM, white	 CrNiMo steel 1.4401	d15–108 mm	<ul style="list-style-type: none"> Saturated steam up to 155 °C
 FPM, red	 CrNiMo steel 1.4401	d22–108 mm	<ul style="list-style-type: none"> Extinguishing water wet/dry, dry Sprinklers, wet/dry, dry

1.2.2 System components

The Geberit Mapress Stainless Steel system consists of the following components:

- system pipes
- fittings with system seals
- pipe valve fittings
- accessories
- tools

System pipes

Geberit Mapress Stainless Steel system pipe CrNiMo



Outer diameter	12–108mm
Description	<ul style="list-style-type: none"> • Material number 1.4401 • Welded, thin-walled system pipe made of high-alloy austenitic, rustproof CrNiMo steel • Blue protection plug
Additional features guaranteed by the Geberit works standard	<ul style="list-style-type: none"> • Increased molybdenum content, minimum 2.2 % • Laser welded or TIG welded and smoothed on the inside • Heat treated (normalised)
Properties	<ul style="list-style-type: none"> • LABS-free¹⁾ Ex works, tested according to the technical regulation VDMA 24364:2018-05 • Pipe dimensions d12–54 mm can be bent using a standard bending tool

1) Free of paint-wetting impairment substances, such as silicone

Geberit Mapress Stainless Steel system pipe CrMoTi



Outer diameter	12–54 mm
Description	<ul style="list-style-type: none"> • Material number 1.4521 • Welded, thin-walled system pipe made of high-alloy ferritic, rustproof CrMoTi steel • Green protection plug • Green stripe
Additional features guaranteed by the Geberit works standard	<ul style="list-style-type: none"> • Increased molybdenum content, minimum 2.0 % • Laser welded or TIG welded and smoothed on the inside • Heat treated (normalised)
Properties	<ul style="list-style-type: none"> • LABS-free¹⁾ Ex works, tested according to the technical regulation VDMA 24364:2018-05 • Pipe dimensions d12–54 mm can be bent using a standard bending tool

1) Free of paint-wetting impairment substances, such as silicone

Geberit Mapress Stainless Steel system pipe CrNi



Outer diameter	15–108 mm
Description	<ul style="list-style-type: none"> • Material number 1.4301 • Welded, thin-walled system pipe made of austenitic, rustproof CrNi steel • With no protection plug • Red stripe
Additional features guaranteed by the Geberit works standard	<ul style="list-style-type: none"> • Laser welded or TIG welded and smoothed on the inside • Heat treated (normalised)
Properties	<ul style="list-style-type: none"> • Pipe dimensions d15–54 mm can be bent using a standard bending tool

Pressfittings

Geberit Mapress Stainless Steel pressfitting with seal ring CIIR, black



Outer diameter	12–108 mm
Description	<ul style="list-style-type: none"> • Pressfitting made of austenitic stainless steel 1.4401 • Seal ring CIIR, black • Blue pressing indicator • Transparent protection plug
Properties	<ul style="list-style-type: none"> • Increased molybdenum content, minimum 2.2 % • Leaky if unpressed

Geberit Mapress Stainless Steel pressfitting with seal ring HNBR, yellow, gas

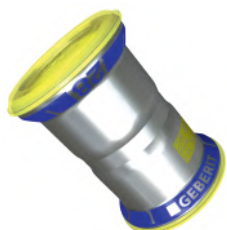

Outer diameter	15–108 mm
Description	<ul style="list-style-type: none"> • Pressfitting made of austenitic stainless steel 1.4401 • Seal ring HNBR, yellow, especially for gas installations • Yellow marking on the fitting body • Blue pressing indicator • Yellow protection plug
Properties	<ul style="list-style-type: none"> • Increased molybdenum content, minimum 2.2 % • Leaky if unpressed



The Geberit Mapress Stainless Steel pressfitting with seal ring HNBR, yellow, gas, may only be **combined** with the Geberit Mapress Stainless Steel system pipe 1.4401 made of CrNiMo steel for approval purposes.

Geberit Mapress Stainless Steel pressfitting with seal ring CIIR, black, LABS-free



Outer diameter	15–108 mm
Description	<ul style="list-style-type: none"> • Pressfitting made of austenitic stainless steel 1.4401 • Seal ring CIIR, black • Blue pressing indicator • With no protection plug
Properties	<ul style="list-style-type: none"> • Increased molybdenum content, minimum 2.2 % • LABS-free¹⁾ Packed in the original bag • Leaky if unpressed

1) Free of paint-wetting impairment substances, such as silicone.

Geberit Mapress Stainless Steel pressfitting with seal ring FKM, blue



Outer diameter	15–108 mm
Description	<ul style="list-style-type: none"> • Pressfitting made of austenitic stainless steel 1.4401 • Seal ring FKM, blue • Blue pressing indicator • Anthracite protection plug
Properties	<ul style="list-style-type: none"> • Increased molybdenum content, minimum 2.2 % • LABS-free¹⁾ Packed in the original bag

1) Free of paint-wetting impairment substances, such as silicone.

Fittings

Standard fittings

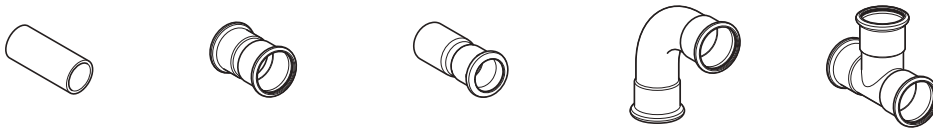

Figure 6: Geberit Mapress Stainless Steel press fittings

Adapters, permanent

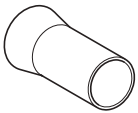

Figure 7: Geberit Mapress Stainless Steel adapter with weld-on and plain end

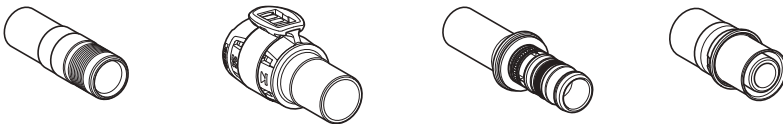

Figure 8: Connections from Geberit PushFit, Geberit FlowFit, Geberit Mepla, Geberit Volex to Geberit Mapress



Figure 9: Geberit Mapress Stainless Steel adapters with male thread and adapters with female thread

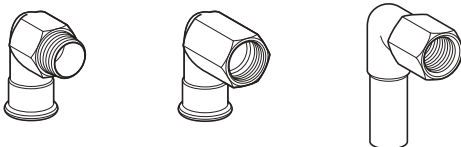

Figure 10: Geberit Mapress Stainless Steel elbow adapter 90°

Adapters and connections, removable

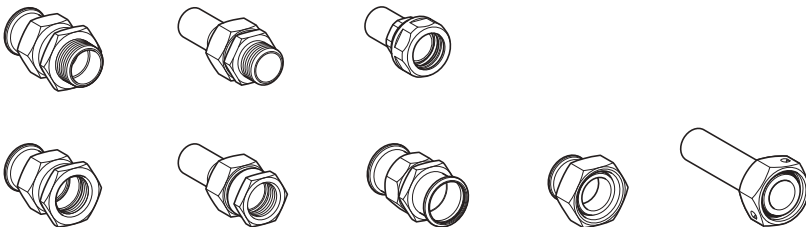

Figure 11: Geberit Mapress Stainless Steel adapters and adapter unions



Figure 12: Geberit Mapress adapters with MasterFix

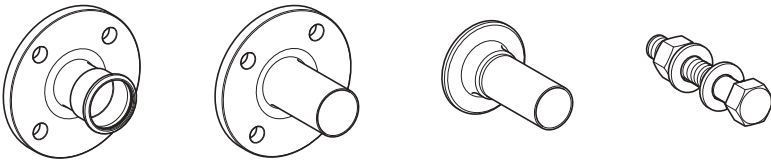

Figure 13: Geberit Mapress Stainless Steel components for flange connections

Catches



Figure 14: Geberit Mapress Stainless Steel cap

Axial expansion fitting, feed-through

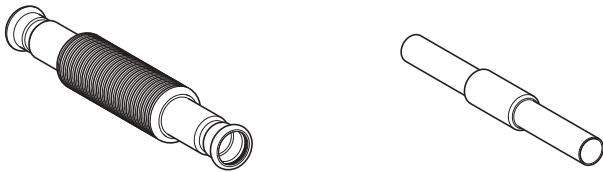

Figure 15: Geberit Mapress Stainless Steel axial expansion fitting and ceiling feed-through

Connections

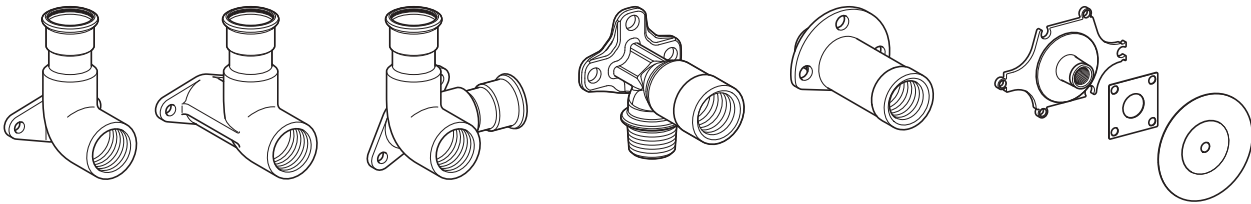

Figure 16: Geberit connections made of stainless steel and gunmetal

Accessories

The following accessories are available for Geberit Mapress Stainless Steel:

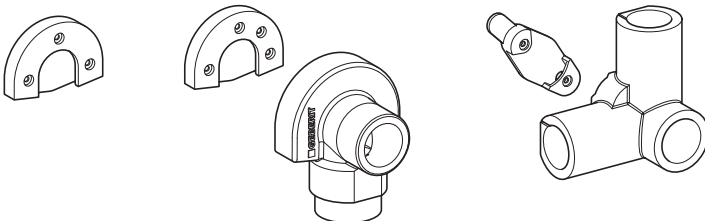

Figure 17: Geberit insulation for connections



Figure 18: Geberit contact protection, as a hose or adhesive tape, yellow

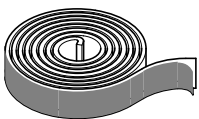

Figure 19: Geberit sealing tape



Figure 20: Geberit Mapress seal rings



Figure 21: Geberit Mapress flat gaskets and flange gasket

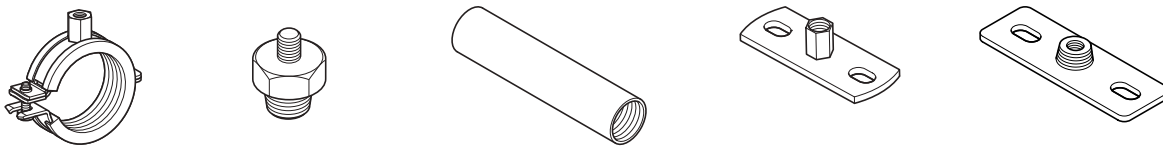

Figure 22: Geberit pipe fastenings

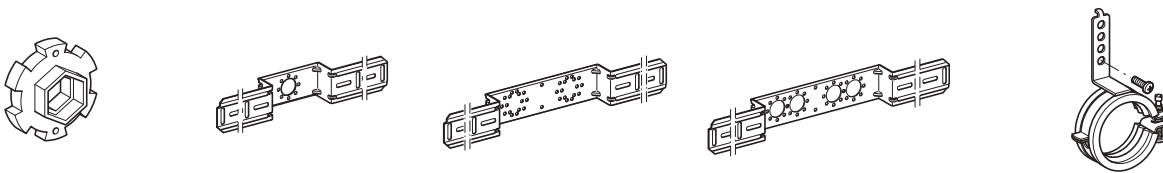

Figure 23: Geberit fastenings for connections

Pipe valve fittings

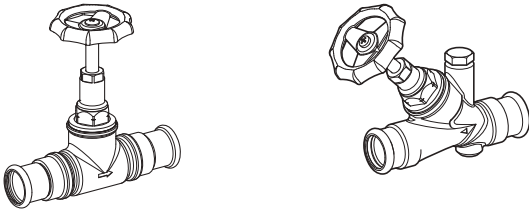

Figure 24: Geberit Mapress stop valves

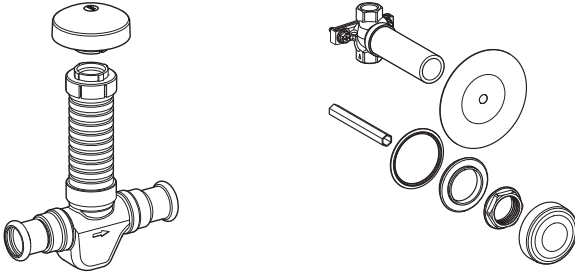

Figure 25: Geberit Mapress concealed stop valves



Figure 26: Geberit Mapress ball valves

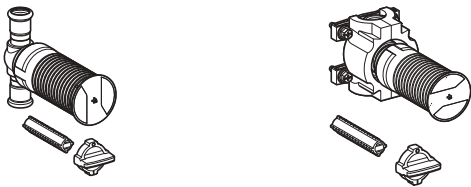

Figure 27: Geberit Mapress concealed ball valves



Figure 28: Geberit Mapress Stainless Steel non-return valve, flanged

Further information on the different designs and applications as well as on various accessories such as actuator levers, handles and spindle extensions can be found in the online or printed catalogue.

Tools





The following processing tools are available for Geberit Mapress:

- Geberit Mapress pressing attachments
 - Pressing jaws
 - Pressing collars and adapter jaws
- Geberit Mapress pipe cutter
- Geberit pipe deburrer
- Geberit stripping tool
- Geberit Mapress insertion distance template with marker pen
- Geberit pressing tools

1.2.3 Pipe marking

Marking of Geberit Mapress Stainless Steel system pipe CrNiMo



The marking of Geberit Mapress Stainless Steel system pipes 1.4401 includes the information in the table in the specified order. A pipe with a dimension of d28 mm is used as an example.

	Geberit company logo
Geberit Mapress	Product name
191025-II	Manufacturing date (25.10.2019, afternoon shift)
x	Manufacturer's mark as agreed
325420	Melt number according to 3.1 Acceptance test certificate
28 x 1.2	Outer pipe diameter and wall thickness [mm]
1.4401/316	Material number EN/AISI
MPA NRW	Inspection authority
DVGW DW xxxXATxxxx	Drinking water approval marks for Germany
67-1802 ATEC xx/xx-xxxx	Approval marks for France
KIWA Kxxxx	Approval marks for the Netherlands
ATG xxxx	Approval marks for Belgium
SITAC xxxx xxxx/xx	Approval marks for Sweden
ÖVGW W xxxx	Approval marks for Austria
 WM-xxxxx ATS xxxx.xxx	Approval marks for Australia
DVGW DG xxxxBLxxxx GAS	Gas approval marks for Germany
TÜV.A. xxx-xx	VdTÜV component marking for Germany
	FM mark (USA approval, d22–108)
VdS G xxxxxxxx	Sprinkler approval marks for Germany
LPCB	Approval marks for the United Kingdom
	CE marking

x Variable content

Marking of Geberit Mapress Stainless Steel system pipe CrMoTi

The marking of Geberit Mapress Stainless Steel system pipes 1.4521 includes the information in the table in the specified order. A pipe with a dimension of d28 mm is used as an example:

	Company logo
Geberit Mapress	Product name
191025-II	Manufacturing date and shift (25.10.2019, afternoon shift)
x	Manufacturer's mark as agreed
325420	Melt number according to 3.1 Acceptance test certificate
28 x 1.2	Outer pipe diameter and wall thickness [mm]
1.4521/444	Material number EN/AISI
MPA NRW	Inspection authority
DVGW DW xxxxATxxxx	Approval marks for Germany
ATG xxxx	Approval marks for Belgium
ÖVGW W xxxx	Approval marks for Austria
SVGW xxxx-xxxx	Approval marks for Switzerland
	CE marking

x Variable content

Marking of Geberit Mapress Stainless Steel system pipe CrNi

The marking of Geberit Mapress Stainless Steel system pipes 1.4301 includes the information in the table in the specified order. A pipe with a dimension of d28 mm is used as an example.

	Company logo
Geberit Mapress	Product name
191025-I	Manufacturing date and shift (25.10.2019, early shift)
Zxx	Manufacturer's mark as agreed
325420	Melt number according to 3.1 Acceptance test certificate
28 x 1.2	Outer pipe diameter and wall thickness [mm]
1.4301/304	Material number EN/AISI
CE	CE marking
ATG xxxx	Approval marks for Belgium

x Variable content

1.2.4 Application examples for fittings

Geberit Mapress Stainless Steel adapters, permanent

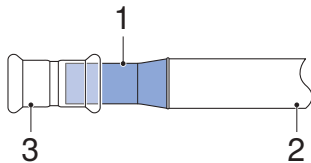

Figure 29: Weld-on adapter

- 1 Geberit Mapress Stainless Steel adapter with weld-on and plain end
- 2 Steel pipe, non-alloy
- 3 Geberit Mapress Stainless Steel pressfitting (threaded socket)

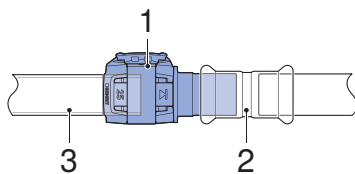

Figure 30: Geberit FlowFit adapter to Geberit Mapress, with plain end

- 1 Geberit FlowFit adapter to Geberit Mapress, with plain end
- 2 Geberit Mapress system pipe
- 3 Geberit system pipe ML or system pipe PB

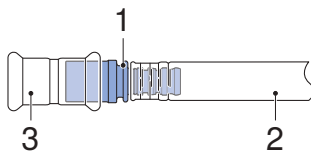

Figure 31: Connection to Geberit Mepla

- 1 Geberit Mepla adapter to Geberit Mapress, with plain end
- 2 Geberit Mepla system pipe
- 3 Geberit Mapress Stainless Steel pressfitting (threaded socket)

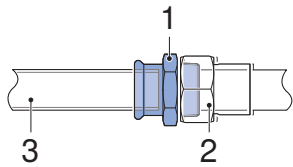

Figure 32: Connection to female thread

- 1 Geberit Mapress Stainless Steel adapter with male thread
- 2 Threaded socket with female thread
- 3 Geberit Mapress Stainless Steel system pipe

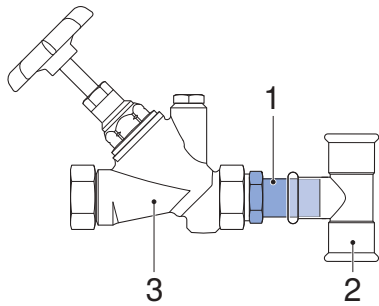

Figure 33: Connection to stop valve

- 1 Geberit Mapress Stainless Steel adapter with male thread and plain end
- 2 Geberit Mapress Stainless Steel pressfitting (T-piece)
- 3 Angle-seat valve

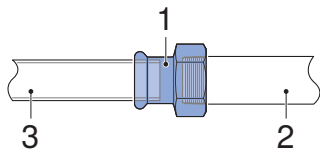

Figure 34: Connection to male thread

- 1 Geberit Mapress Stainless Steel adapter with female thread
- 2 Steel pipe with male thread
- 3 Geberit Mapress Stainless Steel system pipe

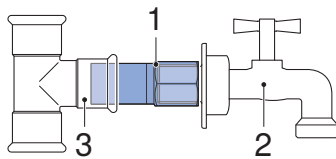

Figure 35: Connection to outside tap

- 1 Geberit Mapress Stainless Steel adapter with female thread and plain end
- 2 Outside tap with male thread
- 3 Geberit Mapress Stainless Steel pressfitting (T-piece)

Geberit Mapress Stainless Steel adapters and connections, removable

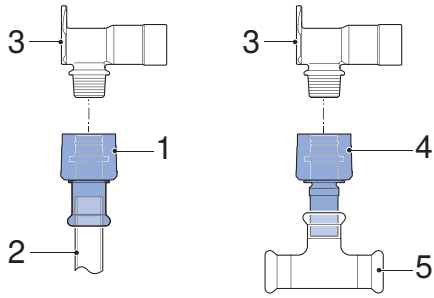

Figure 36: Tool-free connection with MasterFix

- 1 Geberit Mapress adapter with MasterFix
- 2 Geberit Mapress Stainless Steel system pipe
- 3 Geberit fitting with male thread MF 1/2" (elbow tap connector 90°)
- 4 Geberit Mapress adapter with MasterFix and plain end
- 5 Geberit Mapress Stainless Steel pressfitting (T-piece)

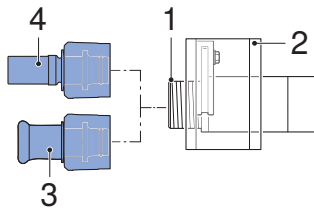

Figure 37: Tap connector, straight, with MasterFix

- 1 Geberit tap connector, straight, with male thread MF 1/2"
- 2 Mounting plate, sound insulation set
- 3 Geberit Mapress adapter with MasterFix
- 4 Geberit Mapress adapter with MasterFix and plain end

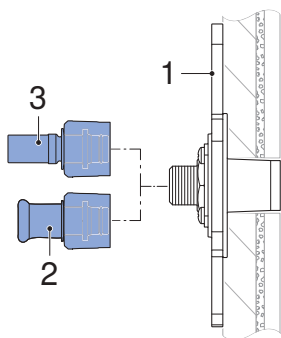

Figure 38: Tap connector, straight, with MasterFix, drywall construction

- 1 Geberit tap connector set, straight, with male thread MF 1/2", premounted, drywall construction
- 2 Geberit Mapress adapter with MasterFix
- 3 Geberit Mapress adapter with MasterFix and plain end

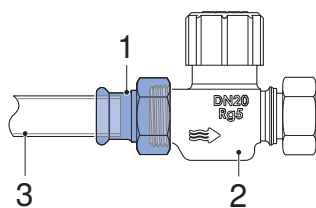

Figure 39: Connection to male thread

- 1 Geberit Mapress Stainless Steel adapter with union nut
- 2 Pipe valve fitting with male thread G
- 3 Geberit Mapress Stainless Steel system pipe

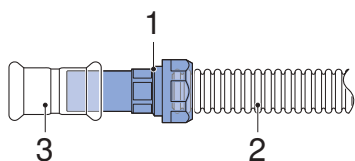

Figure 40: Connection to corrugated pipes

- 1 Geberit Mapress adapter union with clamping ring for corrugated pipes, non-potable water, plain end
- 2 Corrugated pipe
- 3 Geberit Mapress Stainless Steel pressfitting (threaded socket)

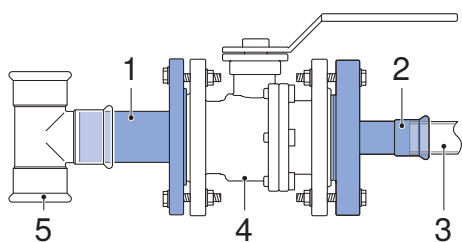

Figure 41: Connection to flange valves

- 1 Geberit Mapress Stainless Steel flange with plain end. Accessories: Geberit flange gasket and screws for flange connection
- 2 Geberit Mapress Stainless Steel flange with pressing socket. Accessories: Geberit flange gasket and screws for flange connection
- 3 Geberit Mapress Stainless Steel system pipe
- 4 Flange valve
- 5 Geberit Mapress Stainless Steel pressfitting (T-piece)

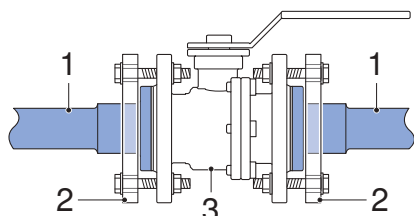

Figure 42: Connection to Geberit Mapress Stainless Steel with flanges

- 1 Geberit Mapress Stainless Steel flanged stub with plain end for loose flange Accessories: Geberit flange gasket, screws for flange connection
- 2 Loose flange according to EN 1092-1, flange type 02
- 3 Flange valve

Geberit Mapress Stainless Steel adapters and connections (gas)

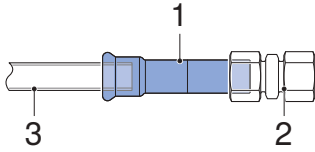

Figure 43: Adapter to cutting ring connection

- 1 Geberit Mapress Stainless Steel adapter to cutting ring connection (gas)
- 2 Cutting ring connection
- 3 Geberit Mapress Stainless Steel system pipe

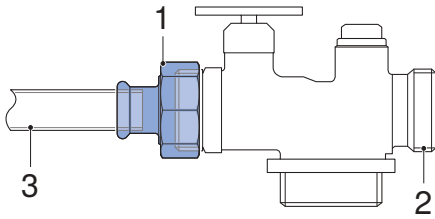

Figure 44: Connection to gas valves, conical-sealing

- 1 Geberit Mapress Stainless Steel adapter with union nut made of CrNi steel (gas)
- 2 Gas meter
- 3 Geberit Mapress Stainless Steel system pipe

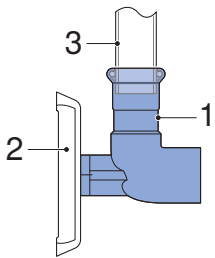











Figure 45: Connection for two-pipe gas meter

- 1 Geberit Mapress Stainless Steel elbow tap connector 90°, offset, circular hole 50 mm (gas)
- 2 Mounting bracket for gas meter
- 3 Geberit Mapress Stainless Steel system pipe

1.2.5 System characteristics

The following table gives an overview of the most important system characteristics of Geberit Mapress Stainless Steel:

Characteristic		Meaning
Diffusion barrier		Geberit Mapress Stainless Steel fittings, pipes and pressed joints form a barrier against diffusion.
Hot water resistance		Permanent 0–100 °C, saturated steam up to a maximum of 120 °C
Resistance to cold		Down to -30 °C under the condition that the medium in the pipe does not freeze
Material abrasion		If the recommended flow rate is observed, no material abrasion occurs in the pipe.
UV resistance		UV-resistant and therefore also suitable for outdoor use.
Corrosion resistance		Geberit Mapress Stainless Steel is largely resistant to corrosion in normal, dry environments as well as to a wide range of liquid and gaseous media. Corrosion protection is required in aggressive environments.
Electrical conductivity		Electrically conductive, must be integrated into the main equipotential bonding.
Transmission of structure-borne sound		In the case of decoupling from the building structure, there is no transmission of structure-borne sound.
Fire behaviour		Geberit metal pipes are non-combustible.

1.2.6 Certificates for Geberit Mapress Stainless Steel

The Geberit Mapress Stainless Steel systems have certificates from the following bodies, amongst others.

Certification body	Application
DVGW	Drinking water installations, gas installations
ÖVGW	
SVGW	
BSI	
CSTB	Drinking water installations
KIWA-NL	
WRAS	
VdS	Sprinkler systems
FM approvals	
BRE LPCB	
TÜV	TÜV component certificate with a supplementary expert report for industrial applications
DIBt	Industrial applications
ABS	Shipbuilding
BV	
CCS	
RINA	
RMRS	

1.2.7 Technical data

Geberit Mapress Stainless Steel system pipe CrNiMo

Product material and product material characteristics



Table 4: Material

Material designation	Austenitic stainless steel CrNiMo (chromium-nickel-molybdenum)	
Short name according to EN 10088	X5CrNiMo17-12-2	
Material number EN	1.4401	
Material number AISI	316	

Table 5: Physical characteristics

Thermal expansion coefficient α at 20–100 °C	0.0165 mm/(m·K)	
Thermal conductivity λ at 20 °C	15 W/(m·K)	
Specific thermal capacity c at 20 °C	500 J/(kg·K)	
Surface roughness k	1.5 μ m	
Building material class	13501	A1
	DIN 4102 Part 1	A1

Table 6: Mechanical characteristics

Heat treatment	Annealed (all pipe dimensions)	
Tensile strength R_m	510–710 N/mm ²	
0.2% expansion limit $R_{p0.2}$	≥ 220 N/mm ²	
Elongation at break A_5	> 40 %	

Pipe data

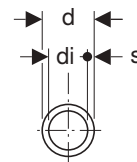
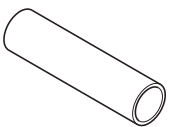

Table 7: Geberit Mapress Stainless Steel system pipe 1.4401

DN	d [mm]	s [mm]	di [mm]	m_R [kg/m]	m_{RW} [kg/m]	V [l/m]
10	12	1	10	0.276	0.355	0.079
12	15	1	13	0.351	0.484	0.133
15	18	1	16	0.426	0.627	0.201
20	22	1.2	19.6	0.626	0.928	0.302
25	28	1.2	25.6	0.806	1.321	0.515
32	35	1.5	32	1.260	2.064	0.804
40	42	1.5	39	1.523	2.718	1.195
50	54	1.5	51	1.974	4.017	2.043
65	76.1	2	72.1	3.715	7.798	4.083
80	88.9	2	84.9	4.357	10.018	5.661
100	108	2	104	5.315	13.810	8.495

m_R Pipe weight

m_{RW} Pipe weight with water at 10 °C

V Pipe volume

Geberit Mapress Stainless Steel system pipe CrMoTi

Product material and product material characteristics



Table 8: Material

Material designation	Ferritic stainless steel CrMoTi (chromium-molybdenum-titanium)
Short name according to EN 10088	X2CrMoTi 18-2
Material number EN	1.4521
Material number AISI	444

Table 9: Physical characteristics

Thermal expansion coefficient α at 20–100 °C	0.0104 mm/(m·K)	
Thermal conductivity λ at 20 °C	23 W/(m·K)	
Specific thermal capacity c at 20 °C	430 J/(kg·K)	
Surface roughness k	1.5 μ m	
Building material class	EN 13501	A1
	DIN 4102 Part 1	A1

Table 10: Mechanical characteristics

Heat treatment	Annealed (only d15–22 mm)
Tensile strength R_m	≥ 400 N/mm ²
0.2% expansion limit $R_{p0.2}$	≥ 280 N/mm ²
Elongation at break A_5	> 20 %

Pipe data

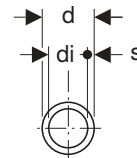
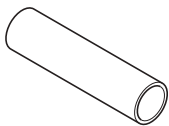

Table 11: Geberit Mapress Stainless Steel system pipe 1.4521

DN	d [mm]	s [mm]	di [mm]	m_R [kg/m]	m_{RW} [kg/m]	V [l/m]
10	12	1	10	0.266	0.345	0.079
12	15	1	13	0.339	0.472	0.133
15	18	1	16	0.411	0.612	0.201
20	22	1.2	19.6	0.604	0.906	0.302
25	28	1.2	25.6	0.778	1.293	0.515
32	35	1.5	32	1.216	2.202	0.804
40	42	1.5	39	1.470	2.665	1.195
50	54	1.5	51	1.905	3.948	2.043

m_R Pipe weight

m_{RW} Pipe weight with water at 10 °C

V Pipe volume

Geberit Mapress Stainless Steel system pipe CrNi

Product material and product material characteristics



Table 12: Material

Material designation	Austenitic stainless steel CrNi (chromium-nickel)	
Abbreviation according to EN 10088	X5CrNi18-10	
Material number EN	1.4301	
Material number AISI	304	

Table 13: Physical characteristics

Thermal expansion coefficient α at 20–100 °C	0.016 mm/(m·K)	
Thermal conductivity λ at 20 °C	15 W/(m·K)	
Specific thermal capacity c at 20 °C	500 J/(kg·K)	
Surface roughness k	1.5 μ m	
Building material class	EN 13501	A1
	DIN 4102 Part 1	A1

Table 14: Mechanical characteristics

Heat treatment condition	Annealed (only d15–22 mm)
Tensile strength R_m	500–700 N/mm ²
0.2% expansion limit $R_{p0.2}$	≥ 220 N/mm ²
Elongation at break A_5	> 40 %

Pipe data

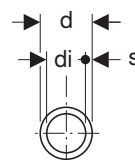
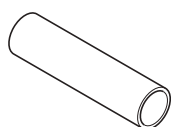

Table 15: Geberit Mapress Stainless Steel system pipe 1.4301

DN	d [mm]	s [mm]	di [mm]	m_R [kg/m]	m_{RW} [kg/m]	V [l/m]
12	15	1	13	0.348	0.481	0.133
15	18	1	16	0.422	0.623	0.201
20	22	1.2	19.6	0.620	0.922	0.302
25	28	1.2	25.6	0.798	1.313	0.515
32	35	1.5	32	1.247	2.051	0.804
40	42	1.5	39	1.508	2.703	1.195
50	54	1.5	51	1.955	3.998	2.043
65	76.1	1.5	73.1	2.777	6.860	4.083
80	88.9	1.5	85.9	3.254	8.915	5.661
100	108	2	104	5.262	13.757	8.495

m_R Pipe weight

m_{RW} Pipe weight with water at 10 °C

V Pipe volume

Pressfittings

Product material and product material characteristics



Table 16: Material of Geberit Mapress Stainless Steel pressfitting

Material designation	Austenitic stainless steel CrNiMo (chromium-nickel-molybdenum)
Short name according to EN 10088	X5CrNiMo17-12-2
Material number EN	1.4401
Material number AISI	316

For information on the recycling code of the pressing indicator and protection plug, see the 'Disposal' chapter.

Table 17: Physical properties of Geberit Mapress Stainless Steel pressfitting

Thermal expansion coefficient α at 20–100 °C	0.0165 mm/(m·K)
Thermal conductivity λ at 20 °C	15 W/(m·K)
Specific thermal capacity c at 20 °C	500 J/(kg·K)
Surface roughness k	1.5 μ m
Building material class	A1 according to EN 13501
	A1 according to DIN 4102 Part 1





Table 18: Mechanical characteristics of Geberit Mapress Stainless Steel pressfitting

Heat treatment	Annealed (all pipe dimensions)
Tensile strength R_m	510–710 N/mm ²
0.2% expansion limit $R_{p0.2}$	\geq 220 N/mm ²
Elongation at break A_5	$>$ 40 %

System seals

Material and temperature resistance

Table 19: Geberit Mapress seal rings for Geberit Mapress Stainless Steel





	CIIR, black 	HNBR, yellow 	FKM, blue 	FKM, white 	FPM, red 
d [mm]	12–108	15–108	12–108	15–108	12–108
Material	Chlorinated butyl rubber	Hydrogenated acrylonitrile-butadiene rubber	Fluoro rubber		Fluoro rubber
Operating temperature ¹⁾ [°C]	-30 – +120	-20 – +70	-25 – +140 ²⁾	-25 – +180 ³⁾	5 – 155
Leaky if unpressed	✓	✓	–		–

✓ Applies

– Does not apply



- 1) Additional information on the operating temperatures, together with the uses and operating pressures, is given in the respective usage overviews. The current usage overviews can be found in the online catalogue or in the printed catalogue.
- 2) Use only approved antifreeze agent according to the "Corrosion and antifreeze agent" technical information.
- 3) When used in thermal media (solar): Service life with collector downtime: 200 h/a at 180 °C, 60 h/a at 200 °C, total service life: 500 h at 220 °C.

Table 20: Geberit Mapress flat gaskets for Geberit Mapress Stainless Steel

	EPDM, black 	FPM, green 	Centellen® HD WS 3822 	Centellen® HD WS 3825 
G	1/2 to 2 3/8"	3/4 to 2 3/8"	3/4 to 2 3/8"	1/2 to 3 1/2"
Material	Ethylene propylene diene monomer rubber	Fluoro rubber	Aramid fibres with inorganic reinforcing materials and rubber as a binding material	Aramid fibres with inorganic reinforcing materials and rubber as a binding material
Operating temperature ¹⁾ [°C]	0–100	-30 – +180	-20 – +155	-30 – +150

- 1) Additional information on the operating temperatures, together with the uses and operating pressures, is given in the respective usage overviews. The current usage overviews can be found in the online catalogue or in the printed catalogue.

Table 21: Geberit Mapress flange gasket and O-rings for Geberit Mapress Stainless Steel

	Geberit Mapress flange gasket Centellen® HD WS 3822 	O-rings for Geberit Mapress screw connections, conical-sealing, gas 
Nominal width DN	15–100	–
G	–	7/8, 1 1/8 and 1 3/8"
Material	Aramid fibres with inorganic reinforcing materials and rubber as a binding material	Hydrogenated acrylonitrile-butadiene rubber
Operating temperature [°C]	-30 – +180	-20 – +70

– Does not apply



The operating conditions specified in the relevant approvals, standards and technical regulations must be observed for each application. These may differ from the information in the usage overviews.

Maximum axial load of pressed joint

The following maximum axial loads apply for Geberit Mapress Stainless Steel pressed joints with stainless steel 1.4401 in applications.

Pressing attachment	d [mm]	Maximum axial load [kN]
Pressing jaw with compatibility [2]/[3]	12	1.1
	15	1.4
	18	2.0
	22	1.9
	28	1.9
	35	1.9
Pressing collar with compatibility [2]/[3]/[2XL]	35	3.6
	42	5.2
	54	8.6
	76.1	10.6
	88.9	12.2
	108	19.5
Pressing collar with compatibility [4]	76.1	19.2
	88.9	25.8
	108	27.2

1.3 GEBERIT MAPRESS CARBON STEEL

1.3.1 Overview of Geberit Mapress Carbon Steel

Geberit Mapress Carbon Steel is a supply system with pipes made of zinc-plated non-alloy steel, in which pipes and fittings are pressed to form permanent, technically tight pipes.

Geberit Mapress Carbon Steel is suitable for applications in closed systems (e.g. heating or cooling systems).

The most common uses are listed below for each Geberit Mapress Carbon Steel system. Other applications (media), together with the operating temperatures and operating pressures, are listed in the respective usage overviews.











The current usage overviews can be found in the online catalogue or in the printed catalogue.



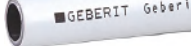





The operating conditions specified in the relevant approvals, standards and technical regulations must be observed for each application. These may differ from the information in the usage overviews.

Geberit Mapress Carbon Steel

Seal ring	Fitting	System pipe	Combined pipe and fitting dimensions	Most common uses
CIIR, black 	Carbon steel 1.0034 	Carbon steel 1.0034, outside zinc-plated 	d12–108 mm	<ul style="list-style-type: none"> • Heating water • Cooling water with and without antifreeze agent • Remote network heating water ≤ 120 °C
CIIR, black 	Carbon steel 1.0034 	Carbon steel 1.0034, plastic-jacketed 	d12–54 mm	<ul style="list-style-type: none"> • Heating water • Cooling water with and without antifreeze agent
CIIR, black 	Carbon steel 1.0034 	Carbon steel 1.0215, inside and outside zinc-plated 	d15–108 mm	<ul style="list-style-type: none"> • Compressed air (oil class 3) • Extinguishing water (wet) • Sprinkler (wet)

Geberit Mapress Carbon Steel, FKM, blue

Seal ring	Fitting	System pipe	Combined pipe and fitting dimensions	Most common uses
<p>FKM, blue</p> 	<p>Carbon steel 1.0034</p> 	<p>Carbon steel 1.0034, outside zinc-plated</p> 	<p>d12–108 mm</p>	<ul style="list-style-type: none"> • Remote network heating water ≤ 140 °C • Thermal medium (solar) • Mineral and lubricating oils • Motor fuels (e.g. diesel)
<p>FKM, blue</p> 	<p>Carbon steel 1.0034</p> 	<p>Carbon steel 1.0215, inside and outside zinc-plated</p> 	<p>d15–108 mm</p>	<ul style="list-style-type: none"> • Compressed air (oil class 3–X)

1.3.2 System components

The Geberit Mapress Carbon Steel system consists of the following components:

- system pipes
- fittings with system seals
- pipe valve fittings
- accessories
- tools

System pipes

Geberit Mapress Carbon Steel 1.0034 system pipe, outside zinc-plated



Outer diameter	12–108 mm
Description	<ul style="list-style-type: none"> • Welded, thin-walled precision steel pipe made of non-alloy steel 1.0034 E 195 (EN 10305) • With red lettering
Properties	<ul style="list-style-type: none"> • Outside zinc-plated with an 8 µm thick protective coating (FeZn8B, chromatised) • Bendable from d12–108 mm¹⁾

1) Can be bent by hand up to a pipe diameter of d28 mm. Special pipe bending machines are required for bending from a diameter of d35 mm.

Geberit Mapress Carbon Steel 1.0034 system pipe, plastic-jacketed



Outer diameter	12–54 mm
Description	<ul style="list-style-type: none"> • Welded, thin-walled precision steel pipe made of non-alloy steel 1.0034/E 220 (EN 10305), with plastic jacketing made of polypropylene (PP), cream white (RAL 9001)
Properties	<ul style="list-style-type: none"> • Outside zinc-plated with an 8 µm thick protective coating (FeZn8B, chromatised) • Plastic jacket can only be used down to -10 °C • Limited bending by hand up to and including d18 mm

i Geberit Mapress system pipes (plastic-jacketed) should not be bent as this can damage the jacketing (over-expansion, delamination).

Geberit Mapress Carbon Steel 1.0215 system pipe, inside and outside zinc-plated



Outer diameter	15–108 mm
Description	<ul style="list-style-type: none"> • Welded, thin-walled precision steel pipe made of non-alloy steel 1.0215 E 220 (EN 10305) • With black lettering
Properties	<ul style="list-style-type: none"> • Sendzimir galvanised on the inside and outside with a 20 µm thick zinc coating. With a VDS certificate for wet sprinkler systems and compressed air systems • Bendable from d15–108 mm¹⁾

1) Can be bent by hand up to a pipe diameter of d28 mm. Special pipe bending machines are required for bending from a diameter of d35 mm.

Pressfittings

Geberit Mapress Carbon Steel pressfitting with seal ring CIIR, black



Outer diameter	12–108mm
Description	<ul style="list-style-type: none"> • Pressfitting made of non-alloy steel 1.0034 E195 (EN 10305), for pressing the Mapress Carbon Steel system pipes for standard applications, e.g. heating installations • Transparent protection plug • Red pressing indicator • Seal ring CIIR, black
Properties	<ul style="list-style-type: none"> • Outside zinc-plated with an 8 µm thick protective coating (FeZn8B, chromatised) • Leaky if unpressed

Geberit Mapress Carbon Steel pressfittings with seal ring FKM, blue



Outer diameter	15–108mm
Description	<ul style="list-style-type: none"> • Standard pressfitting made of non-alloy steel 1.0034 (EN 10305), outside zinc-plated, for industrial and solar applications • Anthracite protection plug • Red pressing indicator • Seal ring FKM, blue

Fittings

Standard fittings

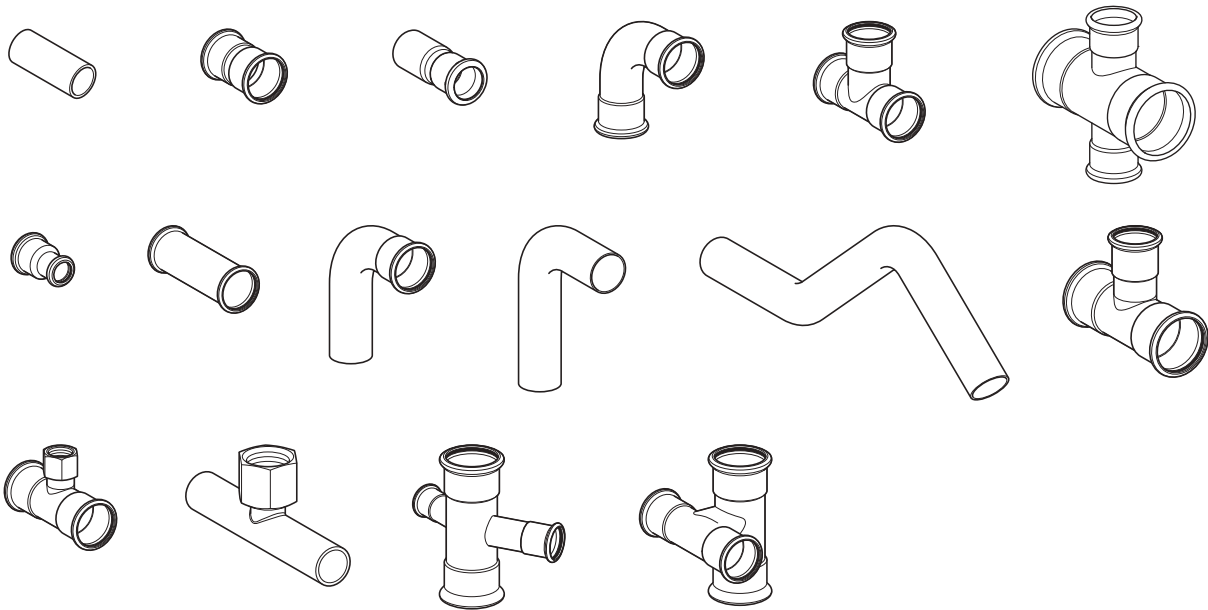

Figure 46: Geberit Mapress Carbon Steel standard fittings

Adapters, permanent

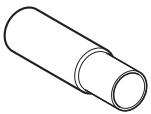

Figure 47: Geberit Mapress Carbon Steel adapter with weld-on and plain end



Figure 48: Connections from Geberit PushFit, Geberit FlowFit, Geberit Mepla, Geberit Volex to Geberit Mapress



Figure 49: Geberit Mapress Carbon Steel adapters with male thread and adapters with female thread

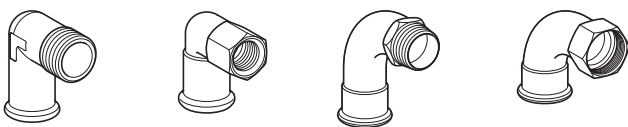

Figure 50: Geberit Mapress Carbon Steel elbow adapters 90° and bend adapters 90°

Adapters and connections, removable



Figure 51: Geberit Mapress Carbon Steel adapters and adapter unions

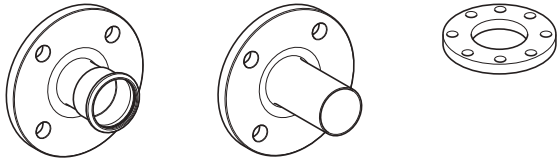

Figure 52: Flange connections

Catches



Figure 53: Geberit Mapress Carbon Steel cap

Axial expansion fitting

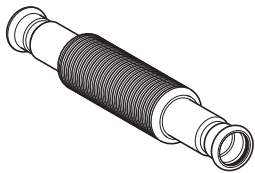

Figure 54: Geberit Mapress Carbon Steel axial expansion fitting

Connections for heating

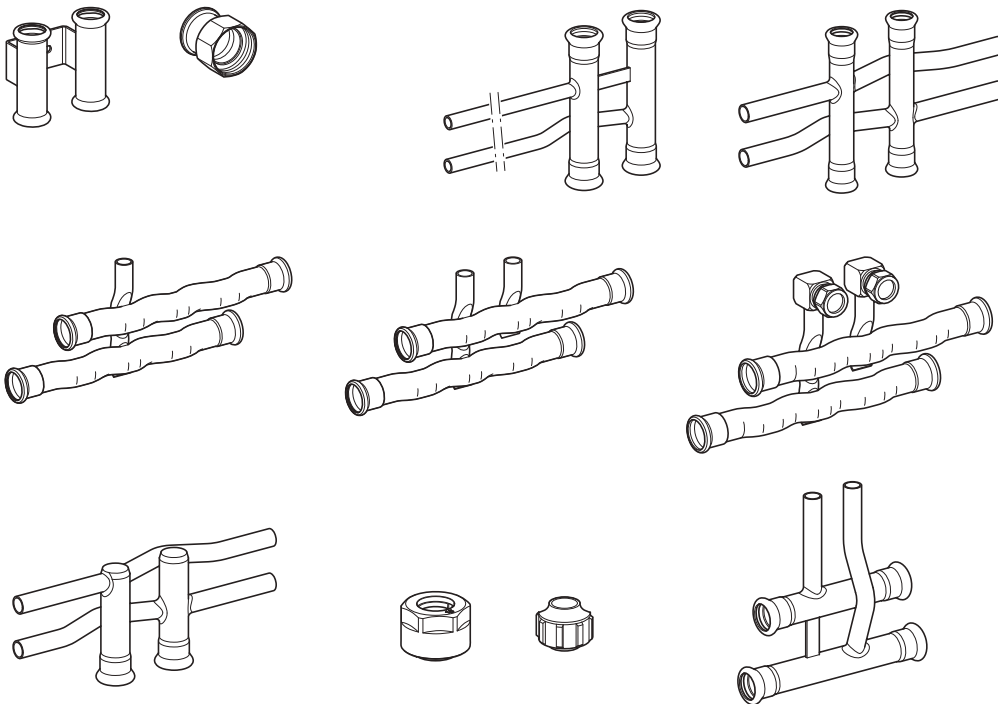

Figure 55: Geberit connections made of stainless steel and gunmetal

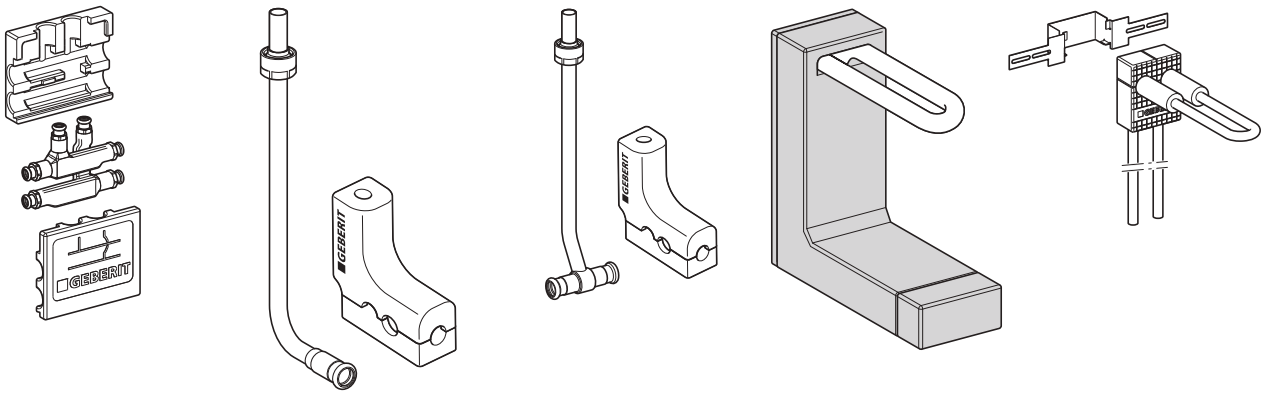

Figure 56: Geberit connector boxes



Figure 57: Geberit Mapress Carbon Steel venturi nozzle for single-pipe heating

Accessories

The following accessories are available for Geberit Mapress Carbon Steel:

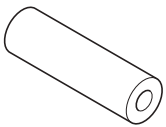

Figure 58: Geberit insulation hose

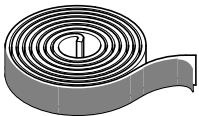

Figure 59: Geberit sealing tape



Figure 60: Covers for pipes

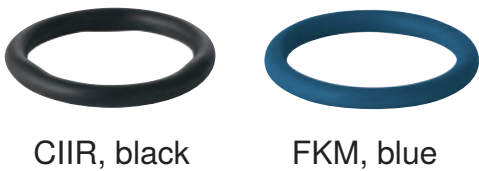

Figure 61: Geberit Mapress seal rings



Figure 62: Geberit Mapress flat gaskets and flange gasket

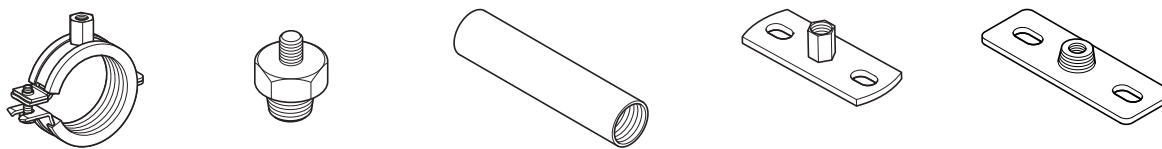

Figure 63: Geberit pipe fastenings

Pipe valve fittings

The following pipe valve fittings are available for Geberit Mapress Carbon Steel:

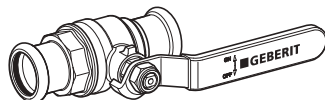

Figure 64: Geberit Mapress ball valve, non-potable water

Further information on the different designs and applications as well as on various accessories such as actuator levers, handles and spindle extensions can be found in the online or printed catalogue.

Tools

The following processing tools are available for Geberit Mapress:

- Geberit Mapress pressing attachments
 - Pressing jaws
 - Pressing collars and adapter jaws
- Geberit Mapress pipe cutter
- Geberit pipe deburrer
- Geberit stripping tool
- Geberit Mapress insertion distance template with marker pen
- Geberit pressing tools

1.3.3 Pipe marking

Marking of Geberit Mapress Carbon Steel system pipe 1.0034

The marking of Geberit Mapress Carbon Steel system pipes 1.0034 includes the information in the table in the specified order. A pipe with a dimension of d28 mm is used as an example.

■ GEBERIT	Company logo
Geberit Mapress	Product name
130222-II	Manufacturing date and shift (22.02.2013, afternoon shift)
Zxx	Manufacturer's mark as agreed
28 x 1.5	Pipe dimension [mm] (pipe diameter x wall thickness)
1.0034 / 1009	Material number EN / AISI
67-1802 ATEC xx/xx-xxxx	Approval marks for France
ATG xxxx	Approval marks for Belgium
NPW	Non-potable water (non-potable water)

Marking of Geberit Mapress Carbon Steel system pipe 1.0215

The marking of Geberit Mapress Carbon Steel system pipes 1.0215 includes the information in the table in the specified order. A pipe with a dimension of d54 mm is used as an example.

	Company logo
Geberit Mapress	Product name
080201-II	Manufacturing date and shift (01.02.2008, afternoon shift)
Zxx	Manufacturer's mark as agreed
54 x 1.5	Outer pipe diameter and wall thickness [mm]
1.0215/1009	Material number EN/AISI
VdS G 4030020	Sprinkler approval mark for Germany d22–54
VdS G 4070025	Sprinkler approval mark for Germany d76,1–108

1.3.4 Application examples for fittings

Geberit Mapress Carbon Steel adapters, permanent

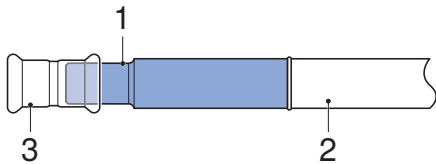

Figure 65: Weld-on adapter

- 1 Geberit Mapress Carbon Steel adapter with weld-on and plain end
- 2 Steel pipe, non-alloy
- 3 Geberit Mapress Carbon Steel pressfitting (threaded socket)

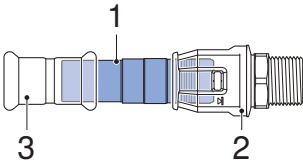

Figure 66: Connection to Geberit PushFit

- 1 Geberit PushFit connection to Geberit Mapress plain and push-fit end
- 2 Geberit PushFit push-fit fitting
- 3 Geberit Mapress Carbon Steel pressfitting (threaded socket)

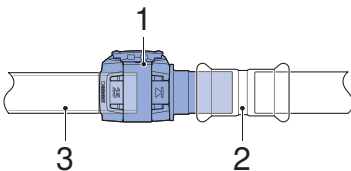

Figure 67: Connection to Geberit FlowFit

- 1 Geberit FlowFit adapter to Geberit Mapress, with plain end
- 2 Geberit Mapress Carbon Steel pressfitting (threaded socket)
- 3 Geberit system pipe ML or Geberit system pipe PB

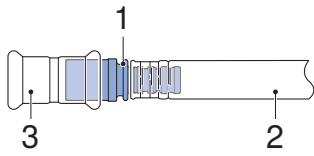

Figure 68: Connection to Geberit Mepla

- 1 Geberit Mepla adapter to Geberit Mapress, with plain end
- 2 Geberit Mepla system pipe
- 3 Geberit Mapress pressfitting (threaded socket)

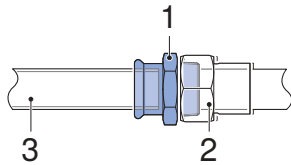

Figure 69: Connection to female thread

- 1 Geberit Mapress Carbon Steel adapter with male thread
- 2 Threaded socket with female thread
- 3 Geberit Mapress Carbon Steel system pipe

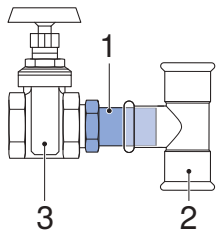

Figure 70: Connection to stop valve

- 1 Geberit Mapress Carbon Steel adapter with male thread and plain end
- 2 Geberit Mapress Carbon Steel pressfitting (T-piece)
- 3 Slide valves

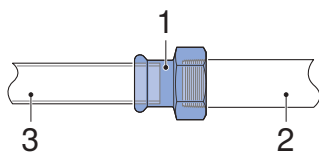

Figure 71: Connection to male thread

- 1 Geberit Mapress Carbon Steel adapter with female thread
- 2 Steel pipe with male thread
- 3 Geberit Mapress Carbon Steel system pipe

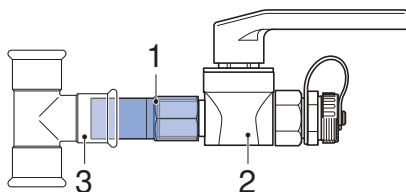

Figure 72: Connection to male thread

- 1 Geberit Mapress Carbon Steel adapter with union nut
- 2 Pipe valve fitting with male thread G (heating fill valve)
- 3 Geberit Mapress Carbon Steel T-piece

Geberit Mapress Carbon Steel adapters and connections, removable

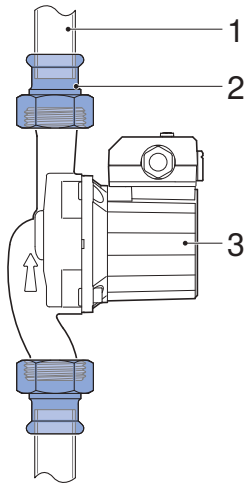

Figure 73: Connection to male thread

- 1 Geberit Mapress Carbon Steel system pipe
- 2 Geberit Mapress Carbon Steel adapter with union nut
- 3 Circulation pump with male thread G

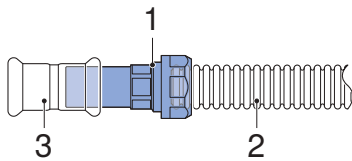

Figure 74: Connection to corrugated pipes

- 1 Geberit Mapress adapter union with clamping ring for corrugated pipes, non-potable water, plain end
- 2 Corrugated pipe
- 3 Geberit Mapress Carbon Steel pressfitting (threaded socket)

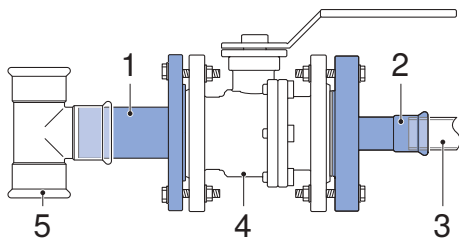

Figure 75: Connection to flange valves

- 1 Geberit Mapress Carbon Steel flange with plain end. Accessories: Flange gasket and screws for Geberit flange connection
- 2 Geberit Mapress Carbon Steel flange with pressing socket. Accessories: Flange gasket and screws for Geberit flange connection
- 3 Geberit Mapress Carbon Steel system pipe
- 4 Flange valve
- 5 Geberit Mapress Carbon Steel pressfitting (T-piece)

Geberit Mapress Carbon Steel heating connections

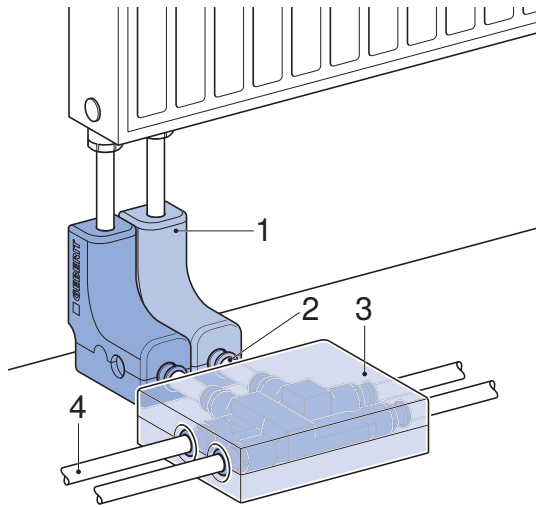

Figure 76: Radiator connection for pipe laying with a distance to the wall

- 1 Geberit Mapress metal pipe connector bend 90° with insulation box and union connector for Euro cone
- 2 Geberit Mapress Carbon Steel pipe nipple, outside zinc-plated
- 3 Geberit Mapress T-piece crossing with insulation box
- 4 Geberit Mapress Carbon Steel system pipe (inlet / return flow)

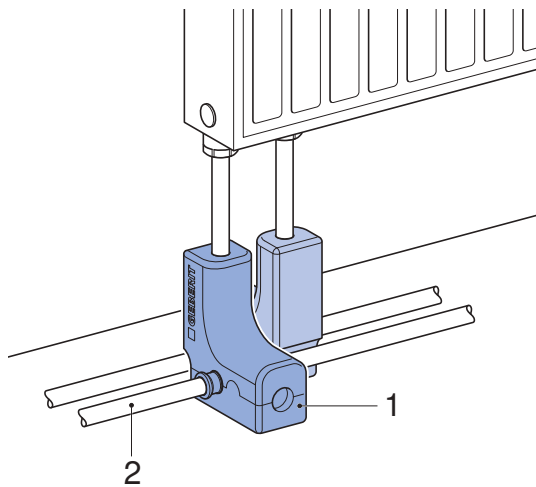

Figure 77: Radiator connection for pipe laying near the wall

- 1 Geberit Mapress metal pipe connection T-piece with insulation box and union connector for Euro cone
- 2 Geberit Mapress Carbon Steel system pipe (inlet / return flow)

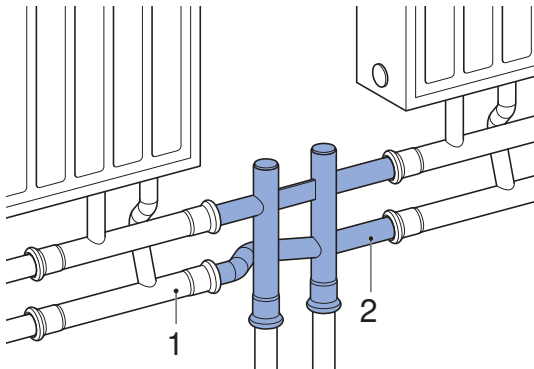

Figure 78: Connection to end piece for riser pipe

- 1 Geberit Mapress Carbon Steel system pipe (inlet / return flow)
- 2 Geberit Mapress Carbon Steel connector end piece for inlet and return flow, long

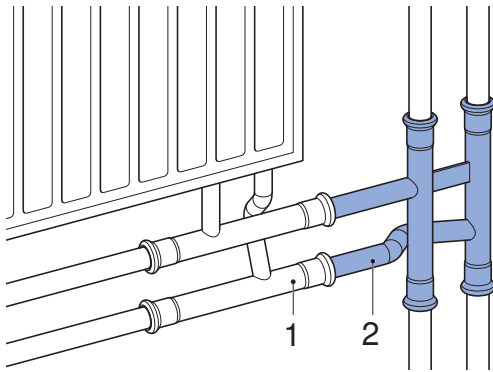

Figure 79: Connection to riser pipe, 1 radiators

- 1 Geberit Mapress Carbon Steel system pipe (inlet / return flow)
- 2 Geberit Mapress Carbon Steel connector T-piece for inlet and return flow, long

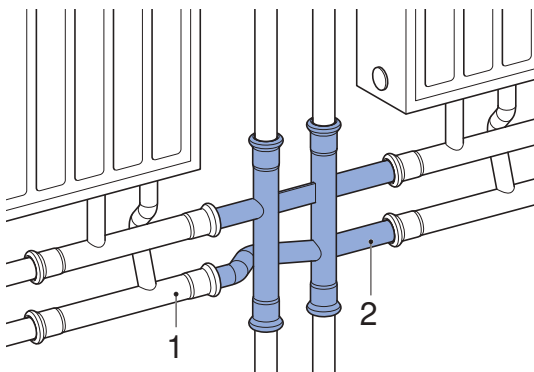

Figure 80: Connection to riser pipe, 2 radiators

- 1 Geberit Mapress Carbon Steel system pipe (inlet / return flow)
- 2 Geberit Mapress Carbon Steel connector pipe cross for inlet and return flow, long

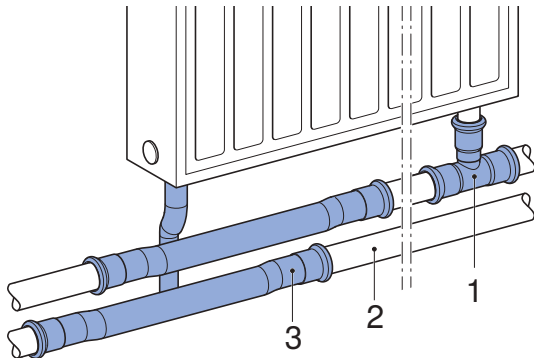

Figure 81: Connection for surface-mounted pipe (skirting board), with a distance between the inlet and return flow

- 1 Geberit Mapress Carbon Steel T-piece, reduced
- 2 Geberit Mapress Carbon Steel system pipe (inlet / return flow)
- 3 Geberit Mapress Carbon Steel connector T-piece set for return flow

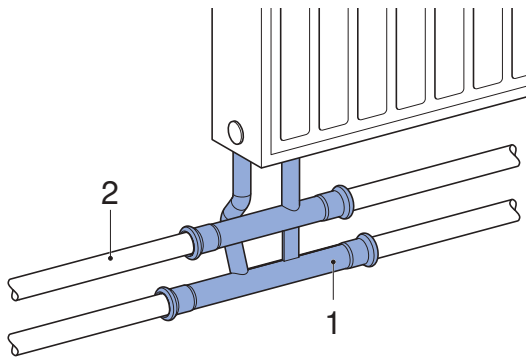

Figure 82: Connection for surface-mounted pipe (skirting board), with connector 4 cm

- 1 Geberit Mapress Carbon Steel connector T-piece for inlet and return flow
- 2 Geberit Mapress Carbon Steel system pipe (inlet / return flow)

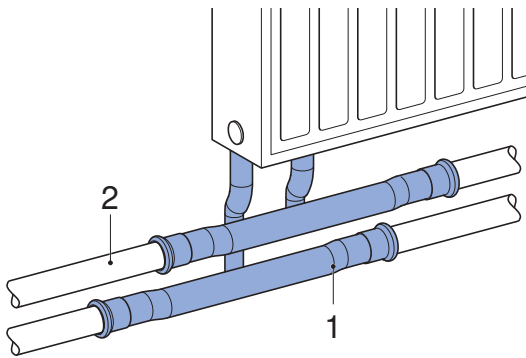

Figure 83: Connection for surface-mounted pipe (skirting board), with extendible connector

- 1 Geberit Mapress Carbon Steel connector T-piece set for inlet and return flow
- 2 Geberit Mapress Carbon Steel system pipe (inlet / return flow)

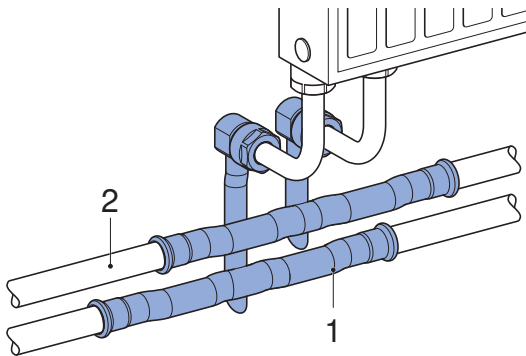

Figure 84: Skirting board connection with adapter with union connector for Euro cone

- 1 Geberit Mapress Carbon Steel connector T-piece set for inlet and return flow, with union connector for Euro cone
- 2 Geberit Mapress Carbon Steel system pipe (inlet / return flow)

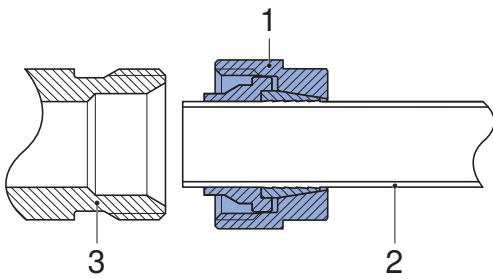

Figure 85: Union connector for Euro cone

- 1 Union connector for Euro cone
- 2 Geberit Mapress system pipe
- 3 Valve tap block with Euro cone

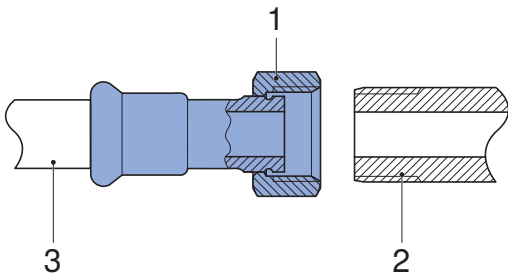

Figure 86: Connector with union nut

- 1 Geberit Mapress Carbon Steel connector with union nut
- 2 Valve tap block with male thread
- 3 Geberit Mapress Carbon Steel system pipe

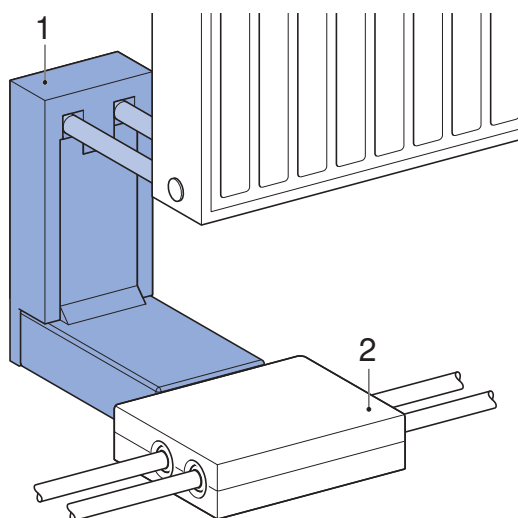

Figure 87: Radiator connector box type C for higher screed constructions

- 1 Geberit Mapress connector box type C
- 2 Geberit Mapress T-piece crossing with insulation box

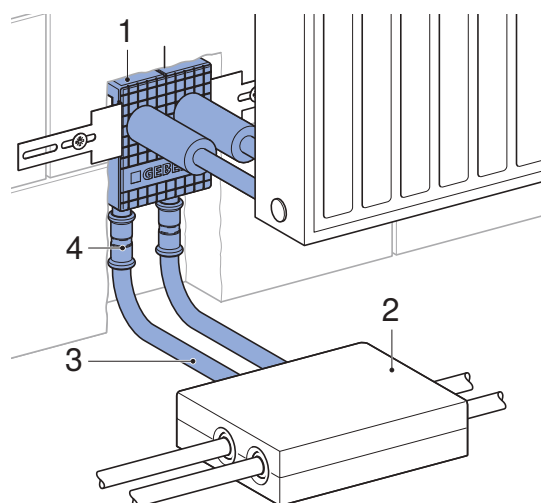











Figure 88: Radiator connector box type L for low screed constructions

- 1 Geberit Mapress connector box type L
- 2 Geberit Mapress T-piece crossing with insulation box
- 3 Geberit Mapress Carbon Steel system pipe
- 4 Geberit Mapress threaded socket

1.3.5 System characteristics

The following table gives an overview of the most important system characteristics of Geberit Mapress Carbon Steel:

Characteristic		Meaning
Diffusion barrier		Geberit Mapress Carbon Steel fittings, pipes and pressed joints form a barrier against diffusion.
Hot water resistance		Permanent 0–100 °C, remote network heating water ≤ 120 °C
Resistance to cold		Down to -30 °C under the condition that the medium in the pipe does not freeze
Material abrasion		If the recommended flow rate is observed, no material abrasion occurs in the pipe.
UV resistance		UV-resistant
Corrosion resistance		Corrosion-resistant in closed systems, in which the oxygenation capacity is excluded, as well as against a variety of liquids and gaseous media. Corrosion protection is required in damp or aggressive environments.
Electrical conductivity		Electrically conductive, must be integrated into the main equipotential bonding.
Transmission of structure-borne sound		In the case of decoupling from the building structure, there is no transmission of structure-borne sound.
Fire behaviour		Geberit metal pipes are non-combustible.

1.3.6 Geberit Mapress Carbon Steel certificates

The Geberit Mapress Carbon Steel systems have certificates from the following bodies, amongst others.

Certification body	Application
TÜV	TÜV component certificate with a supplementary expert report for industrial applications
DiBt	Industrial applications
CSTB	Heating systems
VdS	Sprinkler systems
FM approvals	
BRE LPCB	
ABS	
BV	Shipbuilding
CCS	
DNV	

1.3.7 Technical data

Geberit Mapress Carbon Steel system pipe, outside zinc-plated

Product material and product material characteristics



Table 22: Material

Material designation	Non-alloy steel	
Short designation according to EN 10305	E195	
Material number EN	1.0034	
Material number AISI	1009	
Type of galvanisation	Galvanically zinc-plated, blue passivated	
Layer design (EN 10346:2015-10)	FeZn8	
Layer thickness	8 μm	

Table 23: Physical characteristics

Thermal expansion coefficient α at 20–100 °C	0.012 mm/(m·K)	
Thermal conductivity λ at 20 °C	60 W/(m·K)	
Specific thermal capacity c at 20 °C	500 J/(kg·K)	
Surface roughness k	10 μm	
Building material class	EN 13501	A1
	DIN 4102 Part 1	A1

Table 24: Mechanical characteristics

Tensile strength R_m at $d \leq 22$ mm	290–420 N/mm ²
Tensile strength R_m at $d \geq 28$ mm	310–440 N/mm ²
0.2 % expansion limit $R_{p0.2}$ at $d \leq 22$ mm	> 260 N/mm ²
0.2 % expansion limit $R_{p0.2}$ at $d \leq 28$ mm	> 260–360 N/mm ²
Elongation at break A_5	> 25 %

Pipe data

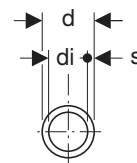
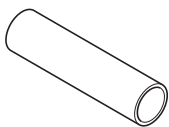

Table 25: Geberit Mapress Carbon Steel system pipe 1.0034 outside zinc-plated

DN	d [mm]	s [mm]	di [mm]	m_R [kg/m]	m_{RW} [kg/m]	V [l/m]
10	12	1.2	9.6	0.320	0.392	0.072
12	15	1.2	12.6	0.408	0.533	0.125
15	18	1.2	15.6	0.497	0.688	0.191
20	22	1.5	19	0.758	1.042	0.284
25	28	1.5	25	0.980	1.471	0.491
32	35	1.5	32	1.239	2.043	0.804
40	42	1.5	39	1.498	2.693	1.195
50	54	1.5	51	1.942	3.985	2.043

DN	d [mm]	s [mm]	di [mm]	m _R [kg/m]	m _{RW} [kg/m]	V [l/m]
65	66.7	1.5	63.7	2.412	5.599	3.187
65	76.1	2	72.1	3.655	7.738	4.083
80	88.9	2	84.9	4.286	9.947	5.661
100	108	2	104	5.228	13.723	8.495

2 / 2

m_R Pipe weight

m_{RW} Pipe weight with water at 10 °C

V Pipe volume

Geberit Mapress Carbon Steel system pipe, plastic-jacketed

Product material and product material characteristics



Table 26: Product material of Geberit Mapress Carbon Steel system pipe, plastic-jacketed

Material designation	Non-alloy steel
Short designation according to EN 10305	E195
Material number EN	1.0034
Material number AISI	1009
Type of galvanisation	Galvanically zinc-plated, blue passivated
Layer design according to EN 10346:2015-10	FeZn8
Layer thickness	8 μm
Material designation of pipe jacketing	PP

Table 27: Physical properties of Geberit Mapress Carbon Steel system pipe

Thermal expansion coefficient α at 20–100 °C	0.012 mm/(m·K)	
Thermal conductivity λ of system pipe at 20 °C	60 W/(m·K)	
Specific thermal capacity c at 20 °C	500 J/(kg·K)	
Surface roughness k	10 μm	
Building material class of carbon steel pipe with jacketing	EN 13501–1	E
	DIN 4102 Part 1	B2, non-combustible, dripping

Table 28: Physical properties of Geberit Mapress Carbon Steel jacketing

Density ρ	0.95 g/cm ³ (non=porous, waterproof)	
Thermal conductivity λ of jacketing at 20 °C	0.22 W/(m·K)	
Maximum operating temperature	120 °C	
Minimum ambient temperature	-10 °C	
UV resistance	Not UV-resistant	
Building material class	E according to EN 13501	
	B2 according to DIN 4102 Part 1	

Table 29: Mechanical characteristics of Geberit Mapress Carbon Steel system pipe, plastic-jacketed

Tensile strength R_m at $d \leq 22$ mm	290–420 N/mm ²
Tensile strength R_m at $d \geq 28$ mm	310–440 N/mm ²
0.2 % expansion limit $R_{p0.2}$ at $d \leq 22$ mm	> 260 N/mm ²
0.2 % expansion limit $R_{p0.2}$ at $d \leq 28$ mm	> 260–360 N/mm ²
Elongation at break A_5	> 25 %

Table 30: Required bending moment of Geberit Mapress Carbon Steel system pipe, plastic-jacketed

d [mm]	s [mm]	F [Nm]
12	1.2	80
15	1.2	100
18	1.2	160

Geberit Mapress Carbon Steel system pipes with plastic jacketing can be processed down to -10 °C.



Geberit Mapress system pipes (plastic-jacketed) should not be bent as this can damage the jacketing (over-expansion, delamination).

Pipe data

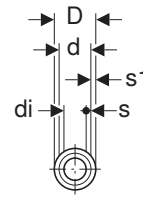
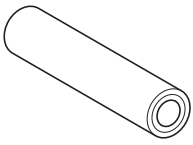

Table 31: Geberit Mapress Carbon Steel system pipe 1.0034, plastic-jacketed

DN	d [mm]	D [cm]	s [mm]	s1 [mm]	di [mm]	m _R [kg/m]	m _{RW} [kg/m]	V [l/m]
10	12	1.4	1.2	0.9	9.6	0.338	0.410	0.072
12	15	1.7	1.2	0.9	12.6	0.434	0.559	0.125
15	18	2	1.2	0.9	15.6	0.536	0.727	0.191
20	22	2.4	1.5	0.9	19	0.824	1.108	0.284
25	28	3	1.5	0.9	25	1.052	1.543	0.491
32	35	3.7	1.5	0.9	32	1.320	2.124	0.804
40	42	4.4	1.5	0.9	39	1.620	2.815	1.195
50	54	5.6	1.5	0.9	51	2.098	4.141	2.043

m_R Pipe weight

m_{RW} Pipe weight with water at 10 °C

V Pipe volume

Geberit Mapress Carbon Steel system pipe, inside and outside zinc-plated

Product material and product material characteristics



Table 32: Product material of Geberit Mapress Carbon Steel system pipe, inside and outside zinc-plated

Material designation	Non-alloy steel
Short designation according to EN 10305	E220
Material number EN	1.0215
Material number AISI	1009
Type of galvanisation	Sendzimir galvanised
Layer design according to EN 10346:2015-10	Z275
Layer thickness	20 μm

Table 33: Physical properties of Geberit Mapress Carbon Steel system pipe, inside and outside zinc-plated

Thermal expansion coefficient α at 20–100 °C	0.012 mm/(m·K)	
Thermal conductivity λ at 20 °C	60 W/(m·K)	
Specific thermal capacity c at 20 °C	500 J/(kg·K)	
Surface roughness k	10 μm	
Building material class	EN 13501	A1
	DIN 4102 Part 1	A1

Table 34: Mechanical characteristics of Geberit Mapress Carbon Steel system pipe, inside and outside zinc-plated

Tensile strength R_m at $d \leq 22$ mm	≥ 310 N/mm ²
Tensile strength R_m at $d \geq 28$ mm	≥ 310 N/mm ²
Expansion limit R_{eH} at $d \leq 22$ mm	—
Expansion limit R_{eH} at $d \leq 28$ mm	≥ 310 N/mm ²
Elongation at break A_5	> 28 %

Pipe data

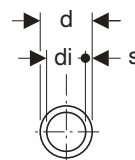
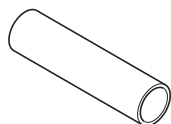

Table 35: Geberit Mapress Carbon Steel inside and outside zinc-plated system pipe

DN	d [mm]	s [mm]	di [mm]	m_R [kg/m]	m_{RW} [kg/m]	V [l/m]
12	15	1.5	12	0.499	0.612	0.113
15	18	1.5	15	0.610	0.787	0.177
20	22	1.5	19	0.758	1.042	0.284
25	28	1.5	25	0.980	1.471	0.491
32	35	1.5	32	1.239	2.043	0.804
40	42	1.5	39	1.498	2.693	1.195
50	54	1.5	51	1.942	3.985	2.043
65	66.7	1.5	63.7	2.412	5.599	3.187
65	76.1	2	72.1	3.655	7.738	4.083
80	88.9	2	84.9	4.286	9.947	5.661
100	108	2	104	5.228	13.723	8.495

m_R Pipe weight

m_{RW} Pipe weight with water at 10 °C

V Pipe volume

Pressfittings

Product material and product material characteristics



Table 36: Material of Geberit Mapress Carbon Steel pressfitting

Material designation	Non-alloy steel
Short name according to DIN EN 10305	E195
Material number EN	1.0034
Material number AISI	1009
Type of galvanisation	Galvanically zinc-plated, blue passivated
Layer design according to DIN EN ISO 2081:2009-05	FeZn8
Layer thickness	8 µm

For information on the recycling code of the pressing indicator and protection plug, see the 'Disposal' chapter.

System seals

Material and temperature resistance

Table 37: Geberit Mapress seal rings for Geberit Mapress Carbon Steel





	CIIR, black	FKM, blue	
		Aqueous media (e.g. remote heating networks)	Thermal medium (solar)
d [mm]	12–108	12–108	
Material	Chlorinated butyl rubber	Fluoro rubber	
Operating temperature ¹⁾ [° C]	-30 – +120	-25 – +140 ²⁾	-25 – +180 ³⁾
Leaky if unpressed	✓	–	

✓ Applies

– Does not apply

- 1) Additional information on the operating temperatures, together with the uses and operating pressures, is given in the respective usage overviews. The current usage overviews can be found in the online catalogue or in the printed catalogue.
- 2) Use only approved antifreeze agent according to the "Corrosion and antifreeze agent" technical information.
- 3) When used in thermal media (solar): Service life with collector downtime: 200 h/a at 180 °C, 60 h/a at 200 °C, total service life: 500 h at 220 °C.

Table 38: Geberit Mapress flat gaskets and flange gasket for Geberit Mapress Carbon Steel

	EPDM, black 	FPM, green 	Centellen® HD WS 3825 	Centellen® HD WS 3822 
Size	G 1/2 to 2 3/8"	G 3/4 to 2 3/8"	1/2 to 3 1/2"	Nominal 15–100
Material	Ethylene propylene diene monomer rubber	Fluoro rubber	Aramid fibres with inorganic reinforcing materials and rubber as a binding material	Aramid fibres with inorganic reinforcing materials and rubber as a binding material
Operating temperature ¹⁾ [° C]	0–100	-30 – +180	-30 – +150	-30 – +180

1) Additional information on the operating temperatures, together with the uses and operating pressures, is given in the respective usage overviews. The current usage overviews can be found in the online catalogue or in the printed catalogue.

Maximum axial load of pressed joint

The following maximum loads apply to Geberit Mapress Carbon Steel pressed joints during use:

Pressing attachment	d [mm]	Maximum axial load [kN]
Pressing jaw with compatibility [2]/[3]	12	1.8
	15	2.1
	18	2.6
	22	1.9
	28	2.1
	35	2.5
Pressing collar with compatibility [2]/[3]/[2XL]	42	7.2
	54	8.0
	66.7	9.5
	76.1	10.4
	88.9	10.8
	108	15.7
Pressing collar with compatibility [4]	76.1	17.4
	88.9	23.8
	108	27.2

1.4 GEBERIT MAPRESS COPPER

1.4.1 Overview of Geberit Mapress Copper

Geberit Mapress Copper is a supply system with pressfittings made of the following materials:

- Copper
- Gunmetal
- Brass

The Geberit Mapress Copper range does not include copper pipes. The fittings in the Geberit Mapress Copper range are approved for pressing copper pipes according to EN 1057:2006+A1:2010 and DVGW GW 392:2015-04.

Due to the wide range of possible combinations of pipes, fittings and seal rings, Geberit Mapress Copper covers many applications in technical building systems, industry and shipbuilding.

The most common uses are listed below for each Geberit Mapress Copper system. Other applications (media), together with the operating temperatures and operating pressures, are listed in the respective usage overviews.





The current usage overviews can be found in the online catalogue or in the printed catalogue.





The operating conditions specified in the relevant approvals, standards and technical regulations must be observed for each application. These may differ from the information in the usage overviews.

Geberit Mapress Copper

Seal ring	Fitting	System pipe	Combined pipe and fitting dimensions	Most common uses
CIIR, black 	Copper 	Copper pipe according to EN 1057:2006+A1:2010	d12–54 mm	<ul style="list-style-type: none"> • Cold and hot drinking water up to 100 °C • Heating water • Cooling water with and without antifreeze agent • Remote network heating water ≤ 120 °C • Service water • Compressed air (oil class 0–3) • Negative pressure • Inert gases (e.g. nitrogen)
EPDM, black 			d66.7–108 mm	

Geberit Mapress Copper, gas

Seal ring	Fitting	System pipe	Combined pipe and fitting dimensions	Most common uses
HBNR, yellow 	Copper 	Copper pipe according to EN 1057:2006+A1:2010	d15–54 mm	<ul style="list-style-type: none"> • Natural gases • Liquefied gases • Biogases

Replacement of the seal ring for additional applications

The seal ring in the pressfitting can be easily replaced depending on the application purpose. The Geberit Mapress Copper pressfitting with the seal ring CIIR, black serves as the basis. Additional applications are therefore possible.

The following seal rings are available for replacement:

Seal ring	System pipe	Combined pipe and seal ring dimensions	Most common uses
FKM, blue 	Copper pipe according to EN 1057:2006+A1:2010	d12–54 mm	<ul style="list-style-type: none"> • Thermal medium (solar) • Mineral and lubricating oils • Motor fuels (e.g. diesel) • Compressed air (oil class 0–X)

1.4.2 System components

In addition to pressfittings made of copper, the Geberit Mapress Copper system includes fittings made of gunmetal and brass. The range consists of the following components:

- fittings with system seals
- pipe valve fittings
- accessories
- tools

Pressfittings

Geberit Mapress Copper pressfitting with seal ring CIIR, black



Outer diameter	12–54 mm
Description	<ul style="list-style-type: none"> • Pressfitting made of CuDHP copper for pressing quality copper pipes according to EN/DVGW, for sanitary and industrial applications • Transparent protection plug • White pressing indicator • Seal ring CIIR, black
Properties	<ul style="list-style-type: none"> • Leaky if unpressed

Geberit Mapress Copper pressfitting with seal ring EPDM, black



Outer diameter	66.7–108mm
Description	<ul style="list-style-type: none"> • Pressfitting made of CuDHP copper for pressing quality copper pipes according to EN/DVGW, for sanitary and industrial applications • Transparent protection plug • White pressing indicator • Seal ring EPDM, black



The seal ring EPDM, black, must be used with Geberit Mapress Copper for diameters larger than 54 mm.

Geberit Mapress Copper pressfitting with seal ring FKM, blue



Outer diameter	15–54mm
Description	<ul style="list-style-type: none"> • Pressfitting made of CuDHP copper, brass or gunmetal, for pressing quality copper pipes according to EN/DVGW, for special applications, e.g. solar applications • Seal ring FKM, blue • White pressing indicator • Black protection plug

Geberit Mapress Copper pressfitting with seal ring HNBR, yellow



Outer diameter	15–54mm
Description	<ul style="list-style-type: none"> • Pressfitting made of CuDHP copper, brass or gunmetal, for pressing quality copper pipes according to EN/DVGW, for gas installations (natural and liquefied gases) • Seal ring HNBRyellow • White pressing indicator • Yellow protection plug
Properties	<ul style="list-style-type: none"> • Leaky if unpressed

Adapters and connections, removable



Figure 94: Geberit Mapress Copper adapters and adapter unions



Figure 95: Geberit Mapress adapters with MasterFix

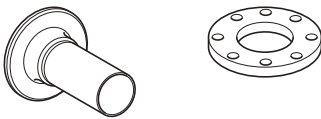

Figure 96: Flange connections

Catches



Figure 97: Geberit Mapress Copper cap

Connections

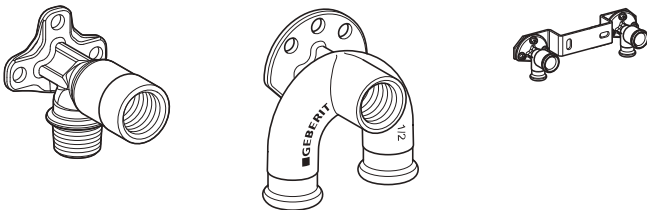

Figure 98: Geberit connections, stainless steel and gunmetal

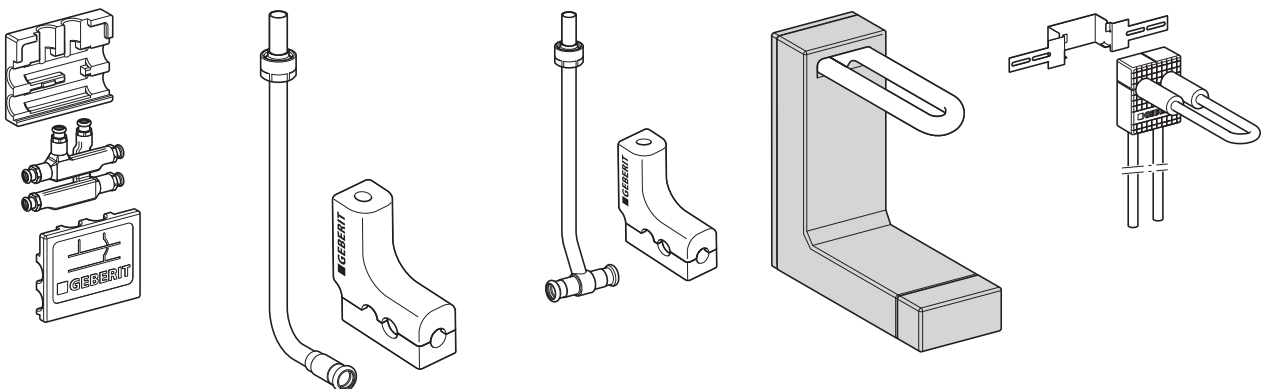

Figure 99: Geberit connections for heating

Accessories

The following accessories are available for Geberit Mapress Copper:

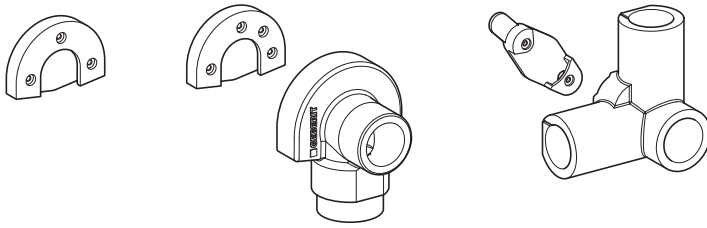

Figure 100: Geberit insulation for connections



Figure 101: Geberit contact protection, as a hose or adhesive tape, yellow

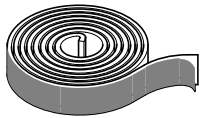
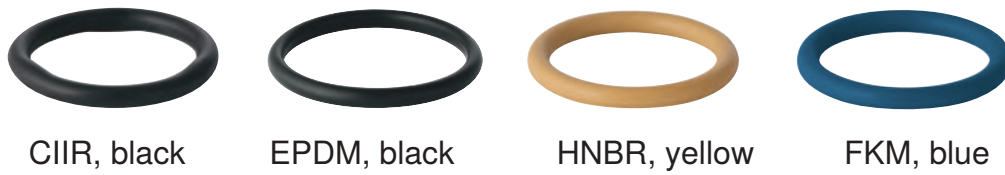

Figure 102: Geberit sealing tape



CIIR, black

EPDM, black

HNBR, yellow

FKM, blue

Figure 103: Geberit Mapress seal rings



EPDM, black

FPM, green

Centellen 3822

Centellen 3825

Centellen 3822

Figure 104: Geberit Mapress flat gaskets and flange gasket

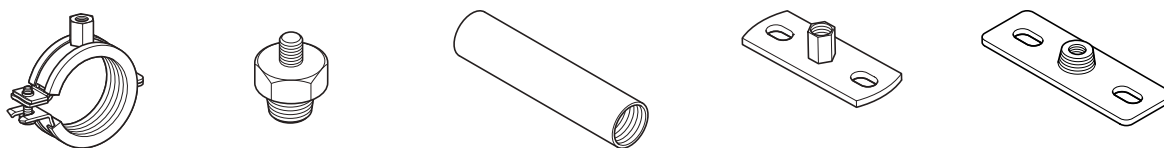

Figure 105: Geberit pipe fastenings

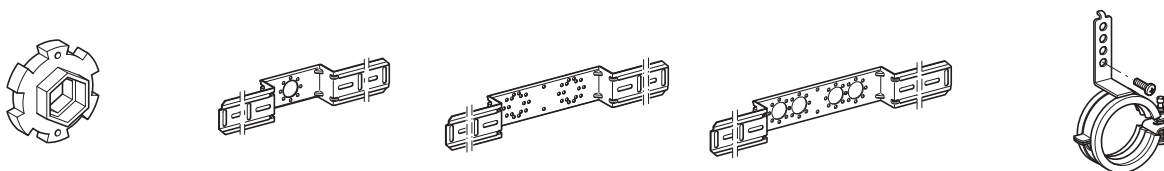

Figure 106: Geberit fastenings for connections

Pipe valve fittings

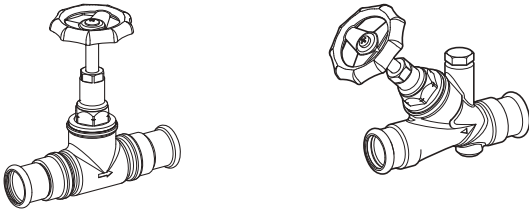

Figure 107: Geberit Mapress stop valves

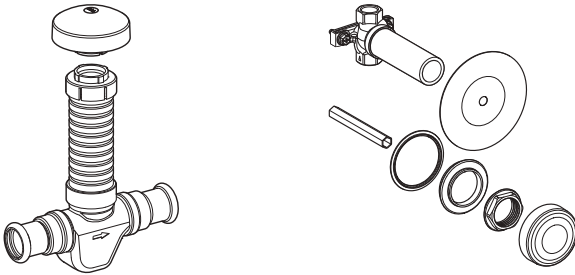

Figure 108: Geberit Mapress concealed stop valves



Figure 109: Geberit Mapress ball valves



Figure 110: Geberit Mapress concealed ball valves



Figure 111: Geberit Mapress Stainless Steel non-return valve, flanged

Further information on the different designs and applications as well as on various accessories such as actuator levers, handles and spindle extensions can be found in the online or printed catalogue.

1.4.3 Marking of copper pipes according to EN

All copper pipes must be marked on the surface.

The marking according to EN 10088-2 contains following information in the order given:

- manufacturer
- brand
- outer diameter x wall thickness
- European standard
- DVGW test mark
- country of manufacture
- building material class
- thermal insulation according to the Energy Savings Act

1.4.4 Application examples for fittings

Geberit Mapress Copper adapters, permanent

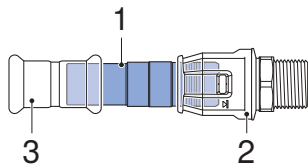

Figure 112: Connection to Geberit PushFit

- 1 Geberit PushFit connection to Geberit Mapress plain and push-fit end
- 2 Geberit PushFit push-fit fitting
- 3 Geberit Mapress Copper pressfitting (threaded socket)

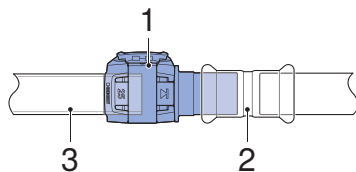

Figure 113: Connection to Geberit FlowFit

- 1 Geberit FlowFit adapter to Geberit Mapress, with plain end
- 2 Geberit Mapress Copper pressfitting (threaded socket)
- 3 Geberit system pipe ML or system pipe PB

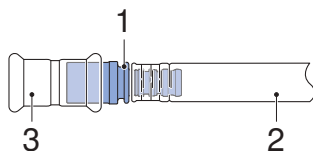

Figure 114: Connection to Geberit Mepla

- 1 Geberit Mepla adapter to Geberit Mapress, with plain end
- 2 Geberit Mepla system pipe
- 3 Geberit Mapress Copper pressfitting (threaded socket)

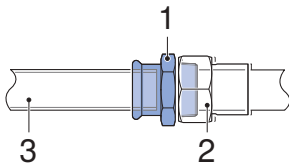

Figure 115: Connection to female thread

- 1 Geberit Mapress Copper adapter with male thread
- 2 Threaded socket with female thread
- 3 Copper pipe according to EN 1057

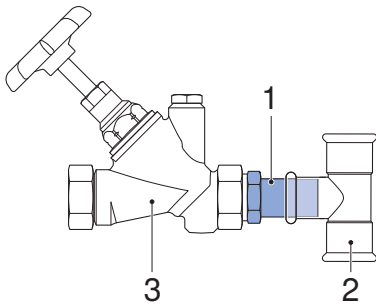

Figure 116: Connection to stop valve

- 1 Geberit Mapress Copper adapter with male thread and plain end
- 2 Geberit Mapress Copper pressfitting (T-piece)
- 3 Angle-seat valve

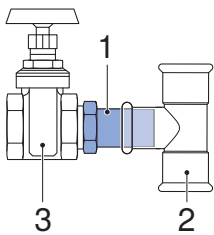

Figure 117: Connection to stop valve

- 1 Geberit Mapress Copper adapter with male thread and plain end
- 2 Geberit Mapress Copper pressfitting (T-piece)
- 3 Slide valves

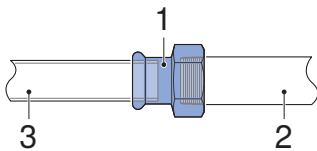

Figure 118: Connection to male thread

- 1 Geberit Mapress Copper adapter with female thread
- 2 Steel pipe with male thread
- 3 Copper pipe according to EN 1057

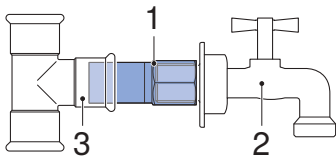

Figure 119: Connection to outside tap

- 1 Geberit Mapress Copper adapter with female thread and plain end
- 2 Outside tap with male thread
- 3 Geberit Mapress Copper pressfitting (T-piece)

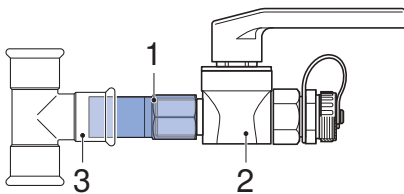

Figure 120: Connection to male thread

- 1 Geberit Mapress Copper adapter with union nut
- 2 Pipe valve fitting with male thread G (heating fill valve)
- 3 Geberit Mapress Copper T-piece

Geberit Mapress Copper adapters and connections, removable

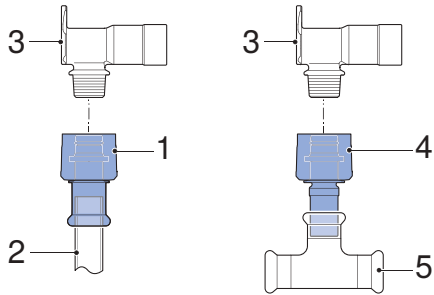

Figure 121: Tool-free connection with MasterFix

- 1 Geberit Mapress adapter with MasterFix
- 2 Copper pipe according to EN 1057
- 3 Fitting with male thread MF 1/2" (elbow tap connector 90°)
- 4 Geberit Mapress adapter with Geberit MasterFix and plain end
- 5 Geberit Mapress Copper pressfitting (T-piece)

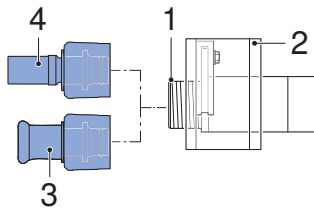

Figure 122: Tap connector, straight, with MasterFix

- 1 Geberit tap connector, straight, with male thread MF 1/2"
- 2 Mounting plate, sound insulation set
- 3 Geberit Mapress adapter with MasterFix
- 4 Geberit Mapress adapter with MasterFix and plain end

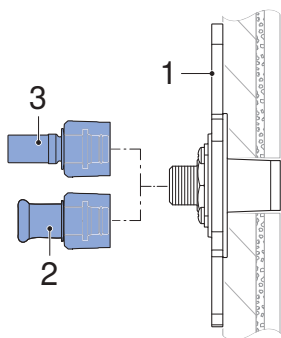

Figure 123: Tap connector, straight with Geberit MasterFix, drywall construction

- 1 Geberit tap connector set, straight, with male thread MF 1/2", premounted, drywall construction
- 2 Geberit Mapress adapter with MasterFix
- 3 Geberit Mapress adapter with MasterFix and plain end

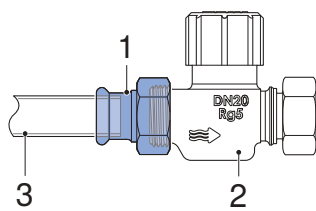

Figure 124: Connection to male thread

- 1 Geberit Mapress Copper adapter with union nut
- 2 Pipe valve fitting with male thread G
- 3 Copper pipe according to EN 1057

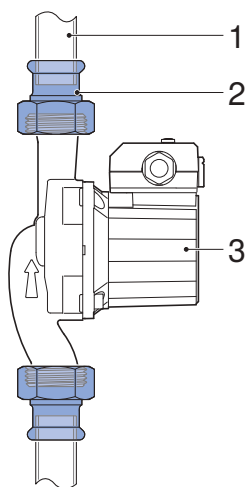

Figure 125: Connection to male thread

- 1 Copper pipe according to EN 1057
- 2 Geberit Mapress Copper adapter with union nut
- 3 Circulation pump with male thread G

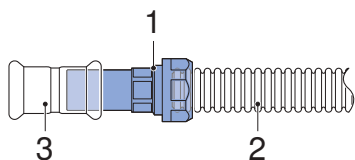

Figure 126: Connection to corrugated pipes

- 1 Geberit Mapress adapter union with clamping ring for corrugated pipes, non-potable water, plain end
- 2 Corrugated pipe
- 3 Geberit Mapress Copper pressfitting (threaded socket)

Geberit Mapress Copper adapters and connections (gas)

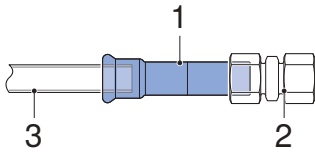

Figure 127: Adapter to cutting ring connection

- 1 Geberit Mapress Copper adapter to cutting ring connection (gas)
- 2 Cutting ring connection
- 3 Copper pipe according to EN 1057

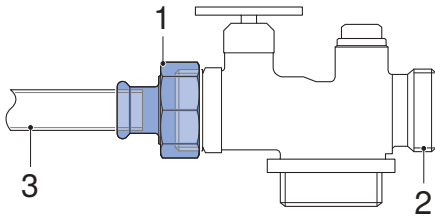

Figure 128: Connection to gas valves, conical-sealing

- 1 Geberit Mapress Copper adapter with union nut (gas)
- 2 Gas meter
- 3 Copper pipe according to EN 1057

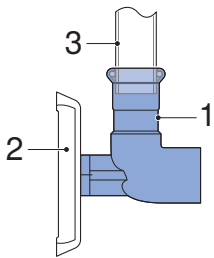

Figure 129: Connection for two-pipe gas meter

- 1 Geberit Mapress Copper elbow tap connector 90°, offset, circular hole 50 mm (gas)
- 2 Mounting bracket for gas meter
- 3 Copper pipe according to EN 1057

Geberit Mapress Copper connections for heating

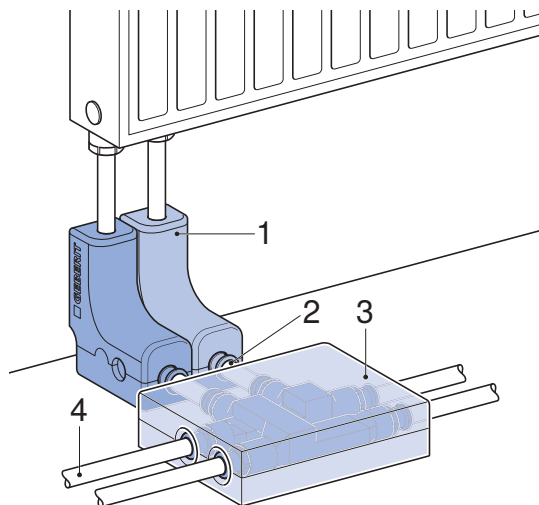

Figure 130: Radiator connection for pipe laying with a distance to the wall

- 1 Geberit Mapress metal pipe connector bend 90° with insulation box and union connector for Euro cone
- 2 Geberit Mapress Carbon Steel pipe nipple, outside zinc-plated
- 3 Geberit Mapress T-piece crossing with insulation box
- 4 Copper pipe according to EN 1057 (inlet / return flow)

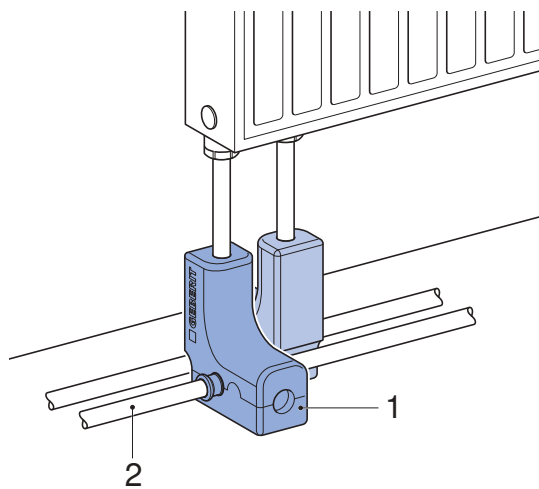

Figure 131: Radiator connection for pipe laying near the wall

- 1 Geberit Mapress metal pipe connection T-piece with insulation box and union connector for Euro cone
- 2 Copper pipe according to EN 1057 (inlet / return flow)

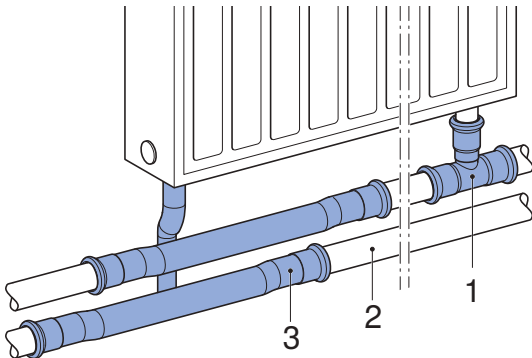

Figure 132: Connection for surface-mounted pipe (skirting board), with a distance between the inlet and return flow

- 1 Geberit Mapress Copper T-piece, reduced
- 2 Copper pipe according to EN 1057 (inlet / return flow)
- 3 Geberit Mapress Copper connector T-piece set for return flow

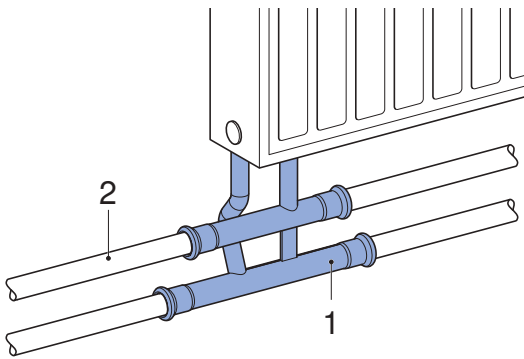

Figure 133: Connection for surface-mounted pipe (skirting board), with connector 4 cm

- 1 Geberit Mapress Copper connector T-piece for inlet and return flow
- 2 Copper pipe according to EN 1057 (inlet / return flow)

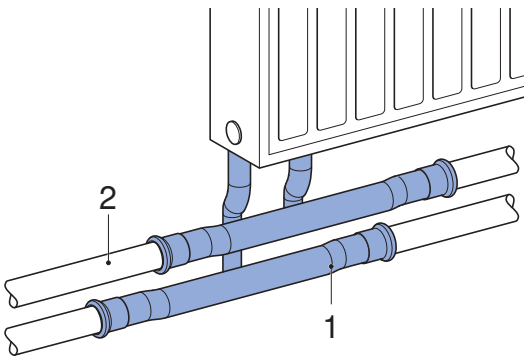

Figure 134: Connection for surface-mounted pipe (skirting board), with extendible connector

- 1 Geberit Mapress Copper connector T-piece set for inlet and return flow
- 2 Copper pipe according to EN 1057 (inlet / return flow)

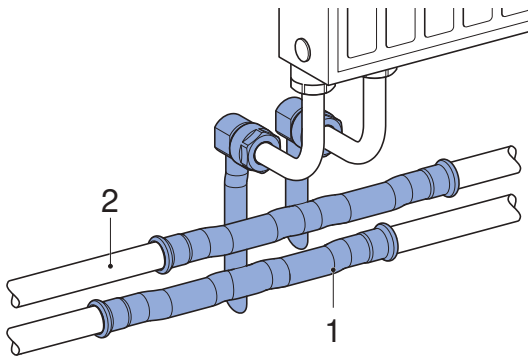

Figure 135: Skirting board connection with adapter with union connector for Euro cone

- 1 Geberit Mapress Copper connector T-piece set for inlet and return flow, with union connector for Euro cone
- 2 Copper pipe according to EN 1057 (inlet / return flow)

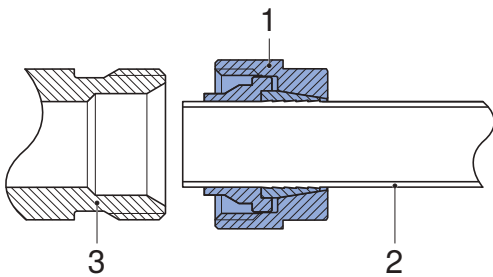

Figure 136: Union connector for Euro cone

- 1 Geberit adapter with union connector for Euro cone
- 2 Copper pipe according to EN 1057 (inlet / return flow)
- 3 Valve tap block with Euro cone

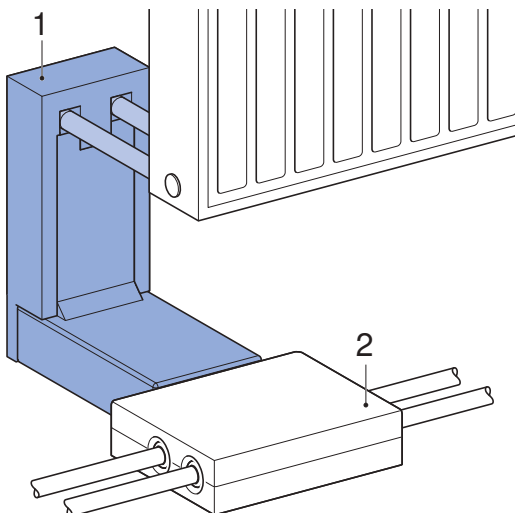

Figure 137: Radiator connector box type C for higher screed constructions

- 1 Geberit Mapress connector box type C
- 2 Geberit Mapress T-piece crossing with insulation box

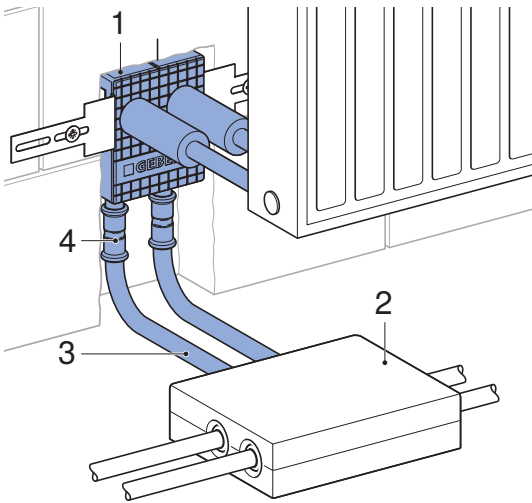

Figure 138: Radiator connector box type L for low screed constructions

- 1 Geberit Mapress connector box type L
- 2 Geberit Mapress T-piece crossing with insulation box
- 3 Copper pipe according to EN 1057 (inlet / return flow)
- 4 Geberit Mapress threaded socket

1.4.5 System characteristics

The following table gives an overview of the most important system characteristics of Geberit Mapress Copper:

Characteristic		Meaning
Diffusion barrier		Geberit Mapress Copper fittings and pressed joints form a barrier against diffusion.
Hot water resistance		Permanent 0–100 °C
Resistance to cold		Down to -30 °C provided that the medium in the pipe does not freeze.
Material abrasion		If the recommended flow rate is observed, no material abrasion occurs in the pipe.
UV resistance		UV-resistant
Corrosion resistance		Largely corrosion-resistant in normal, dry environments as well as against a variety of liquids and gaseous media. Corrosion protection is required in the event of contact with building materials containing sulphides, nitrites and ammonium, as well as in the case of installation in an aggressive environment.
Electrical conductivity		Electrically conductive, must be integrated into the main equipotential bonding.
Transmission of structure-borne sound		In the case of decoupling from the building structure, there is no transmission of structure-borne sound.
Fire behaviour		Copper pipes are non-combustible.

1.4.6 Certificates for Geberit Mapress Copper

The Geberit Mapress Copper systems have certificates from the following bodies, amongst others.

Certification body	Application
DVGW	Drinking water installations, gas installations
ÖVGW	
BSI	
CSTB	Drinking water installations
WRAS	
IMQ	Gas installations
KIWA-NL	
TÜV	TÜV component certificate with a supplementary expert report for industrial applications
DIBt	Industrial applications
ABS	Shipbuilding
BV	
CCS	
RINA	
RMRS	

1.4.7 Technical data

Copper pipes

The Geberit Mapress Copper range does not contain any pipes. The copper pipes according to EN 1057:2006+A1:2010 and DVGW GW 392:2015-04 listed in this product information are, however, part of the certification testing of Geberit Mapress Copper.

Copper pipes according to EN 1057

Product material and product material characteristics

Table 39: Material of copper pipes according to EN 1057

Strength (EN 1173)	Material designation	Abbreviation	Material number	
			EN	UNS
R220 (annealed)	Copper	Cu-DHP	CW024A	C12200
R250 (half hard)				
R290 (hard)				

Table 40: Physical properties of copper pipes according to EN 1057

Strength (EN 1173)	Tensile strength _{min} R _m [MPa]	Elongation at break _{min} A [%]
R220 (annealed)	220	40
R250 (half hard)	250	20
R290 (hard)	290	3

Pipe data

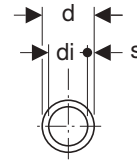
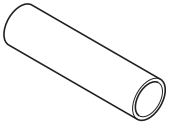

Table 41: Copper pipes according to EN 1057

DN	d [mm]	s [mm]	di [mm]	Strength (EN 1173)		
				R220 (annealed)	R250 (half hard)	R290 (hard)
10	12	0.6	10.8	—	✓	—
	12	0.8	10.4	✓	✓	
	12	1.0	10.0	✓	✓	
12	15	0.7	13.6	—	✓	—
	15	1.0	13	✓		
20	22	0.9	20.2	✓	✓	—
	22	1.2	19.6			
25	28	0.9	26.2	—	✓	✓
	28	1.2	25.6	✓		
32	35	1.0	33	—	—	✓
	35	1.2	32.6		✓	
	35	1.5	32		—	
40	42	1.0	40	—	—	✓
	42	1.2	39.6		✓	
	42	1.5	39		—	
50	54	1.0	52	—	—	✓
	54	1.2	51.6		✓	
	54	1.5	50		—	
60	66.7	1.2	64.3	—	—	✓
65	76.1	1.5	73.1	—	—	✓
	76.1	2.0	72.1			
100	108	1.5	105	—	—	✓
	108	2.5	103			

- ✓ Admissible, suitable for pressing
- Inadmissible, not suitable for pressing

Copper pipes according to DVGW GW 392

Product material and product material characteristics

Table 42: Material of copper pipes according to DVGW GW 392:2015-04 (EN 1057)

Strength (EN 1173)	Material designation	Abbreviation	Material number	
			EN	UNS
R220 (annealed)	Copper	Cu-DHP	CW024A	C12200
R250 (half hard)				
R290 (hard)				

Table 43: Physical properties of copper pipes according to DVGW GW 392:2015-04 (EN 1057)

Strength (EN 1173)	Tensile strength _{min}	Elongation at break _{min}
	R _m [MPa]	A [%]
R220 (annealed)	220	40
R250 (half hard)	250	20
R290 (hard)	290	3

Pipe data

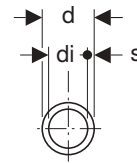
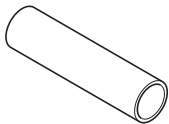

Table 44: Copper pipes according to DVGW GW 392:2015-04 (in accordance with EN 1057 and EN 13349)

DN	d [mm]	s [mm]	di [mm]	Strength (EN 1173)		
				R220 (annealed)	R250 (half hard)	R290 (hard)
10	12	0.8	10.4	✓	✓	✓
	12	1.0	10	✓	✓	✓
12	15	1.0	13	✓	✓	✓
15	18	1.0	16	✓	✓	✓
20	22	1.0	20	✓	✓	✓
25	28	1.0	26	—	✓	✓
	28	1.5	25	—	—	—
32	35	1.2	32.6	—	—	✓
	35	1.5	32	—	—	—
40	42	1.2	39.6	—	—	✓
	42	1.5	39	—	—	—
50	54	1.5	51	—	—	✓
	54	2.0	50	—	—	—
65	76.1	2.0	72.1	—	—	✓
80	88.9	2.0	84.9	—	—	✓
100	108	2.5	103	—	—	✓

- ✓ Available
- Not available

Pressfittings

Product material and product material characteristics



Table 45: Material of Geberit Mapress Copper pressfitting

Material designation	Copper
Abbreviation	Cu-DHP
Material number EN	CW024A
Material number UNS	C12200

Table 46: Material of Geberit Mapress Copper pressfittings, gunmetal

Material designation	Gunmetal
Abbreviation	CuSn5Zn5Pb2-C
Material number EN	CC499K
Material number UNS	— ¹⁾

1) No number according to the Unified Numbering System (UNS)

Table 47: Material of Geberit Mapress Copper pressfitting, DR brass

Material designation	DR brass
Abbreviation	CuZn36Pb2As
Material number EN	CW602N
Material number UNS	C35330

Table 48: Material of Geberit Mapress Copper pressfitting, brass

Material designation	Brass
Abbreviation	CuZn40Pb2
Material number EN	CW617N
Material number UNS	C38000

For information on the recycling code of the pressing indicator and protection plug, see the 'Disposal' chapter.





Table 49: Physical properties of Geberit Mapress Copper pressfitting

Thermal expansion coefficient α at 20–100 °C	16.6 · 10 ⁻⁶ m/(m·K)	
Thermal conductivity λ at 20 °C	305 W/(m·K)	
Specific thermal capacity c at 20 °C	386 J/(kg·K)	
Surface roughness k	0.001 mm	
Building material class	EN 13501	A1
	DIN 4102 Part 1	A1

System seals

Material and temperature resistance

Table 50: Geberit Mapress seal rings for Geberit Mapress Copper





	CIIR, black 	EPDM, black 	HNBR, yellow 	FKM, blue 	
d [mm]	12–54	66.7–108	15–54	12–54	
Material	Chlorinated butyl rubber	Ethylene propylene diene monomer rubber	Hydrogenated acrylonitrile-butadiene rubber	Fluoro rubber	
Operating temperature ¹⁾ [°C]	-30 – +120	-30 – +120	-20 – +70	-25 – +140 ²⁾	-25 – +180 ³⁾
Leaky if unpressed	✓	–	✓	–	

✓ Applies

– Does not apply



- 1) Additional information on the operating temperatures, together with the uses and operating pressures, is given in the respective usage overviews. The current usage overviews can be found in the online catalogue or in the printed catalogue.
- 2) Use only approved antifreeze agent according to the "Corrosion and antifreeze agent" technical information.
- 3) When used in thermal media (solar): Service life with collector downtime: 200 h/a at 180 °C, 60 h/a at 200 °C, total service life: 500 h at 220 °C.

Table 51: Geberit Mapress flat gaskets for Geberit Mapress Copper

	EPDM, black 	FPM, green 	Centellen® HD WS 3822 	Centellen® HD WS 3825 
G	1/2 to 2 3/8"	3/4 to 2 3/8"	3/4 to 2 3/8"	1/2 to 3 1/2"
Material	Ethylene propylene diene monomer rubber	Fluoro rubber	Aramid fibres with inorganic reinforcing materials and rubber as a binding material	Aramid fibres with inorganic reinforcing materials and rubber as a binding material
Operating temperature ¹⁾ [°C]	0–100	-30 – +180	-20 – +155	-30 – +150

- 1) Additional information on the operating temperatures, together with the uses and operating pressures, is given in the respective usage overviews. The current usage overviews can be found in the online catalogue or in the printed catalogue.

Table 52: Geberit Mapress flange gasket and O-rings for Geberit Mapress Copper

	Geberit Mapress flange gasket Centellen® HD WS 3822 	O-rings for Geberit Mapress screw connections, conical-sealing, gas 
Nominal width DN	15–100	–
G	–	7/8, 1 1/8 and 1 3/8"
Material	Aramid fibres with inorganic reinforcing materials and rubber as a binding material	Hydrogenated acrylonitrile-butadiene rubber
Operating temperature [°C]	-30 – +180	-20 – +70

– Does not apply



The operating conditions specified in the relevant approvals, standards and technical regulations must be observed for each application. These may differ from the information in the usage overviews.

Maximum axial load of pressed joints

The following maximum axial loads apply when using Geberit Mapress Copper pressed joints:

Table 53: Maximum axial load of the pressed joint for connections with copper pipes with different strengths (R) according to EN 1173

Pressing attachment	d [mm]	s [mm]	Maximum axial load [N]		
			R220	R250	R250
Pressing jaw with compatibility [2]/[3]	12	1.0	600	900	900
	15	1.0	800	1000	1000
	18	1.0	1000	1000	1100
	22	1.0	1000	1100	1600
	28	1.5	—	1400	2200
	35	1.2	—	—	1600
Pressing collar with compatibility [2]/[3]/[2XL]	35	1.5	—	—	—
	42	2.0	—	—	3800
	54	2.0	—	—	4800
	66.7	1.2	—	—	11900
	76.1	2.0	—	—	14000
	88.9	2.0	—	—	17600
	108	2.5	—	—	34800

— Does not apply

1.5 GEBERIT MAPRESS CUNIFE

1.5.1 Overview of Geberit Mapress CuNiFe

Geberit Mapress CuNiFe is a supply system in which pipes and fittings made of a copper-nickel-iron alloy (CuNiFe) are pressed to form permanent, technically tight pipes.

Due to its excellent corrosion resistance to seawater, Geberit Mapress CuNiFe is suitable for applications that come into contact with seawater. The system covers many applications in the (offshore) industry and in shipbuilding due to the wide range of possible combinations of pipes, fittings and seal rings.



The most common uses for Geberit Mapress CuNiFe are listed below. Other applications (media), together with the operating temperatures and operating pressures, are listed in the respective usage overviews.



The current usage overviews can be found in the online catalogue or in the printed catalogue.



The operating conditions specified in the relevant approvals, standards and technical regulations must be observed for each application. These may differ from the information in the usage overviews.

Seal ring	Fitting	System pipe	Combined pipe and fitting dimensions	Most common uses
 <p>CIIR, black</p>	 <p>CuNi10Fe1.6Mn</p>	 <p>CuNi10Fe1.6Mn</p>	<p>d15–108 mm</p>	<ul style="list-style-type: none"> • Cooling water • Service water • Grey and black water with a pH value < 6.0 • Seawater • Wet extinguishing water • Wet/dry sprinklers • Bilges

1.5.2 System components

The Geberit Mapress CuNiFe system consists of the following components:

- system pipes
- fittings with system seals
- pipe valve fittings
- accessories
- tools

System pipes

Geberit Mapress CuNiFe system pipe



Outer diameter	15–108 mm
Description	<ul style="list-style-type: none"> • Material CuNi10Fe1.6Mn • Material number 2.1972.11 • With a black protection plug
Additional features guaranteed by the Geberit works standard	<ul style="list-style-type: none"> • Seamlessly drawn
Properties	<ul style="list-style-type: none"> • When exposed to clean seawater, it forms a natural thin protective coating predominantly of copper oxide, which makes the pipe corrosion-resistant • Bendable from d15–108 mm¹⁾

1) Can be bent by hand up to a pipe diameter of d28 mm. Special pipe bending machines are required for bending from a diameter of d35 mm.

Pressfittings

Geberit Mapress CuNiFe pressfitting with seal ring CIIR, black



Outer diameter	15–108 mm
Description	<ul style="list-style-type: none"> • Pressfitting made of CuNi10Fe1.6Mn for industry and shipbuilding • Transparent protection plug • Black pressing indicator • Seal ring CIIR, black
Properties	<ul style="list-style-type: none"> • Leaky if unpressed

Geberit Mapress CuNiFe pressfitting with seal ring FKM, blue



Outer diameter	d15–108 mm
Description	<ul style="list-style-type: none"> • Pressfitting made of CuNi10Fe1.6Mn for shipbuilding • Black protection plug • Black pressing indicator • Seal ring FKM, blue

Fittings

Standard fittings

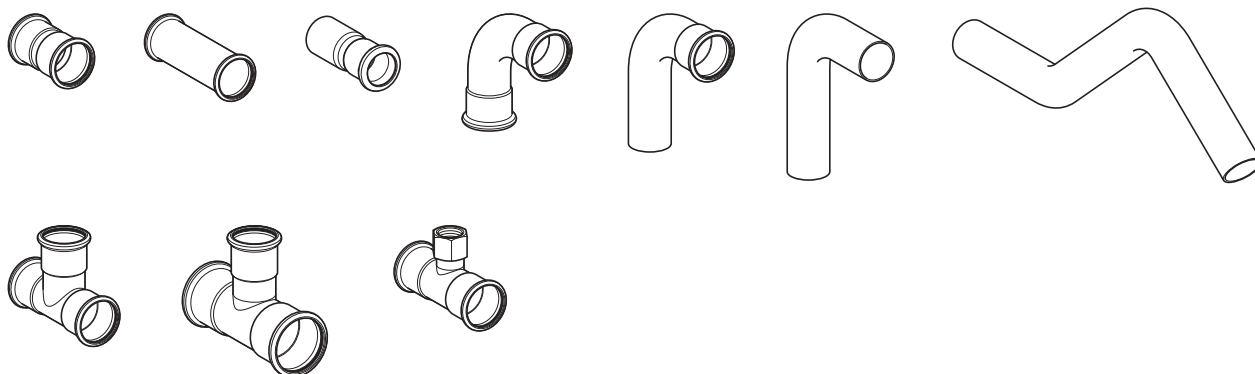

Figure 139: Geberit Mapress CuNiFe standard fittings

Adapters, permanent



Figure 140: Geberit Mapress CuNiFe adapters with male thread and adapters with female thread

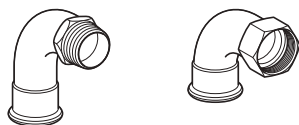

Figure 141: Geberit Mapress CuNiFe bend adapters 90°

Adapters and connections, removable



Figure 142: Geberit Mapress CuNiFe adapter union

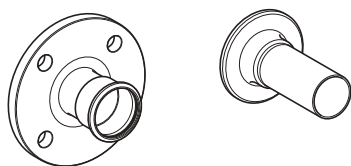

Figure 143: Flange connections

Bulkhead and deck passing

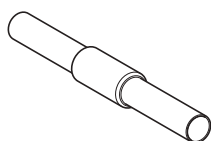

Figure 144: Geberit Mapress CuNiFe bulkhead and deck passing

Accessories

The following accessories are available for Geberit Mapress CuNiFe:



CIIR, black FKM, blue

Figure 145: Geberit Mapress seal rings



EPDM, black FPM, green Centellen 3822 Centellen 3825 Centellen 3822

Figure 146: Geberit Mapress flat gaskets and flange gasket

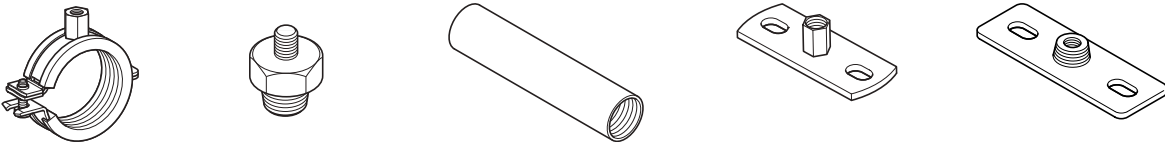

Figure 147: Geberit pipe fastenings

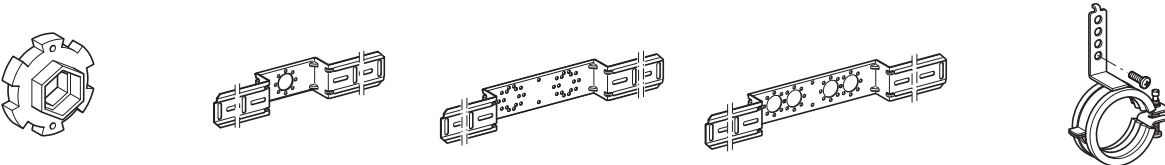

Figure 148: Geberit fastenings for connections









1.5.3 Marking of Geberit Mapress CuNiFe system pipes

The marking of Geberit Mapress CuNiFe system pipes includes the information in the table in the order shown. A pipe with a dimension of d28 mm is used as an example.

Eucaro 10	Manufacturer's material designation
MAPRESS	Product name
DIN 86019	DIN standard: Seamless pipes made of CuNi10Fe1.6Mn for pipelines
CuNi10Fe1.6MN	Short material designation
28 x 1.5	Outer pipe diameter and wall thickness [mm]
CHR NO xxxx	Melt number

1.5.4 System characteristics

The following table gives an overview of the most important system characteristics of Geberit Mapress CuNiFe:

Characteristic		Meaning
Diffusion barrier		Geberit Mapress CuNiFe fittings, pipes and pressed joints form a barrier against diffusion.
Hot water resistance		Permanent 0–100 °C
Resistance to cold		Down to -30 °C under the condition that the medium in the pipe does not freeze
Material abrasion		If the recommended flow rate is observed, no material abrasion occurs in the pipe.
UV resistance		Geberit Mapress CuNiFe is UV-resistant and therefore also suitable for outdoor use.
Corrosion resistance		Largely corrosion-resistant, especially to seawater and also to a variety of liquids and gaseous media
Electrical conductivity		Electrically conductive, must be integrated into the main equipotential bonding.
Transmission of structure-borne sound		In the case of decoupling from the building structure, there is no transmission of structure-borne sound.
Fire behaviour		Geberit metal pipes are non-combustible.

1.5.5 Geberit Mapress CuNiFe certificates

The Geberit Mapress CuNiFe system has certificates from the following bodies, amongst others:

Certification body	Application
ABS	Shipbuilding
BV	
CCS	
DNV	
LRS	
RINA	
RMRS	

1.5.6 Technical data

Geberit Mapress CuNiFe system pipe

Product material and product material characteristics



Table 54: Material

Material designation	Copper-nickel forging alloy	
Short name according to EN 10088	CuNi10Fe1.6Mn	
Material number	2.1972.11	

Table 55: Physical characteristics

Thermal expansion coefficient α at 20–100 °C	0.017 mm/(m·K)	
Thermal conductivity λ at 20 °C	50 W/(m·K)	
Specific thermal capacity c at 20 °C	377 J/(kg·K)	
Surface roughness k	10 μm	
Building material class	EN 13501	A1
	DIN 4102 Part 1	A1

Table 56: Mechanical characteristics

Tensile strength R_m	300-400 N/mm ²
0.2% expansion limit $R_{p0.2}$	100-180 N/mm ²
Elongation at break A_5	> 30 %

Pipe data

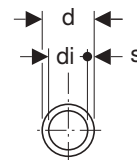
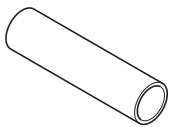

Table 57: Geberit Mapress CuNiFe system pipe 2.1972.11

DN	d [mm]	s [mm]	di [mm]	m_R [kg/m]	m_{RW} [kg/m]	V [l/m]
12	15	1	13	0.390	0.530	0.133
20	22	1	20	0.590	0.910	0.314
20	22	1.5	19	0.860	1.150	0.284
25	28	1.5	25	1.110	1.610	0.491
32	35	1.5	32	1.410	2.230	0.804
40	42	1.5	39	1.700	2.920	1.195
50	54	1.5	51	2.210	4.300	2.043
65	76.1	2	72.1	4.140	8.320	4.083
80	88.9	2	84.9	4.870	10.660	5.661
100	108	2.5	104	7.380	15.910	8.332

m_R Pipe weight

m_{RW} Pipe weight with water 25 °C, salt content 35g/kg, pressure 1 atm

V Pipe volume

Geberit Mapress CuNiFe pressfitting

Product material and product material characteristics



Table 58: Material



Material designation	Copper-nickel forging alloy
Abbreviation	CuNi10Fe1.6Mn
Material number DIN	2.1972

For information on the recycling code of the pressing indicator and protection plug, see the 'Disposal' chapter.

System seals

Material and temperature resistance

Table 59: Geberit Mapress seal rings for Geberit Mapress CuNiFe

	CIIR, black 	FKM, blue 
d [mm]	15–108	15–108
Material	Chlorinated butyl rubber	Fluoro rubber
Operating temperature ¹⁾ [°C]	-30 – +120	-25 – +140 ²⁾
Leaky if unpressed	✓	–

✓ Applies

– Does not apply

- 1) Additional information on the operating temperatures, together with the uses and operating pressures, is given in the respective usage overviews. The current usage overviews can be found in the online catalogue or in the printed catalogue.
- 2) Use only approved antifreeze agent according to the "Corrosion and antifreeze agent" technical information.

CHAPTER TWO

PRACTICAL USE

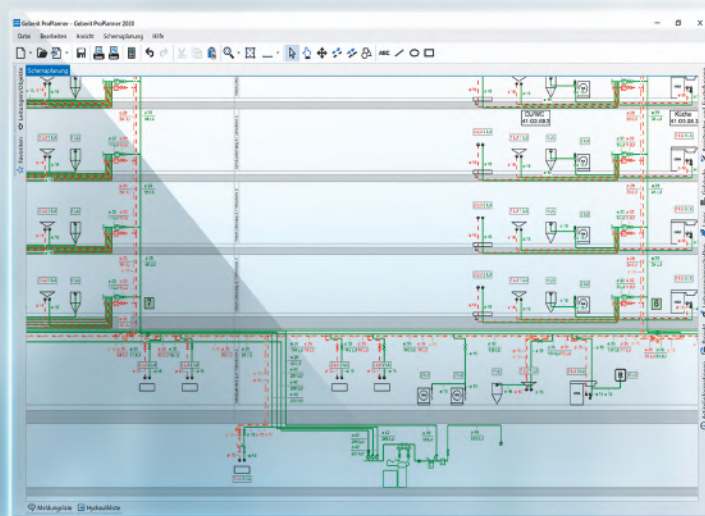
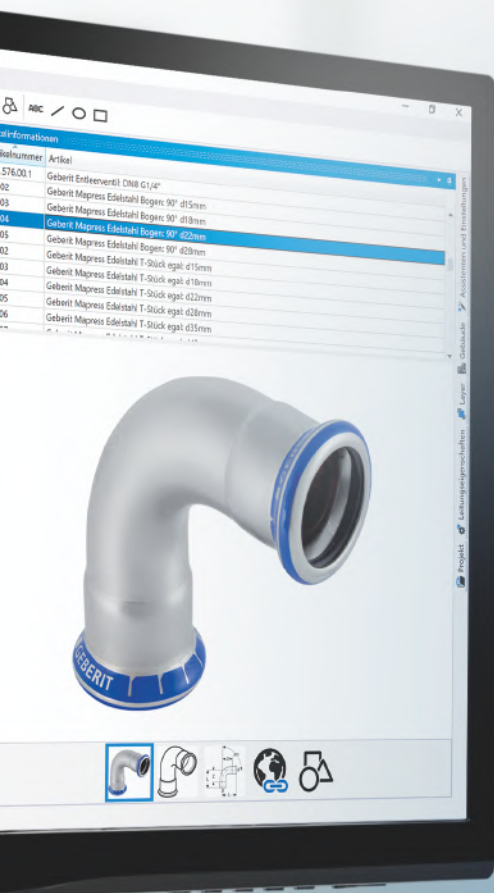

2.1 DETERMINATION OF THE PIPE DIMENSION

The aim of determining the pipe dimension is to supply the user with sufficient hygienically perfect drinking water under optimum pressure conditions.

The determination of the pipe dimension has changed drastically in drinking water installations for the following reasons, amongst others:

- increased number of points of use, e.g. due to there being several sanitary rooms in apartments
- falling occupancy rate per apartment
- new installation techniques
- different user behaviour

Country-specific standards and regulations need to be considered for the determination of the pipe dimension.

Depending on the applicable standards, the pipe dimensions can be determined using one of the following methods:

- simplified method
- calculation method

System-related loading unit tables are required for the simplified method.

Alternatively, Geberit offers the Geberit loading unit tables for the quick and easy determination of the pipe dimension in small and medium-sized objects.

The pipe dimensions are calculated according to pressure loss with the calculation method.

In addition to diagrams and pressure loss tables, Geberit offers the following aids for determining the pipe dimension with the calculation method:

- Geberit pressure loss calculation, can be downloaded as an Excel tool from the website of the sales company responsible for Service / Services / Determining the pipe dimension for water
- Geberit ProPlanner planning software
- Geberit Pro app for quickly calculating individual sections

2.1.1 Loading units

The loading unit is the basis for all calculation methods. It denotes the flow rate available at the connection point before the point of use depending on the application purpose and the period of use. A loading unit corresponds to an outlet flow rate of 0.1 l/s.

Table 60: Loading units LU per consumer according to SVGW directive W3, edition 2013

Consumers with connection DN 15 (1/2")	Q _A cold [l/s]	Q _A hot [l/s]	LU cold	LU hot
WC cistern, drinks dispenser	0.1	—	1	—
Washbasin, washing trough, bidet, hairdresser shower	0.1	0.1	1	1
Household dishwasher	0.1	—	1	—
Household washing machine	0.2	—	2	—
Outlet tap for balcony	0.2	—	2	—
Shower, kitchen sink, sink, cleaner sink, pedestal and wall-hung sink	0.2	0.2	2	2
Automatic urinal water flush	0.3	—	3	—
Bathtub	0.3	0.3	3	3
Outlet tap for garden and garage	0.5	—	5	—

— No hot water connection available

Q_A Outlet flow rate

LU Loading unit (Loading Unit)

The following must be observed when determining the pipe dimension:

- Heating filling valves must not be included.
- Consumers with connections larger than 1/2" and / or special flow capacities must always be calculated according to pressure loss in accordance with manufacturer specifications.

2.1.2 Geberit loading unit tables

The Geberit loading unit tables for the Geberit drinking water supply systems are considered an alternative to the simplified method for determining the pipe dimension according to SVGW directive W3 for drinking water installations, edition 2013.

The pressure conditions and maximum flow velocities specified in the SVGW W3 are adhered to in the Geberit loading unit tables taking the following criteria into account:

- no points of use larger than specified in the loading unit table
- the peak flow must not be exceeded according to SVGW directive W3, edition 2013, diagram 1
- no continuous use (longer than 15 minutes)
- maximum height difference of 12 m between distribution battery and highest point of use
- static pressure of 5 bar after the water pressure reducing valve
- maximum 150 LU and maximum 50 m unwound pipe length for each stack from the distributor battery

Table 61: Geberit Mapress system pipes

	Total loading units LU						
	2	3	5	8	16	50	150
Largest loading unit LU	2		3		5		
Pipe dimension d _a [mm]	15		18		22	28	35
Inner diameter d _i [mm]	13		16		19.6	25.6	32
Recommended pipe length [m]	15	9	7	–	–	–	–

LU Loading Unit

2.2 CALCULATIONS WITH PRESSURE LOSSES

2.2.1 Total pressure loss in an installation

The total pressure loss in an installation is derived from the sum of the

- pressure losses through pipe friction in pipes
- pressure losses from the individual resistances of fittings

$$\Delta p_{\text{tot}} = \Delta p_{\text{R}} + \Delta p_{\text{E}}$$

Δp_{d} Total pressure loss

ead

Δp_{R} Pressure loss through pipe friction [Pa]

Δp_{E} Pressure loss from individual resistances [Pa]

100,000 PA = 100 kPa = 1 bar = 1000 mbar

2.2.2 Pressure loss through pipe friction in pipes

The pressure loss through pipe friction Δp_{R} is the product of pressure drop R (pressure drop through pipe friction in the straight pipe) and the pipe length L. The pressure drop R is dependent on the volumetric flow rate, inner diameter, pipe material and temperature.

The pressure drop is calculated with the following formula:

$$\Delta p_{\text{R}} = R \cdot L$$

Δp_{R} Pressure loss through pipe friction [Pa]

R Pressure drop [Pa/m]

L Pipe length [m]

2.2.3 Pressure loss diagrams for Geberit Mapress Stainless Steel system pipes

The pressure losses of straight system pipes can also be found in the following diagrams.

Drinking water 10 °C

Medium:	Water	Viscosity:	0.0013 Pa•s
Temperature:	10 °C	Surface roughness:	0.0015 mm
Density:	999.7 kg/m ³		

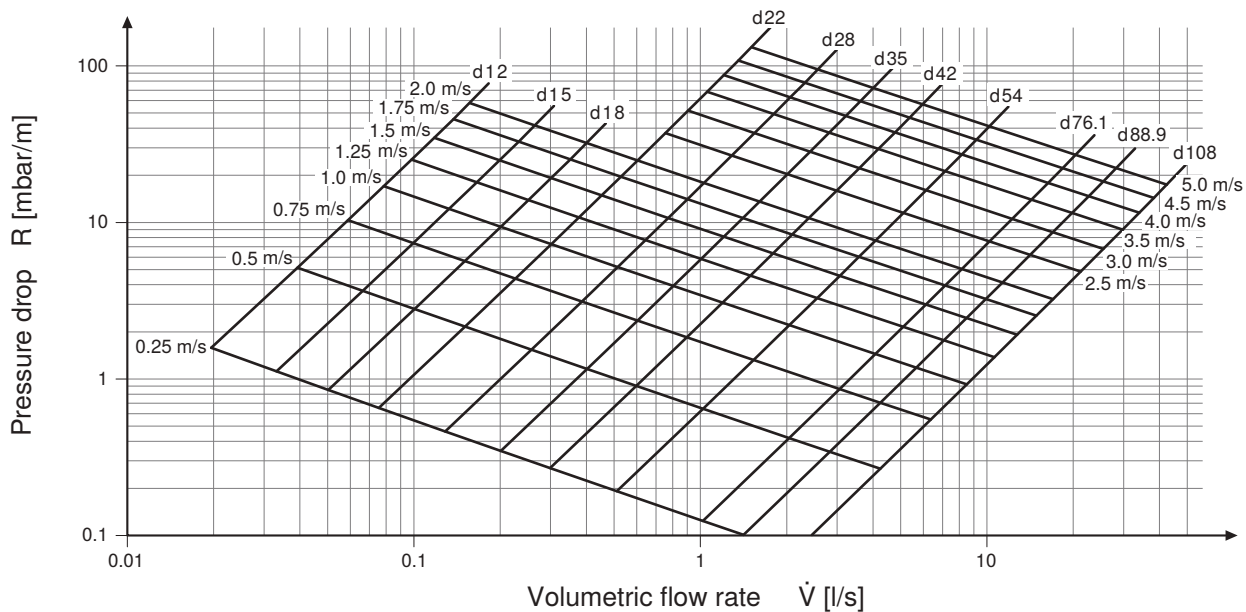

Figure 149: Pressure losses in Geberit Mapress Stainless Steel system pipes, potable water 10 °C

Admissible flow velocities (Geberit recommendation):

Discharge pipe:	max. 3.0 m/s
Storey distribution:	max. 3.0 m/s
Distribution pipes:	max. 2.0 m/s

Drinking water 60 °C

Medium:	Water	Viscosity:	0.0046 Pa•s
Temperature:	60 °C	Surface roughness:	0.0015 mm
Density:	983.23 kg/m ³		

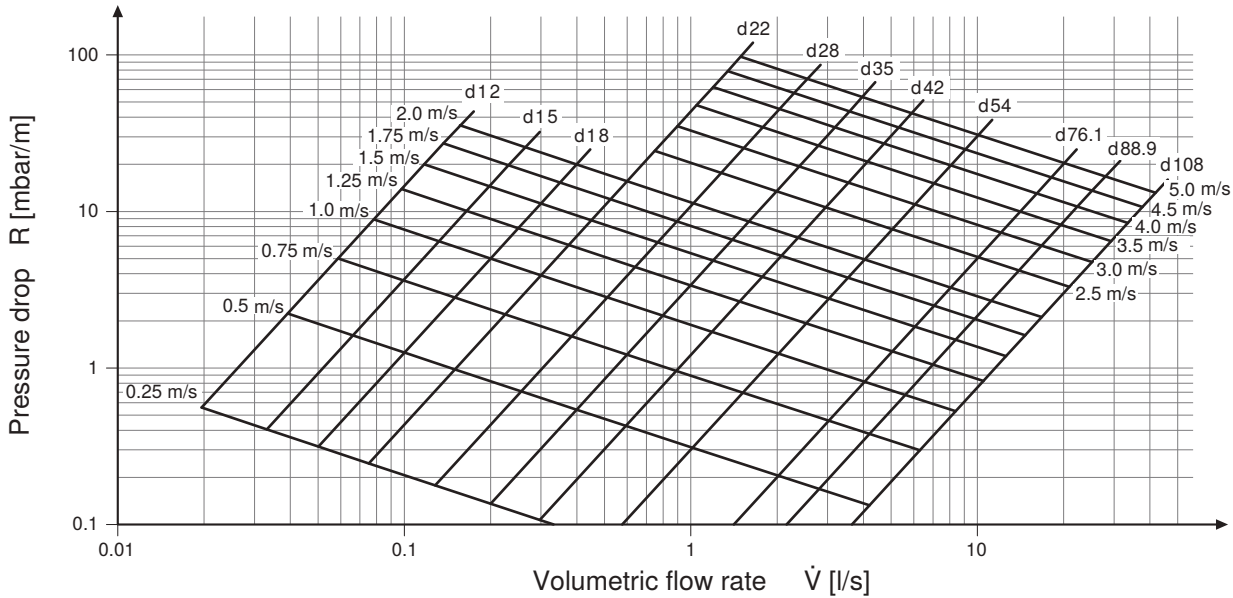

Figure 150: Pressure losses in Geberit Mapress Stainless Steel system pipes, potable water 60 °C

Admissible flow velocities (Geberit recommendation):

Discharge pipe:	max. 3.0 m/s
Storey distribution:	max. 3.0 m/s
Distribution pipes:	max. 2.0 m/s

2.2.4 Pressure loss from individual resistances

Changes in direction in pipes or speed changes, for example, in bent pipe sections, branch fittings or valves, additionally cause pressure losses due to individual resistances.

The essential size for determining an individual resistance is the pressure loss coefficient ζ (Zeta value), a dimensionless size with which the resistance to the dynamic pressure of the water is represented. The pressure loss coefficient must be determined empirically. Geberit provides tables with the pressure loss coefficients for Geberit fittings. The values were determined according to the techniques defined in the technical testing regulations W 575 (P) of the German Technical and Scientific Association for Gas and Water (DVGW) from 2012.

The pressure loss from individual resistances Δp_E is derived from the sum of the pressure loss coefficients ζ (Zeta values) multiplied by the dynamic pressure:

$$\Delta p_E = Z = \sum \zeta \cdot \frac{\rho}{2} \cdot v^2 \quad \left[\frac{\text{kg} \cdot \text{m}^2}{\text{m}^3 \cdot \text{s}^2} = \frac{\text{N}}{\text{m}^2} = \text{Pa} \right]$$

Δp_E Pressure loss from individual resistances [Pa]

∑ζ Sum of the pressure loss coefficients [factor]

ρ Density [kg/m³]

v Speed [m/s]

Pressure loss coefficients

The pressure loss coefficients were calculated based on SVGW (SN EN 1267) and DVGW (W 575) specifications.

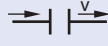



Table 62: Pressure loss coefficient ζ (Zeta values) Geberit Mapress Stainless Steel, d12–35 mm

			d [mm]					
			12	15	18	22	28	35
Bend 90° (W90)			0.44	0.45	0.42	0.39	0.34	0.54
Bend 45° (W45)			0.35	0.34	0.3	0.29	0.26	0.4
T-piece Branch fitting (TA)			1.07	1.17	1.19	1.15	1.18	1.86
T-piece Through-flow (TD)			0.22	0.2	0.16	0.16	0.12	0.26
Threaded socket (K)			0.2	0.17	0.14	0.14	0.1	0.17
Reducer (RED)			18/12 0.19	22/15 0.13	22/18 0.12	35/22 0.14	54/28 0.12	42/35 0.14
Elbow tap connector 90° (WS)			0.93	1.1	1.18	1.07	—	—

- v The symbol v marks the reference cross-section.
- The arrow marks the cross-sections flowing through during the measurement.
- Flow situation does not apply to any application.

Table 63: Pressure loss coefficient ζ (Zeta values) Geberit Mapress Stainless Steel, d42–108 mm

			d [mm]				
			42	54	76.1	88.9	108
Bend 90° (W90)			0.33	0.31	0.29	0.28	0.26
Bend 45° (W45)			0.2	0.19	0.18	0.17	0.16
T-piece Branch fitting (TA)			1.17	1.2	1.35	1.35	1.35
T-piece Through-flow (TD)			0.11	0.09	0.05	0.05	0.05

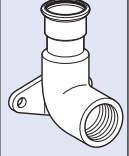
			d [mm]				
			42	54	76.1	88.9	108
Threaded socket (K)			0.09	0.07	0.03	0.03	0.03
Reducer (RED)			54/42 0.08	88.9/54 0.08	108/76.1 0.03	108/88.9 0.03	-
Elbow tap connector 90° (WS)			-	-	-	-	-

2 / 2

- v The symbol v marks the reference cross-section.
- The arrow marks the cross-sections flowing through during the measurement.
- Flow situation does not apply to any application.

Equivalent pipe length

The individual resistances can be taken into account in a simplified manner with the equivalent pipe length instead of the pressure loss coefficient (Zeta value). The equivalent pipe length indicates which length of a straight pipe corresponds to the pressure loss of a fitting or valve with a known individual resistance number.









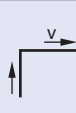
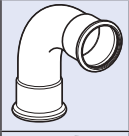

The equivalent pipe length must be added to the pipe length and multiplied by the corresponding pipe friction pressure drop.

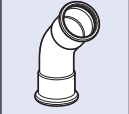
The equivalent pipe lengths corresponding to the individual resistances can be found in the tables entitled "Equivalent pipe lengths".

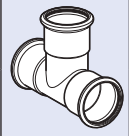
Equivalent pipe lengths

The equivalent pipe lengths were determined based on the guidelines of the SVGW (SN EN 1267) and DVGW (W 575).

Table 64: Equivalent pipe lengths in metres Geberit Mapress Stainless Steel, d12–35 mm

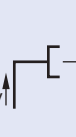
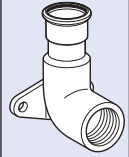









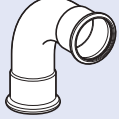

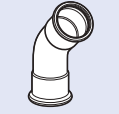
			d [mm]					
			12	15	18	22	28	35
Bend 90° (W90)			0.18	0.22	0.26	0.33	0.42	0.54
Bend 45° (W45)			0.14	0.17	0.19	0.25	0.3	0.4
T-piece Branch fitting (TA)			0.44	0.65	0.83	1.03	1.45	1.86
T-piece Through-flow (TD)			0.09	0.11	0.12	0.16	0.19	0.26
Threaded socket (K)			0.08	0.09	0.09	0.12	0.12	0.17
Reducer (RED)			18/12 0.1	22/15 0.07	22/18 0.08	35/22 0.09	54/28 0.12	42/35 0.14
Elbow tap connector 90° (WS)			0.36	0.56	0.78	0.9	—	—

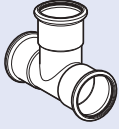
v The symbol v marks the reference cross-section.

→ The arrow marks the cross-sections flowing through during the measurement.

— Flow situation does not apply to any application.

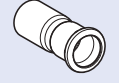
Table 65: Equivalent pipe lengths in metres Geberit Mapress Stainless Steel, d42–108 mm

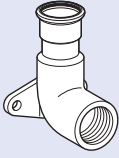
			d [mm]				
			42	54	76.1	88.9	108
Bend 90° (W90)			0.66	0.86	1.11	1.33	1.68
Bend 45° (W45)			0.47	0.6	0.66	0.78	0.99
T-piece Branch fitting (TA)			2.43	3.47	5.74	7.06	9.14
T-piece Through-flow (TD)			0.3	0.37	0.33	0.39	0.47
Threaded socket (K)			0.18	0.19	0.12	0.15	0.19
Reducer (RED)			54/42 0.16	88.9/54 0.22	108/76.1 0.12	108/88.9 0.15	—
Elbow tap connector 90° (WS)			—	—	—	—	—

- v The symbol v marks the reference cross-section.
- The arrow marks the cross-sections flowing through during the measurement.
- Flow situation does not apply to any application.

2.2.5 Square Law

The pressure loss is proportional to the square of the volumetric flow rate. As a result, a volumetric flow rate reduced by half still represents a quarter of the pressure loss. The volumetric flow rate is therefore a value that significantly influences the pressure loss.

$$\frac{\Delta p_1}{\Delta p_2} = \frac{\dot{V}_1^2}{\dot{V}_2^2} \quad \left[\frac{\text{mbar}}{\text{mbar}} = \frac{\text{l} \cdot \text{s}}{\text{s} \cdot \text{l}} \right]$$

- Δp_1 Pressure loss before change [mbar]
- Δp_2 Pressure loss after change [mbar]
- \dot{V}_1 Volumetric flow rate before change [l/s]
- \dot{V}_2 Volumetric flow rate after change [l/s]

2.3 HOT WATER DRAW-OFF TIMES

The draw-off time is defined as the maximum time it takes hot water to flow through the point of use at the effective temperature. Draw-off times should not be too high in the interest of economical water and energy consumption and should meet the user's comfort requirements. The draw-off time is calculated for individual supply pipes in the storey distribution.

The draw-off time is influenced by the following parameters:

- arrangement of the sanitary appliances
- hot water distribution (laying technique)
- pipe dimension
- pipe length
- hot water temperature
- volumetric flow rate

Country-specific regulations apply for the draw-off times. Planning software, such as Geberit ProPlanner, is available to calculate draw-off times. It issues warnings if the defined draw-off time is exceeded, for example.

2.3.1 Reference values for draw-off times

The draw-off times specified in the following table apply when the outlet taps set to hot are fully open. The calculations and measurements of SIA 385-2:2015 are based on an effective temperature of 40 °C at the point of use of the hot water. A temperature of 40 °C signals the start of the usability of the hot water according to SIA 385-1:2020.

Table 66: Maximum admissible draw-off time (according to SIA 385-1:2020)

Point of use	Draw-off time [s]	
	Without heat maintenance (e.g. without circulation)	With heat maintenance (e.g. with circulation)
Washbasin, handrinse basin, bidet, shower, bathtub, kitchen sink, cleaner sink	15	10

2.3.2 Determination of the draw-off time according to SIA 385/1

The draw-off time consists of two phases:

1. Cold phase: Pipe content is drawn off.
2. Warm-up phase: Pipes, valves and distributors warm up until an effective temperature of 40°C is achieved at the point of use.

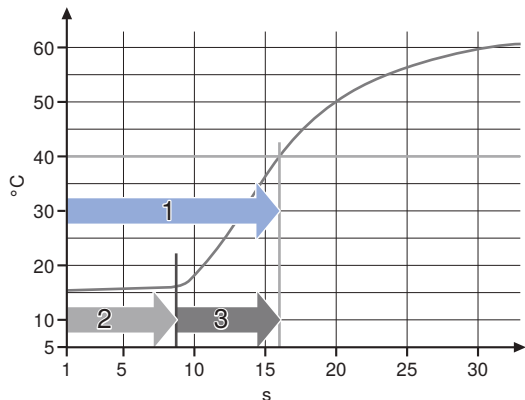

Figure 151: Temperature profile at the point of use when hot water is initially drawn off depending on the effective temperature and time

- 1 Draw-off time
- 2 Cold phase
- 3 Warm-up phase

Calculation of the draw-off time according to SIA 385/1

The cold phase is calculated as follows:

$$\text{Cold phase} = \frac{V \cdot L}{\dot{V}}$$

- V Pipe content [l/m]
- L Pipe length [m]
- \dot{V} Volumetric flow rate [l/s]

The warm-up phase lasts about the same length of time as the cold phase. The cold phase is therefore considered as factor 2 in the calculation of the draw-off time. This factor is not dependent on the pipe material chosen, the pipe diameter or the installation type chosen at a water temperature of at least 55°C in pipes that are kept warm. The draw-off time is therefore calculated as follows:

Draw-off time = cold phase · 2

This results in the following formula, which is used to calculate the draw-off time t:

$$t = \frac{V \cdot L}{\dot{V}} \cdot 2 \quad \left[\frac{\text{m} \cdot \text{l} \cdot \text{s}}{\text{m} \cdot \text{l}} \right]$$

- t Draw-off time [s]
- V Pipe content [l/m]
- L Pipe length [m]
- \dot{V} Volumetric flow rate [l/s]

Sample calculation:

- distribution system: with heat maintenance, e.g. circulation
- sanitary appliance: kitchen sink (2 LU) = 0.2 l/s
- pipe content:
 - discharge pipe: Geberit Mepla d16 mm (0.104 l/m), 8 m = 0.83 l

Required:

- draw-off time t

Solution:

$$t = \frac{0.83}{0.2} \cdot 2 \left[\frac{\text{m} \cdot \text{l} \cdot \text{s}}{\text{m} \cdot \text{l}} \right]$$

$$t = 8.3 \text{ s}$$

The maximum draw-off time of 10 s is not exceeded.

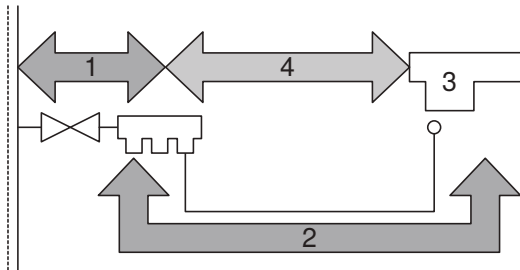

Figure 152: Illustration of sample calculation

- 1 Manifold 3/4"
- 2 Relevant pipe length (discharge pipe)
- 3 Kitchen sink
- 4 Distance from manifold to kitchen sink

Note

If the manifold is not more than 1 m away from the hot pipe and is insulated, this pipe volume must not be included in the calculation.

Relevant pipe length for the calculation of the draw-off time: In the example, the uncoiled pipe length of the discharge pipe is 8.0 m.

In the example, the distance from the manifold to the kitchen sink is about 7 m.

2.4 ASSIGNMENT OF GEBERIT PIPE DIMENSIONS TO NOMINAL WIDTHS

Table 67: Nominal widths DN and corresponding outer diameters d of Geberit supply systems

DN	Geberit Mepla d [mm]	Geberit Mapress d [mm]	Steel pipe d [inches]
10	—	12	3/8
12	16	15	—
15	20	18	1/2
20	26	22	3/4
25	32	28	1
32	40	35	1 1/4
40	50	42	1 1/2
50	63	54	2
65	75	76.1	2 1/2
80	—	88.9	3
100	—	108	4

— Not available

2.5 THERMAL EXPANSION OF PIPES

Pipes expand differently due to thermal effects depending on the material. This thermal expansion is designated as change in length Δl . The higher the temperature differences, the greater also the change in length.

The following affect the change in length:

- material
- ambient conditions
- operating conditions (e.g. media with different temperatures)

The change in length must be taken into account in the planning of the pipe installation.

In the case of pipes that are embedded in concrete in the protective tube or with the corresponding insulation, the thermal expansion is absorbed within the protective tube or insulation. No further measures are therefore required.

The following designs must be taken into account for exposed or concealed installation and when laying pipes in ducts.

The pipes are kept flexible with sliding points.

Anchor points direct the change in length in the desired direction. Suitable measures must be taken to absorb the change in length, depending on the specification of the change in length.

2.5.1 Positioning of anchor points and sliding points

The following rules must be observed for fastening pipes with anchor points (F) and sliding points (GL):

- Anchor or sliding points must not be attached to pressfittings.
- Sliding points must be set so that they do not become unwanted anchor points during operation.

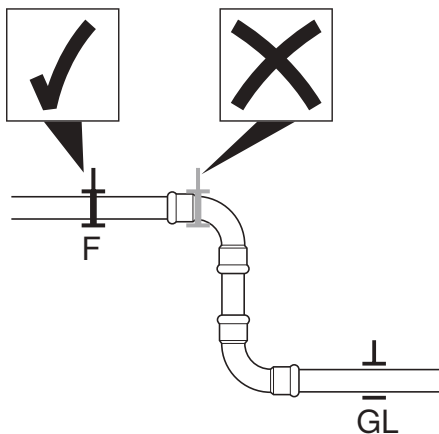

- Sliding points must be positioned so that horizontal pipes can expand.

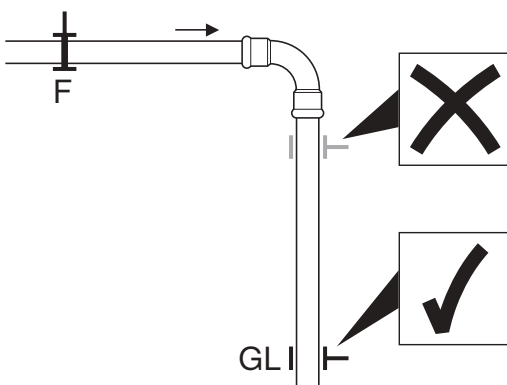

- In the case of branch pipes or changes in direction, the change in length of the deflection leg provides the minimum distance of the first sliding point, see the designs for determining the deflection leg length.
- A pipe run that does not have an expansion compensator (e.g. change in direction, U-bend) may only include one anchor point.

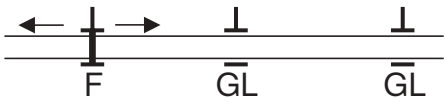

- For long pipe runs (e.g. riser pipes), it is recommended to position an anchor point in the middle of the pipe run. The expansion is therefore routed in two directions and the load on the branch fittings is reduced.
- Branch discharge pipes (e.g. to radiators) must be sufficiently long to accommodate the change in length that occurs in the piping system.

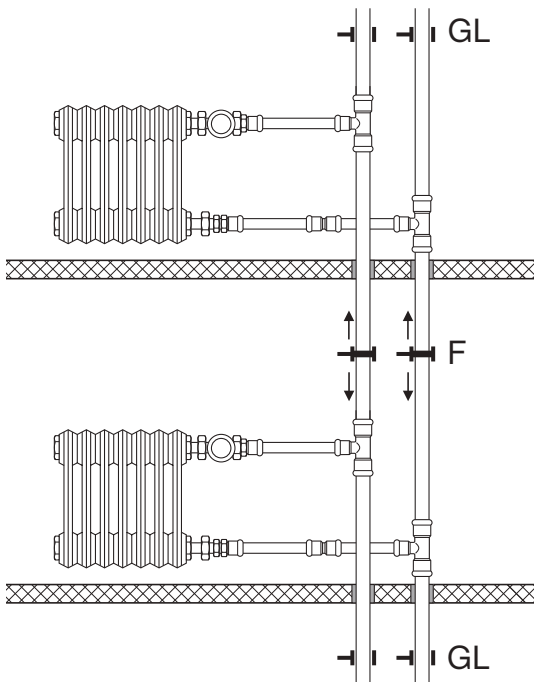

2.6 ABSORPTION OF THE CHANGE IN LENGTH

Temperature-related changes in length Δl can be balanced out with the following measures:

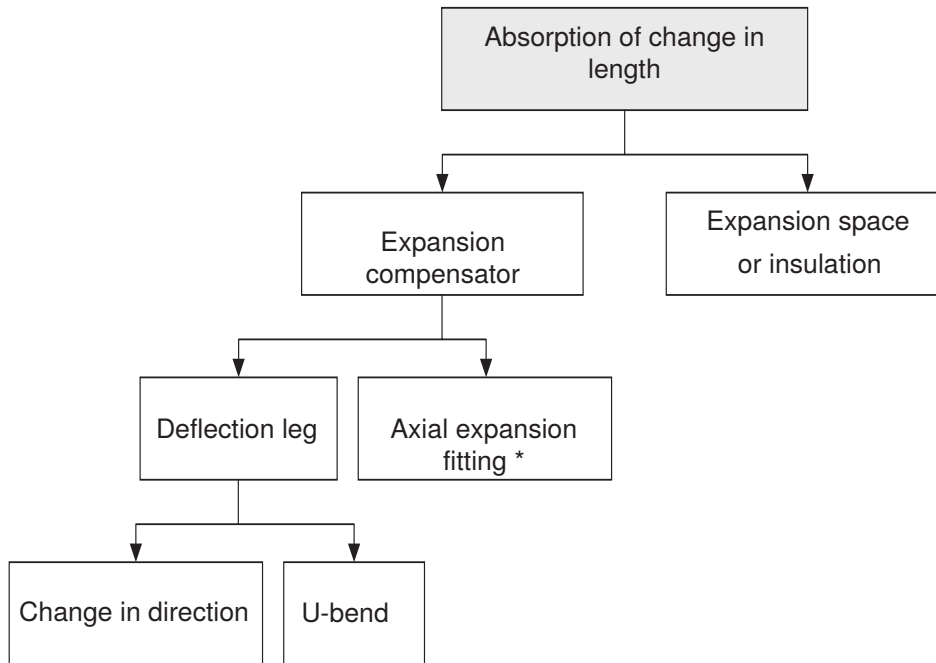

* Only for Geberit Mapress Stainless Steel and Geberit Mapress Carbon Steel

2.6.1 Expansion space or insulation

Slight changes in the length of pipes can be absorbed by means of the elasticity of the piping system or by means of compressible insulation.

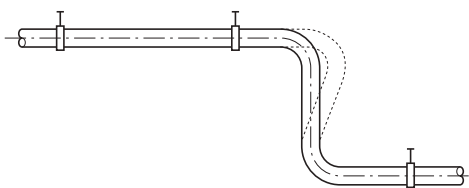

Figure 153: Absorption of a change in length Δl by means of the elasticity of the piping system

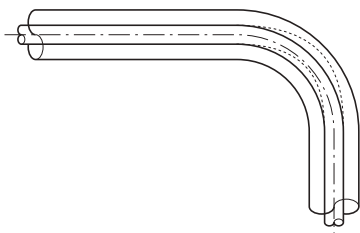

Figure 154: Absorption of a change in length Δl by means of compressible insulation

2.6.2 Deflection legs as an expansion compensator

If the changes in length cannot be balanced out by means of the insulation, then the change in length must be absorbed by an expansion compensator. Deflection legs are a type of expansion compensator. Planning for deflection legs means that no additional costs and maintenance costs are incurred, for example, those that would arise through the installation of axial expansion fittings as an expansion compensator.

Deflection legs can be used if there is a change in direction, for long straight pipes or as a U-bend.

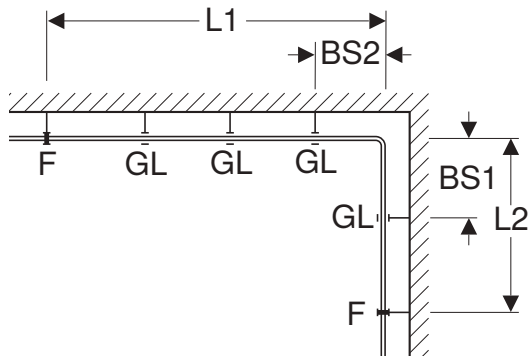

Figure 155: Expansion compensation through change in direction

- BS Deflection leg
- F Anchor point
- GL Sliding point
- L Pipe length

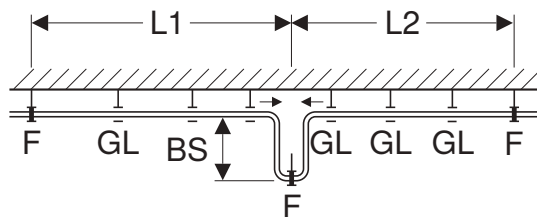

Figure 156: Expansion compensation by a U-bend

- BS Deflection leg
- F Anchor point
- GL Sliding point
- L Pipe length

The longer pipe section (L_1 or L_2) is used as the pipe length L to calculate the deflection leg length in the case of a U-bend.

Deflection legs in rise pipes

In riser pipes over several floors, the thermal expansion is controlled with anchor points. The thermal expansion in several floor connections is absorbed by means of deflection legs. The sliding brackets on horizontal pipes act like anchor points for the thermal expansion of the pipe vertically.

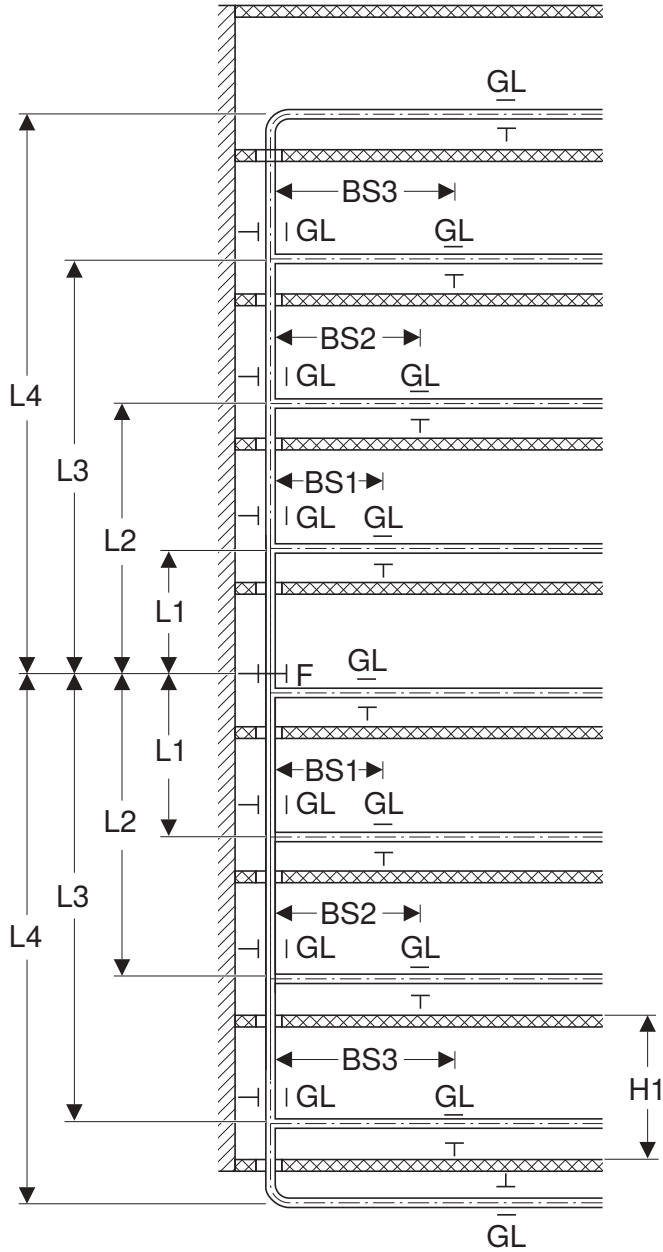

Figure 157: Riser pipe with an anchor point in the middle: control of the thermal expansion upwards and downwards halves the deflection leg length

- F Anchor point
- BS Deflection leg
- GL Sliding point
- L Pipe length
- H1 Floor height

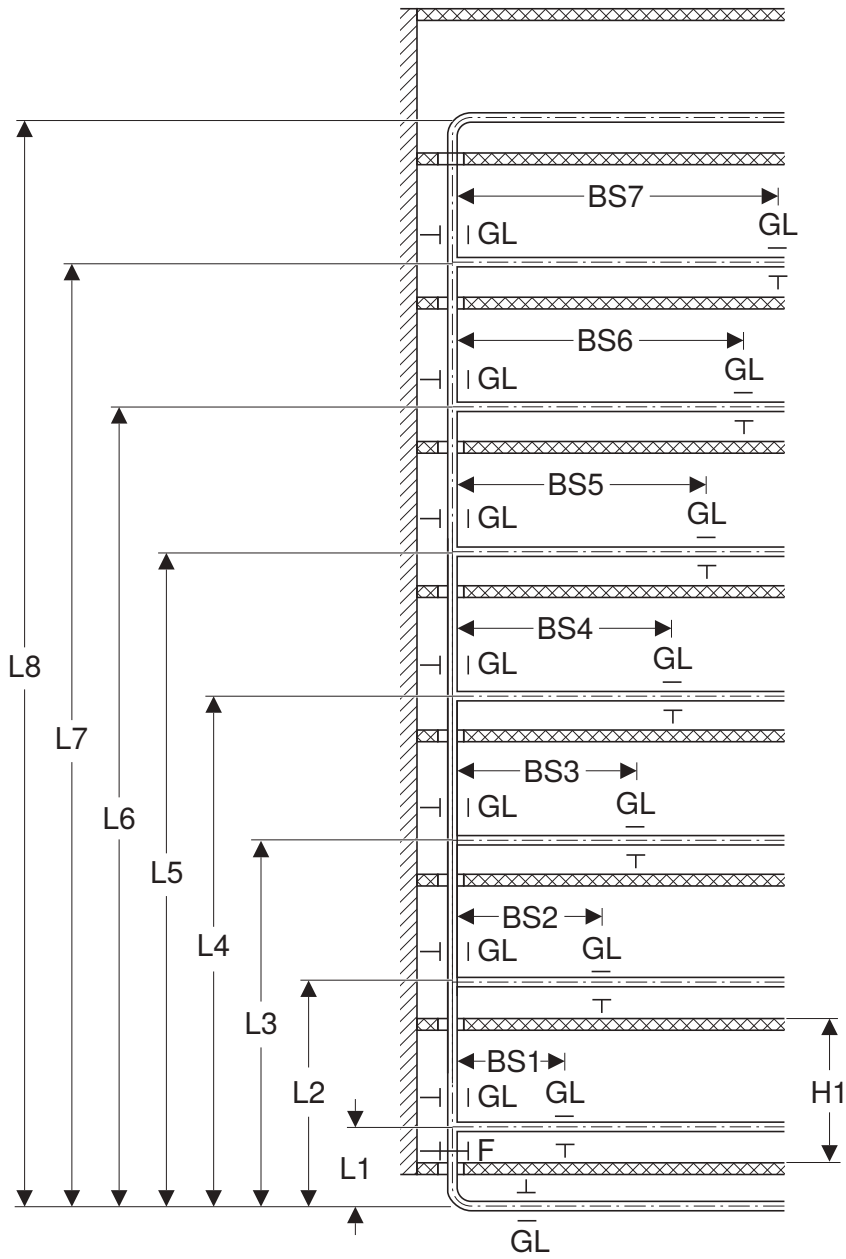

Figure 158: Riser pipe with an anchor point at the bottom: control of the thermal expansion upwards

- F Anchor point
- BS Deflection leg
- GL Sliding point
- L Pipe length
- H1 Floor height

Deflection legs for pipe laying in a duct

If the pipe is laid in a duct, the change in length can be absorbed by deflection legs as follows:

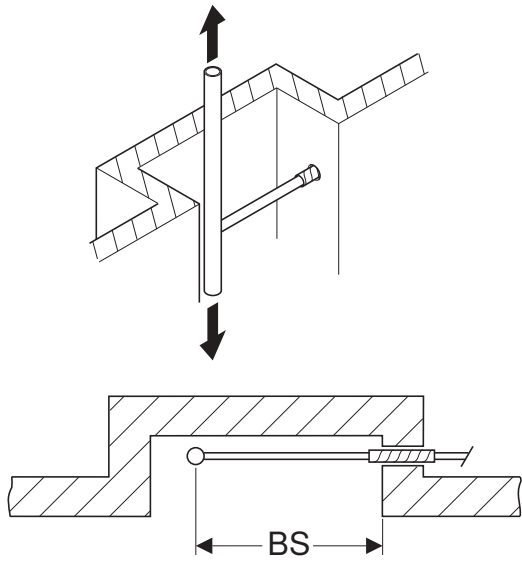

Figure 159: Straight deflection leg, without insulation

BS Deflection leg

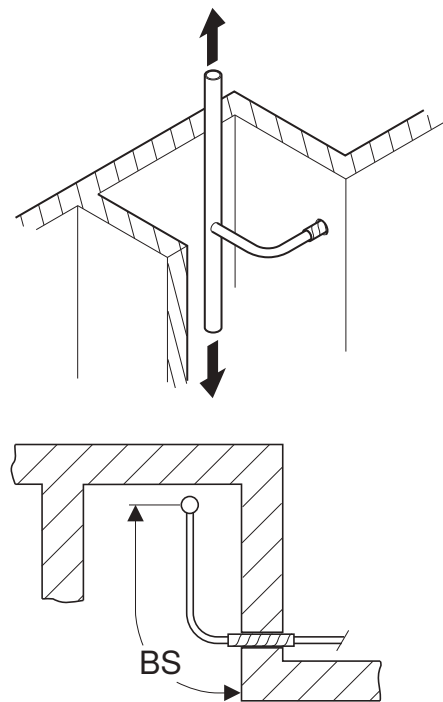

Figure 160: Bent deflection leg, without insulation

BS Deflection leg

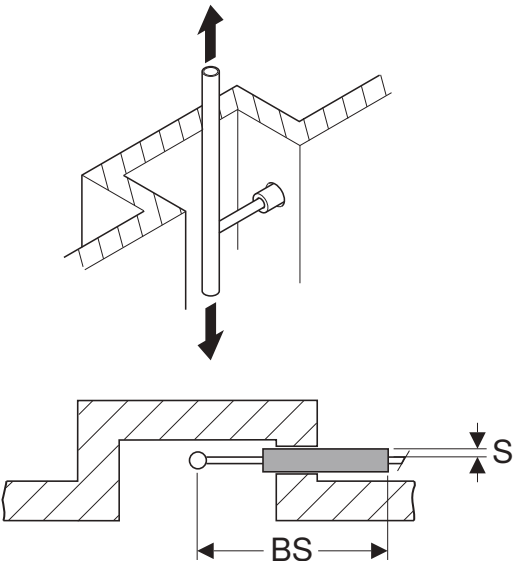

Figure 161: Straight deflection leg, with insulation

- BS Deflection leg
- S Insulation thickness

Determination of the deflection leg length for Mapress Stainless Steel

The thermal expansion of pipes depends on the material, among other things. Expansion caused by material-dependent parameters must be considered when calculating the deflection leg length. The following table lists the parameters for Geberit Mapress Stainless Steel.

Table 68: Material-dependent Geberit Mapress Stainless Steel parameters for calculating the deflection leg length

System pipe	Material	Thermal expansion coefficient α [mm/(m·K)]	Material constant	
			C	U
Stainless Steel 1.4401	CrNiMo steel	0.0165	60	34
Stainless Steel 1.4521	CrMoTi steel	0.0104	42	24
Stainless Steel 1.4301	CrNi steel	0.0160	58	33

C for calculating the deflection leg length L_B (change in direction, branch pipe)

U for calculating the deflection leg length L_U (U-bend)

The calculation of the deflection leg length comprises the following steps:

- Calculation of the change in length Δl
- Calculation of the deflection leg length L_B with a change in direction and branch pipe or calculation of the deflection leg length L_U with U-bends

Calculation of the change in length Δl

The change in length Δl is calculated with the following formula:

$$\Delta l = L \cdot \alpha \cdot \Delta T$$

Δl Change in length [mm]

L Pipe length [m]

ΔT Temperature differential (operating temperature – ambient temperature at the time of installation) [K]

α Thermal expansion coefficient α [mm/(m · K)]

Given:

- material: Stainless Steel 1.4401
- $L=30$ m
- $\alpha = 0.0165$ mm/(m·K)
- $\Delta T = 50$ K

Required:

- Change in length Δl [mm]

Solution:

$$\Delta l = L \cdot \alpha \cdot \Delta T \left[\frac{\text{m} \cdot \text{mm} \cdot \text{K}}{\text{m} \cdot \text{K}} = \text{mm} \right]$$

$$\Delta l = 30 \cdot 0.0165 \cdot 50$$

$$\Delta l = 24.75 \text{ mm}$$

The change in length Δl can also be calculated in a simplified manner from the following table.

Table 69: Change in length Δl [mm] for stainless steel 1.4401/1.4301

L [m]	Temperature differential ΔT [K]									
	10	20	30	40	50	60	70	80	90	100
1	0.17	0.33	0.50	0.66	0.83	0.99	1.16	1.32	1.49	1.65
2	0.33	0.66	0.99	1.32	1.65	1.98	2.31	2.64	2.97	3.30
3	0.50	0.99	1.49	1.98	2.48	2.97	3.47	3.96	4.46	4.95
4	0.66	1.32	1.98	2.64	3.30	3.96	4.62	5.28	5.94	6.60
5	0.83	1.65	2.48	3.30	4.13	4.95	5.78	6.60	7.43	8.25
6	0.99	1.98	2.97	3.96	4.95	5.94	6.93	7.92	8.91	9.90
7	1.16	2.31	3.47	4.62	5.78	6.93	8.09	9.24	10.40	11.55
8	1.32	2.64	3.96	5.28	6.60	7.92	9.24	10.56	11.88	13.20
9	1.49	2.97	4.46	5.94	7.43	8.91	10.40	11.88	13.37	14.85
10	1.65	3.30	4.95	6.60	8.25	9.90	11.55	13.20	14.85	16.50
20	3.30	6.60	9.90	13.20	16.50	19.80	23.10	26.40	29.70	33.00
30	4.95	9.90	14.85	19.80	24.75	29.70	34.65	39.60	44.55	49.00
40	6.60	13.20	19.80	26.40	33.00	39.60	46.20	52.80	59.40	66.00
50	8.25	16.50	24.75	33.00	41.25	49.50	57.75	66.00	74.25	82.50

L Pipe length

Table 70: Change in length Δl [mm] for stainless steel 1.4521

L [m]	Temperature differential ΔT [K]									
	10	20	30	40	50	60	70	80	90	100
1	0.10	0.21	0.31	0.42	0.52	0.62	0.73	0.83	0.94	1.04
2	0.21	0.42	0.62	0.83	1.04	1.25	1.46	1.66	1.87	2.08
3	0.31	0.62	0.94	1.25	1.56	1.87	2.18	2.50	2.81	3.12
4	0.42	0.83	1.25	1.66	2.08	2.50	2.91	3.33	3.74	4.16
5	0.52	1.04	1.56	2.08	2.60	3.12	3.64	4.16	4.68	5.20
6	0.62	1.25	1.87	2.50	3.12	3.74	4.37	4.99	5.62	6.24
7	0.73	1.46	2.18	2.91	3.64	4.37	5.10	5.82	6.55	7.28
8	0.83	1.66	2.50	3.33	4.16	4.99	5.82	6.66	7.49	8.32
9	0.94	1.87	2.81	3.74	4.68	5.62	6.55	7.49	8.42	9.36
10	1.04	2.08	3.12	4.16	5.20	6.24	7.28	8.32	9.36	10.40
20	2.08	4.16	6.24	8.32	10.40	12.48	14.56	16.64	18.72	20.80
30	3.12	6.24	9.36	12.48	15.60	18.72	21.84	24.96	28.08	31.20
40	4.16	8.32	12.48	16.64	20.80	24.96	29.12	33.28	37.44	41.60
50	5.20	10.40	15.60	20.80	26.00	31.20	36.40	41.60	46.80	52.00

L Pipe length

Calculation of the deflection leg length with a change in direction and branch pipe

The deflection leg length L_B to be calculated is defined as follows with changes in direction and branch pipes:

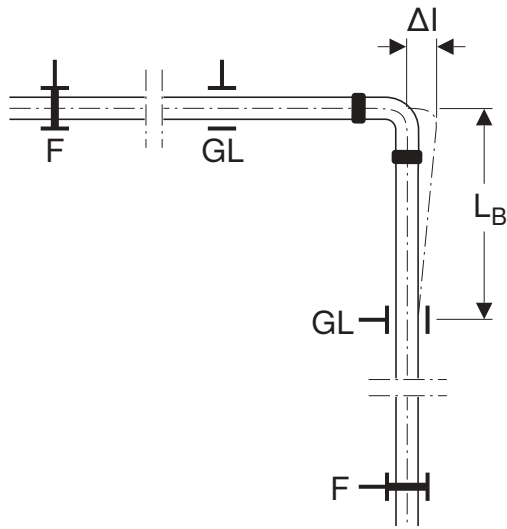

Figure 162: Expansion compensation with a change in direction

- F Anchor point
- GL Sliding point
- L_B Deflection leg length
- Δl Change in length

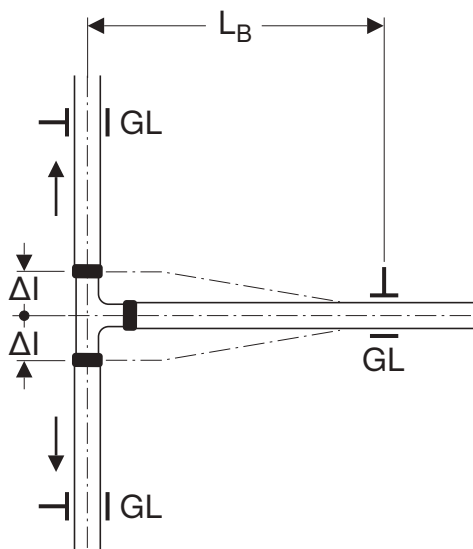

Figure 163: Expansion compensation with a branch pipe

- GL Sliding point
- L_B Deflection leg length
- Δl Change in length

The deflection leg length L_B is calculated using the following formula:

$$L_B = \frac{C \cdot \sqrt{d \cdot \Delta l}}{1000}$$

- L_B Deflection leg length [m]
- d Outer pipe diameter [mm]
- Δl Change in length [mm]
- C Material constant

Given:

- material: Stainless Steel 1.4401
- $C = 60$
- $d = 54$ mm
- $\Delta l = 28.88$ mm

Required:

- L_B [m]

Solution:

$$L_B = \frac{C \cdot \sqrt{d \cdot \Delta l}}{1000} \left[\frac{\sqrt{\text{mm} \cdot \text{mm}}}{\frac{\text{mm}}{\text{m}}} = \text{m} \right]$$

$$L_B = \frac{60 \cdot \sqrt{54 \cdot 28.88}}{1000}$$

$$L_B = 2.37 \text{ m}$$

The deflection leg length L_B can also be calculated in a simplified manner from the following graphics:

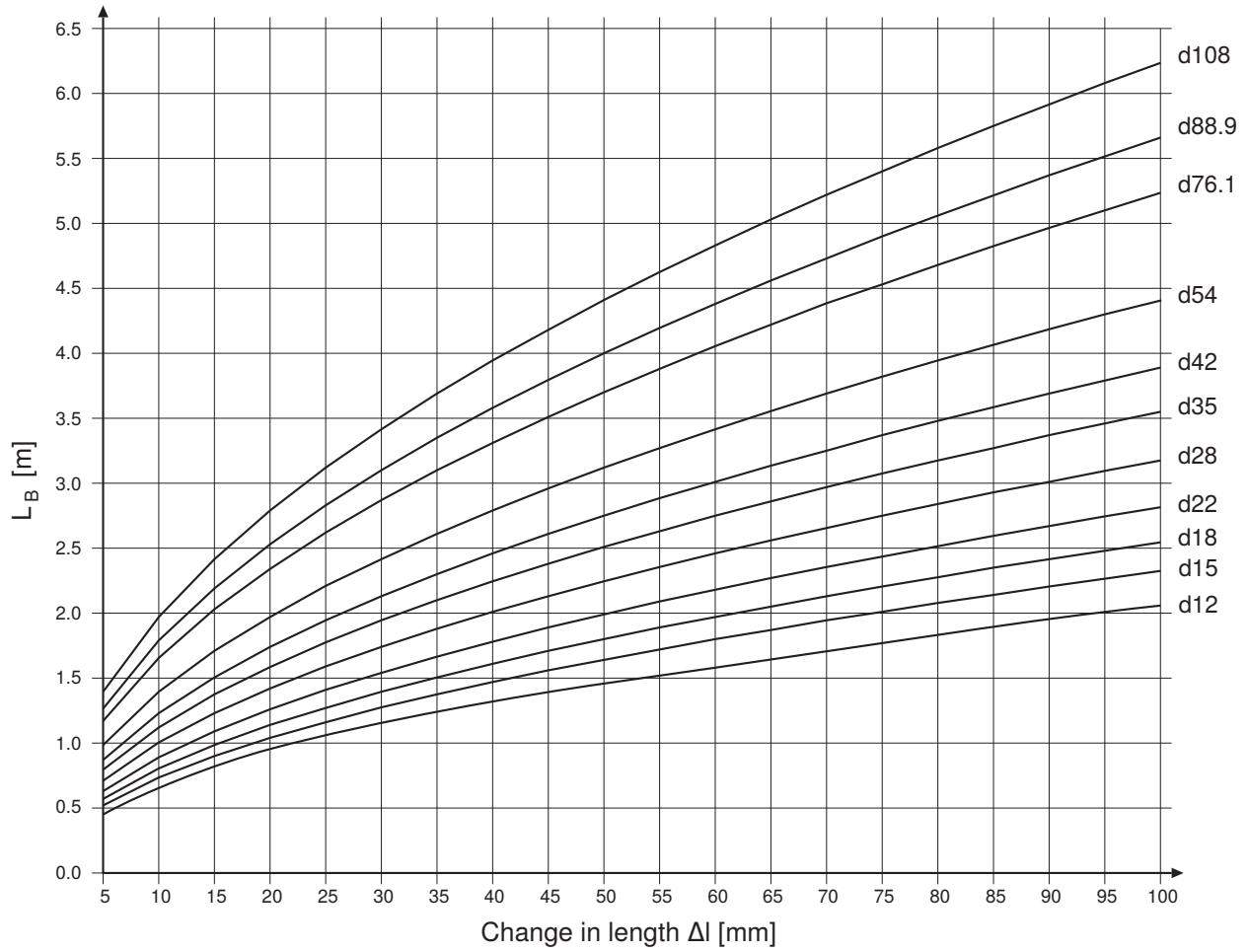

Figure 164: Deflection leg length L_B , stainless steel 1.4401

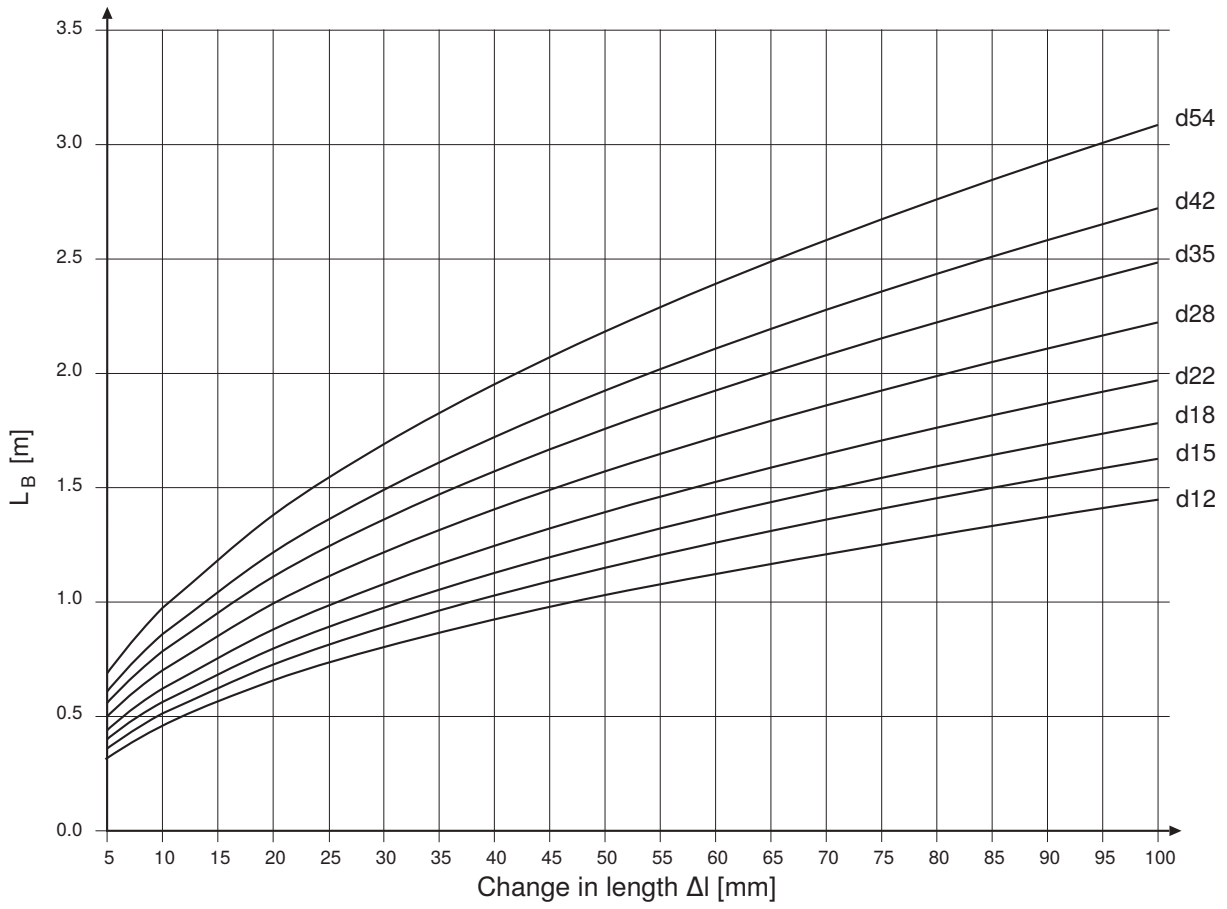

Figure 165: Deflection leg length L_B , stainless steel 1.4521

Calculation of the deflection leg length for U-bends

The deflection leg length L_U to be calculated is defined as follows:

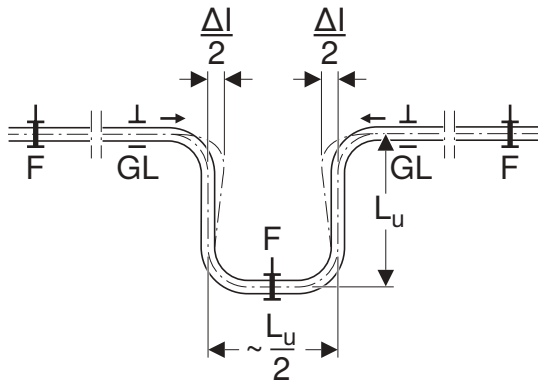

Figure 166: U-bend, made of bent pipe

- F Anchor point
- GL Sliding point
- L_U Deflection leg length
- Δl Change in length

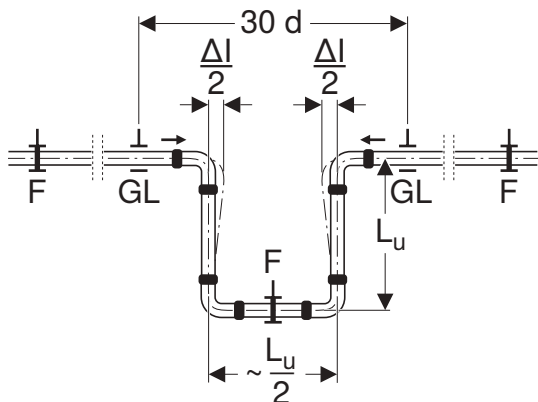

Figure 167: U-bend, made with pressfittings

- F Anchor point
- GL Sliding point
- L_U Deflection leg length
- Δl Change in length

The deflection leg length L_U is calculated using the following formula:

$$L_U = \frac{U \cdot \sqrt{d \cdot \Delta l}}{1000}$$

- L_U Deflection leg length [m]
- d Outer pipe diameter [mm]
- Δl Change in length [mm]
- U Material constant

Given:

- material: Stainless Steel 1.4401
- $U=34$
- $d = 54 \text{ mm}$
- $\Delta l = 28.88 \text{ mm}$

Required:

- $L_U \text{ [m]}$

Solution:

$$L_U = \frac{U \cdot \sqrt{d \cdot \Delta l}}{1000} \left[\frac{\sqrt{\text{mm} \cdot \text{mm}}}{\frac{\text{mm}}{\text{m}}} = \text{m} \right]$$

$$L_U = \frac{34 \cdot \sqrt{54 \cdot 28.88}}{1000}$$

$$L_U = 1.34 \text{ m}$$

The deflection leg length L_U can also be calculated in a simplified manner from the following graphics:

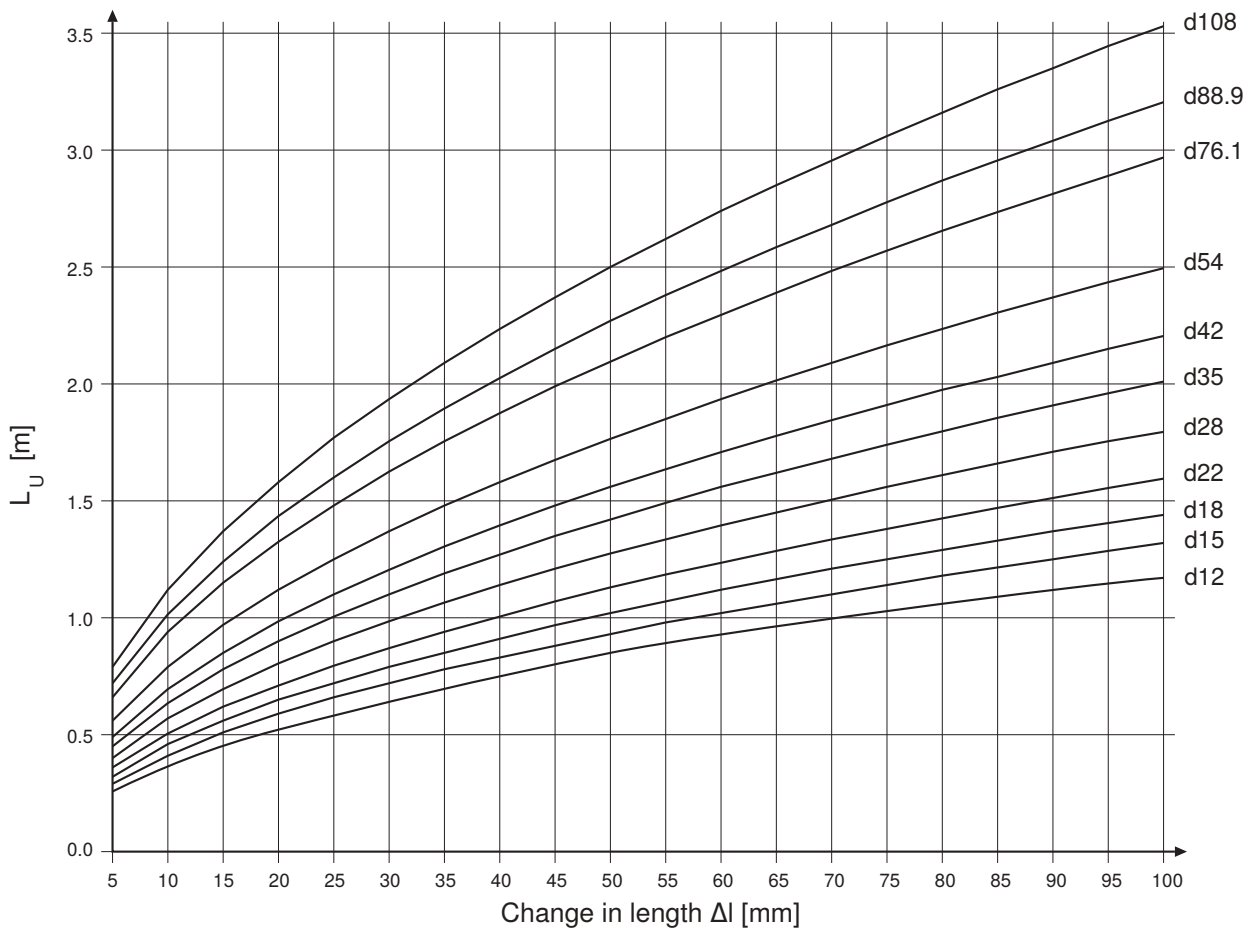

Figure 168: Deflection leg length L_U , stainless steel 1.4401

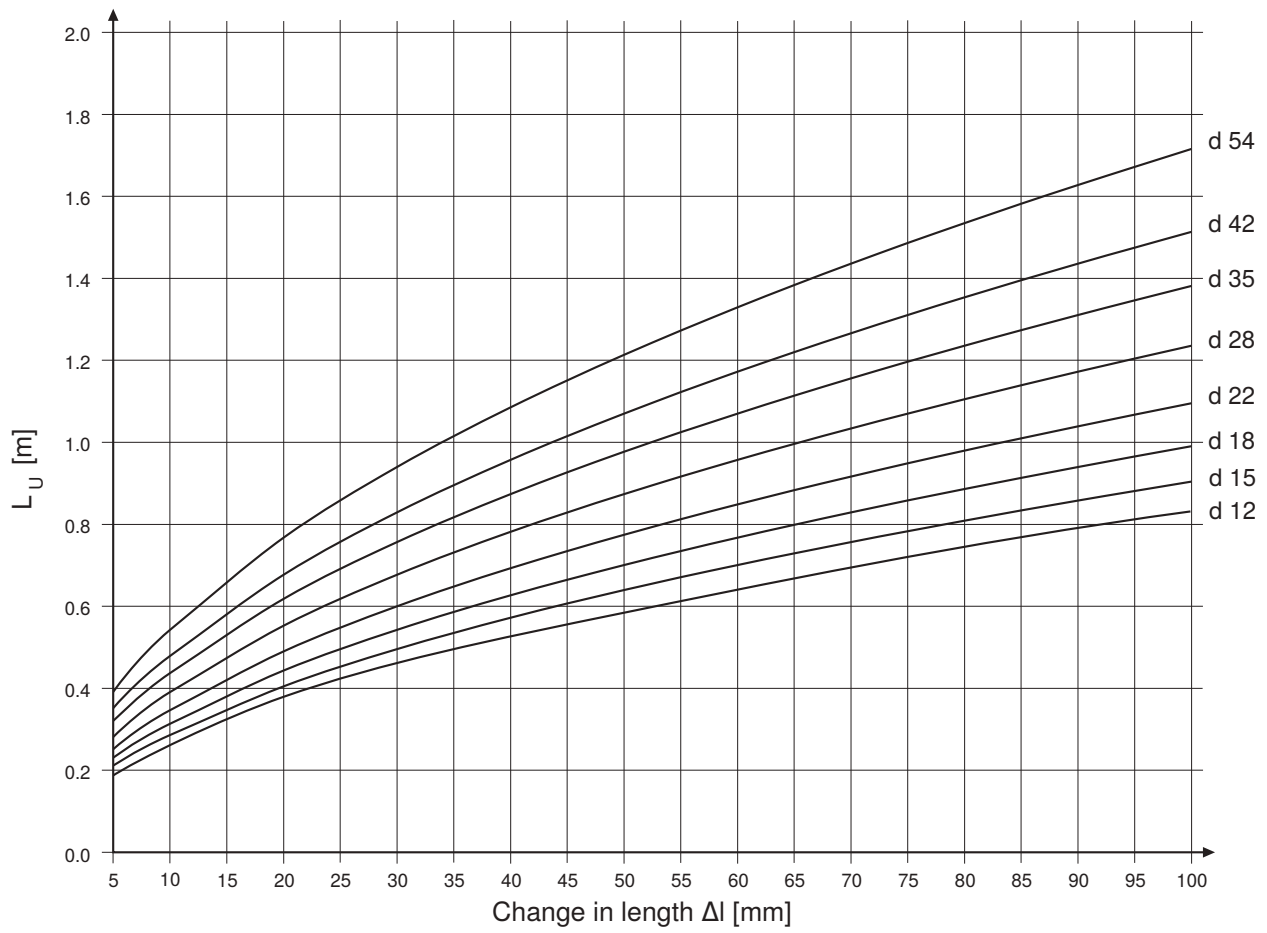

Figure 169: Deflection leg length L_u , stainless steel 1.4521

Calculation of the deflection leg length for Mapress Carbon Steel

The thermal expansion of pipes depends on the material, among other things. Material-dependent parameters must be considered when calculating the deflection leg length. The following table lists the parameters for Geberit Mapress Carbon Steel.

Table 71: Material-dependent Geberit Mapress Carbon Steel parameters for calculating the deflection leg length

System pipe	Material	Thermal expansion coefficient α [mm/(m·K)]	Material constant	
			C	U
Geberit Mapress Carbon Steel 1.0034	Non-alloy steel	0.012	55	31

C for calculating the deflection leg length L_B (change in direction, branch pipe)

U for calculating the deflection leg length L_U (U-bend)

The calculation of the deflection leg length comprises the following steps:

- Calculation of the change in length Δl
- Calculation of the deflection leg length L_B with a change in direction and branch pipe or calculation of the deflection leg length L_U with U-bends.

Calculation of the change in length Δl

The change in length Δl is calculated using the following formula:

$$\Delta l = L \cdot \alpha \cdot \Delta T$$

Δl Change in length [mm]

L Pipe length [m]

ΔT Temperature differential (operating temperature - ambient temperature at time of installation) [K]

α Thermal expansion coefficient α [mm/(m · K)]

Given:

- material: Mapress Carbon Steel
- L = 30 m
- $\alpha = 0.012$ mm/(m·K)
- $\Delta T = 50$ K

Required:

- change in length Δl [mm]

Solution:

$$\Delta l = L \cdot \alpha \cdot \Delta T \left[\frac{\text{m} \cdot \text{mm} \cdot \text{K}}{\text{m} \cdot \text{K}} = \text{mm} \right]$$

$$\Delta l = 30 \cdot 0.012 \cdot 50$$

$$\Delta l = 18 \text{ mm}$$

The change in length Δl can also be calculated in a simplified manner from the following table.

Table 72: Change in length Δl in mm for Geberit Mapress Carbon Steel system pipes

L [m]	Temperature differential ΔT [K]									
	10	20	30	40	50	60	70	80	90	100
1	0.12	0.24	0.36	0.48	0.60	0.72	0.84	0.96	1.08	1.20
2	0.24	0.48	0.72	0.96	1.20	1.44	1.68	1.92	2.16	2.40
3	0.36	0.72	1.08	1.44	1.80	2.16	2.52	2.88	3.24	3.60
4	0.48	0.96	1.44	1.92	2.40	2.88	3.36	3.84	4.32	4.80
5	0.60	1.20	1.80	2.40	3.00	3.60	4.20	4.80	5.40	6.00
6	0.72	1.44	2.16	2.88	3.60	4.32	5.04	5.76	6.48	7.20
7	0.84	1.68	2.52	3.36	4.20	5.04	5.88	6.72	7.56	8.40
8	0.96	1.92	2.88	3.84	4.80	5.76	6.72	7.68	8.64	9.60
9	1.08	2.16	3.24	4.32	5.40	6.48	7.56	8.64	9.72	10.80
10	1.20	2.40	3.60	4.80	6.00	7.20	8.40	9.60	10.80	12.00
20	2.40	4.80	7.20	9.60	12.00	14.40	16.80	19.20	21.60	24.00
30	3.60	7.20	10.80	14.40	18.00	21.60	25.20	28.80	32.40	36.00
40	4.80	9.60	14.40	19.20	24.00	28.80	33.60	38.40	43.20	48.00
50	6.00	12.00	18.00	24.00	30.00	36.00	42.00	48.00	54.00	60.00

L Pipe length

Calculation of the deflection leg length with a change in direction and branch pipe

The deflection leg length L_b to be calculated is defined as follows with changes in direction and branch pipes:

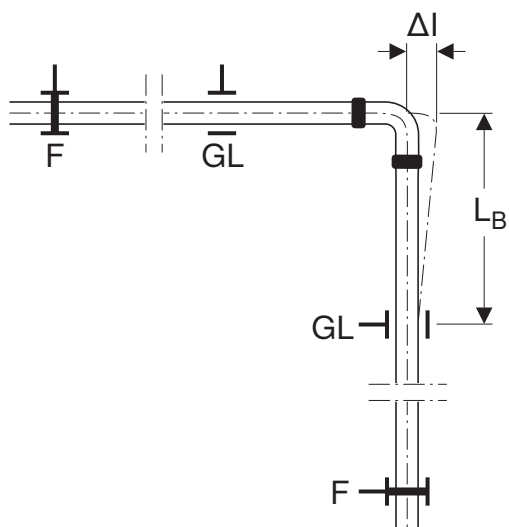

Figure 170: Expansion compensation with a change in direction

- F Anchor point
- GL Sliding point
- L_b Deflection leg length
- Δl Change in length

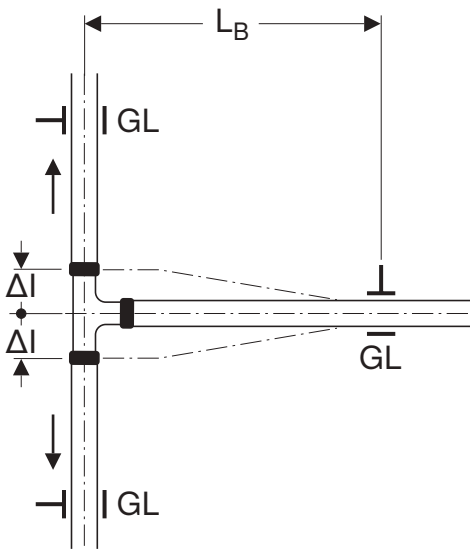

Figure 171: Expansion compensation with branch pipe

- GL Sliding point
- L_B Deflection leg length
- Δl Change in length

The deflection leg length L_B is calculated using the following formula:

$$L_B = \frac{C \cdot \sqrt{d \cdot \Delta l}}{1000}$$

- L_B Deflection leg length [m]
- d Outer pipe diameter [mm]
- Δl Change in length [mm]
- C Material constant

Given:

- material: Mapress Carbon Steel
- $C = 55$
- $d = 54 \text{ mm}$
- $\Delta l = 21 \text{ mm}$

Required:

- L_B [m]

Solution:

$$L_B = \frac{C \cdot \sqrt{d \cdot \Delta l}}{1000} \left[\frac{\sqrt{\text{mm} \cdot \text{mm}}}{\frac{\text{mm}}{\text{m}}} = \text{m} \right]$$

$$L_B = \frac{55 \cdot \sqrt{54 \cdot 21}}{1000} \text{ m}$$

$$L_B = 1.98 \text{ m}$$

The deflection leg length L_B can also be calculated in a simplified manner from the following graphics:

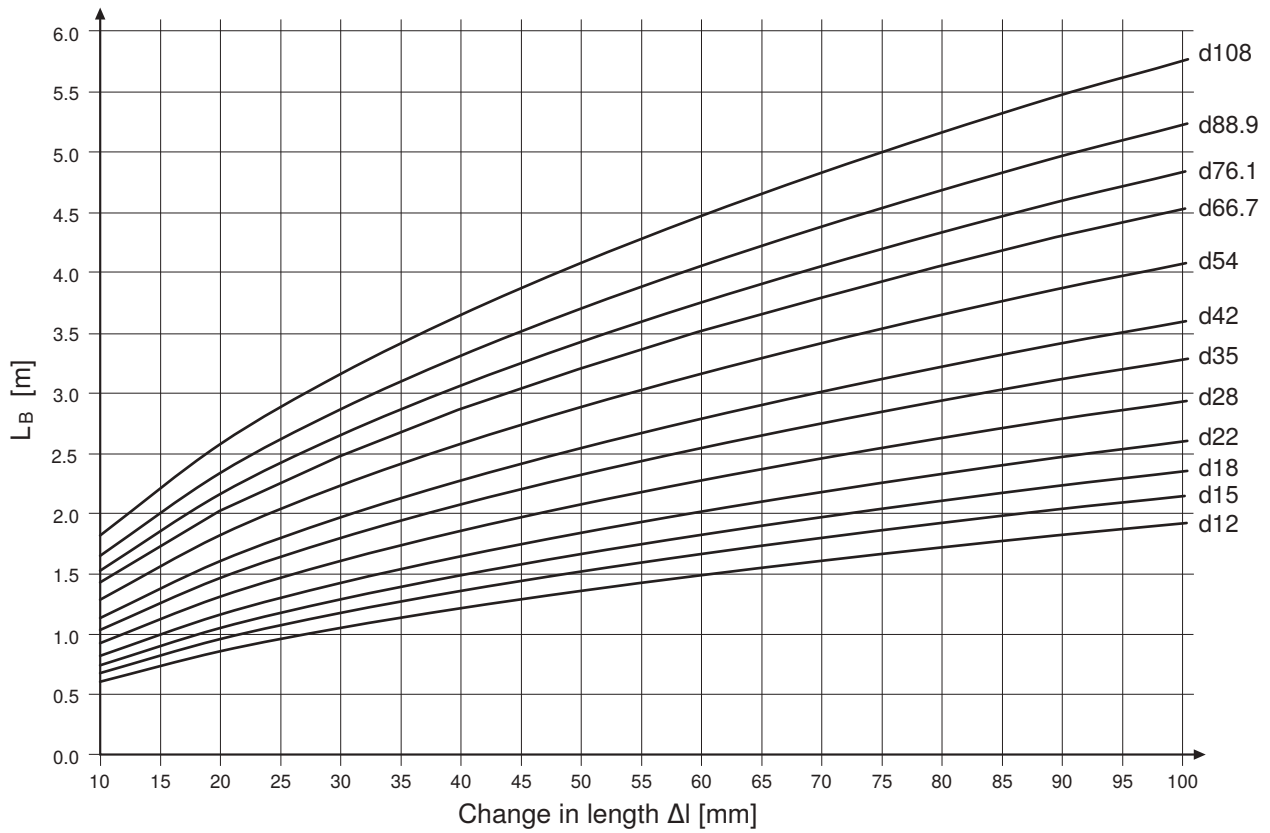

Figure 172: Deflection leg length L_B , Geberit Mapress Carbon Steel

Calculation of the deflection leg length for U-bends

The deflection leg length L_U to be calculated is defined as follows:

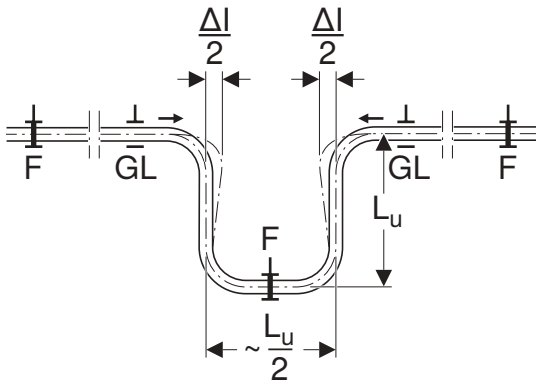

Figure 173: U-bend, made of bent pipe

- F Anchor point
- GL Sliding point
- L_U Deflection leg length
- Δl Change in length

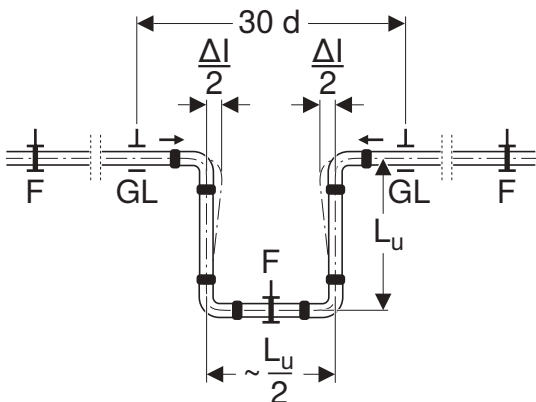

Figure 174: U-bend, made with pressfittings

- F Anchor point
- GL Sliding point
- L_U Deflection leg length
- Δl Change in length

The deflection leg length L_U is calculated using the following formula:

$$L_U = \frac{U \cdot \sqrt{d \cdot \Delta l}}{1000}$$

- L_U Deflection leg length [m]
- d Outer pipe diameter [mm]
- Δl Change in length [mm]
- U Material constant

PRACTICAL USE ABSORPTION OF THE CHANGE IN LENGTH

Given:

- material: Mapress Carbon Steel
- U=31
- d = 54 mm
- Δl = 21 mm

Required:

- L_U [m]

Solution:

$$L_U = \frac{U \cdot \sqrt{d \cdot \Delta l}}{1000} \left[\frac{\sqrt{\text{mm} \cdot \text{mm}}}{\frac{\text{mm}}{\text{m}}} = \text{m} \right]$$

$$L_U = \frac{31 \cdot \sqrt{54 \cdot 21}}{1000}$$

$$L_U = 1.04 \text{ m}$$

The deflection leg length L_U can also be calculated in a simplified manner from the following graphics:

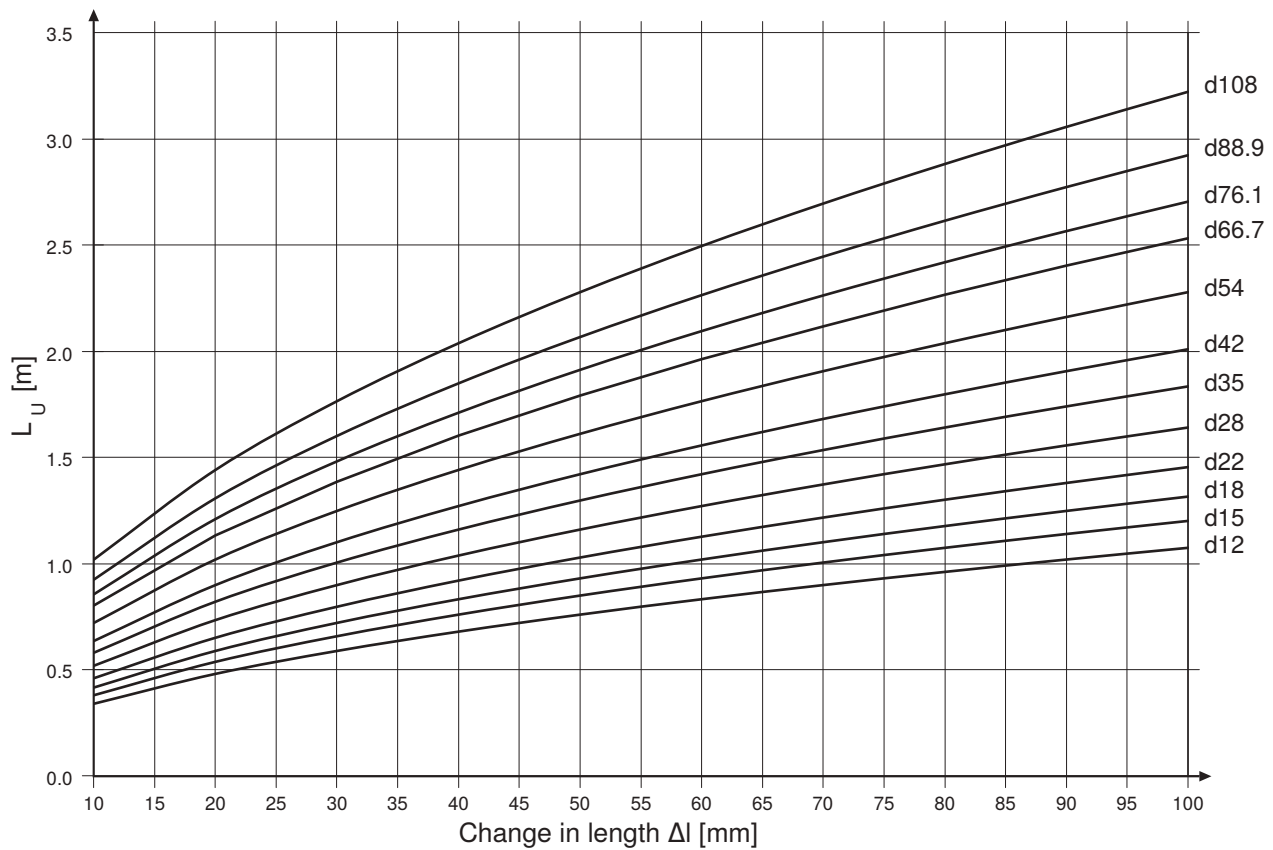

Figure 175: Deflection leg length L_U, Geberit Mapress Carbon Steel

Determination of the deflection leg length for Mapress Copper

The thermal expansion of pipes depends on the material, among other things. Material-dependent parameters must be considered when calculating the deflection leg length. The following table lists the parameters for Geberit Mapress Copper.

Table 73: Material-dependent parameters for determining the deflection leg length for Geberit Mapress Copper

Pipe material	System pipe	Thermal expansion coefficient α [mm/(m·K)]	Material constant	
			C	U
Copper	Geberit Mapress Copper	0.0166	52	29

C for calculating the deflection leg length L_B (change in direction, branch pipe)

U for calculating the deflection leg length L_U (U-bend)

The calculation of the deflection leg length comprises the following steps:

- Calculation of the change in length Δl
- Calculation of the deflection leg length L_B with a change in direction and branch pipe or calculation of the deflection leg length L_U with U-bends.

Calculation of the change in length Δl

The change in length is calculated using the following formula:

$$\Delta l = L \cdot \alpha \cdot \Delta T$$

Δl Change in length [mm]

L Pipe length [m]

ΔT Temperature differential (operating temperature – ambient temperature at the time of installation) [K]

α Thermal expansion coefficient α [mm/(m · K)]

Given:

- material: Copper
- L=30 m
- $\alpha = 0.0166 \text{ mm}/(\text{m}\cdot\text{K})$
- $\Delta T = 50 \text{ K}$

Required:

- Change in length Δl [mm]

Solution:

$$\Delta l = L \cdot \alpha \cdot \Delta T \left[\frac{\text{m} \cdot \text{mm} \cdot \text{K}}{\text{m} \cdot \text{K}} = \text{mm} \right]$$

$$\Delta l = 30 \cdot 0.0166 \cdot 50$$

$$\Delta l = 24.9 \text{ mm}$$

The change in length Δl can also be calculated in a simplified manner from the following tables.

Table 74: Change in length Δl in mm for copper pipes

L [m]	Temperature differential ΔT [K]									
	10	20	30	40	50	60	70	80	90	100
1	0.1	0.3	0.5	0.7	0.8	1.0	1.2	1.3	1.5	1.7
2	0.3	0.7	1.0	1.3	1.7	2.0	2.3	2.7	3.0	3.3
3	0.5	1.0	1.5	2.0	2.5	3.0	3.5	4.0	4.5	5.0
4	0.7	1.3	2.0	2.7	3.3	4.0	4.7	5.3	6.0	6.6
5	0.8	1.7	2.5	3.3	4.2	5.0	5.8	6.6	7.5	8.3
6	1.0	2.0	3.0	4.0	5.0	6.0	7.0	8.0	9.0	10.0
7	1.2	2.3	3.5	4.6	5.8	7.0	8.1	9.3	10.5	11.6
8	1.3	2.7	4.0	5.3	6.6	8.0	9.3	10.6	12.0	13.3
9	1.5	3.0	4.5	6.0	7.5	9.0	10.5	12.0	13.5	15.0
10	1.7	3.3	5.0	6.6	8.3	10.0	11.6	13.3	14.9	16.6
20	3.3	6.6	10.0	13.3	16.6	19.9	23.2	26.6	29.9	33.2
30	5.0	10.0	14.9	19.9	24.9	29.9	34.9	39.8	44.8	49.8
40	6.6	13.3	19.9	26.6	33.2	39.8	46.5	53.1	59.8	66.4
50	8.3	16.6	24.9	33.2	41.5	49.8	58.1	66.4	74.7	83.0

Calculation of the deflection leg length with a change in direction and branch pipe

The deflection leg length L_B to be calculated is defined as follows with change in direction and for branch pipes:

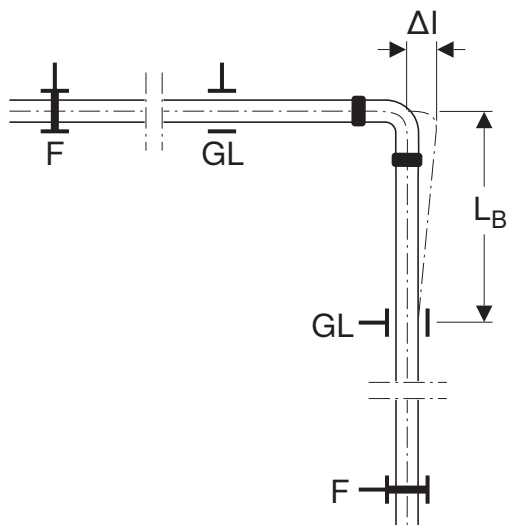

Figure 176: Expansion compensation with a change in direction

- F Anchor point
- GL Sliding point
- L_B Deflection leg length
- Δl Change in length

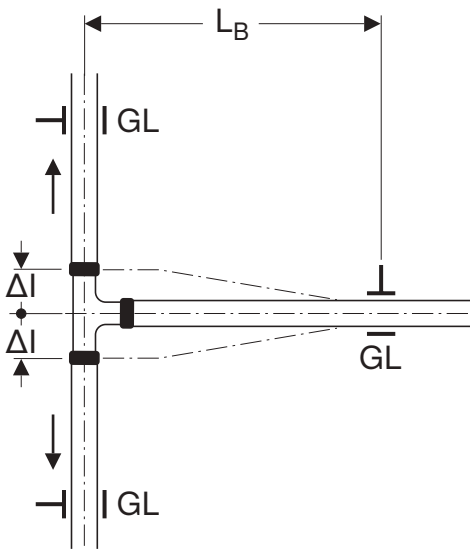

Figure 177: Expansion compensation for branch pipe

- GL Sliding point
- L_B Deflection leg length
- Δl Change in length

The deflection leg length L_B is calculated using the following formula:

$$L_B = \frac{C \cdot \sqrt{d \cdot \Delta l}}{1000}$$

- L_B Deflection leg length [m]
- d Outer pipe diameter [mm]
- Δl Change in length [mm]
- C Material constant

Given:

- material: Copper
- $C = 52$
- $d = 54 \text{ mm}$
- $\Delta l = 29.1 \text{ mm}$

Required:

- L_B [m]

Solution:

$$L_B = \frac{C \cdot \sqrt{d \cdot \Delta l}}{1000} \left[\frac{\sqrt{\text{mm} \cdot \text{mm}}}{\frac{\text{mm}}{\text{m}}} = \text{m} \right]$$

$$L_B = \frac{52 \cdot \sqrt{54 \cdot 29.1}}{1000} \text{ m}$$

$$L_B = 2.06 \text{ m}$$

The deflection leg length L_B can also be calculated in a simplified manner from the following graphics:

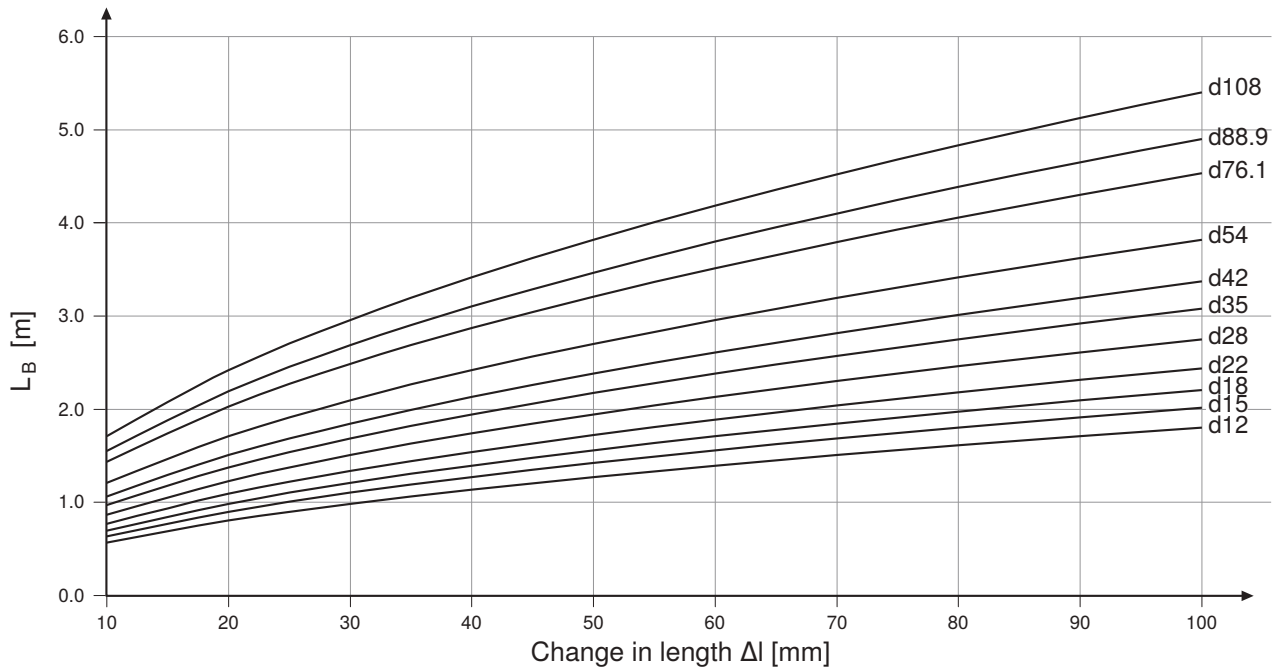

Figure 178: Deflection leg length L_B , copper pipes according to DVGW GW 392:2015-04

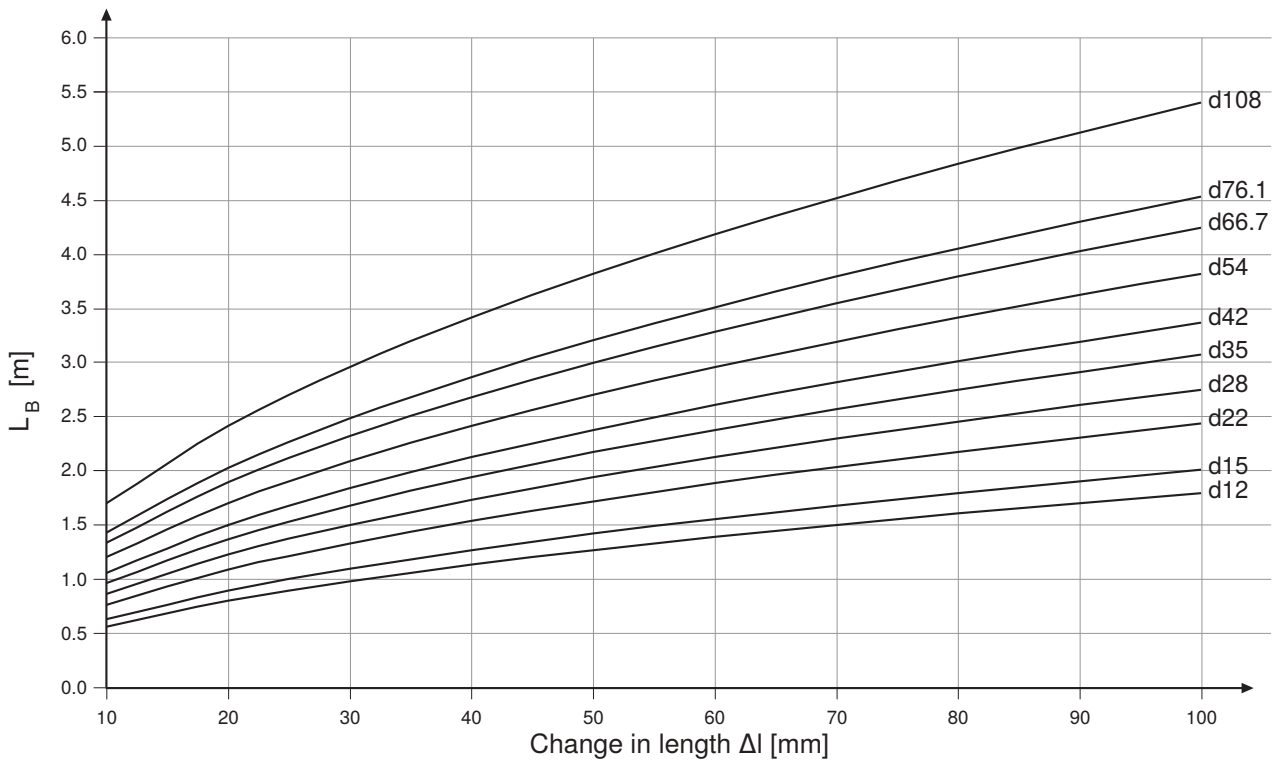

Figure 179: Deflection leg length L_B , copper pipes according to EN 1057

Calculation of the deflection leg length for U-bends

The deflection leg length L_U to be calculated is defined as follows:

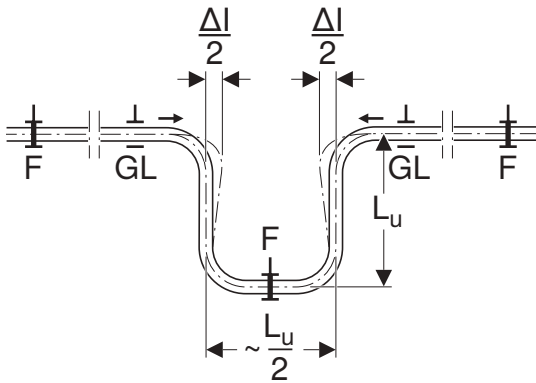

Figure 180: U-bend, made of bent pipe

- F Anchor point
- GL Sliding point
- L_U Deflection leg length
- Δl Change in length

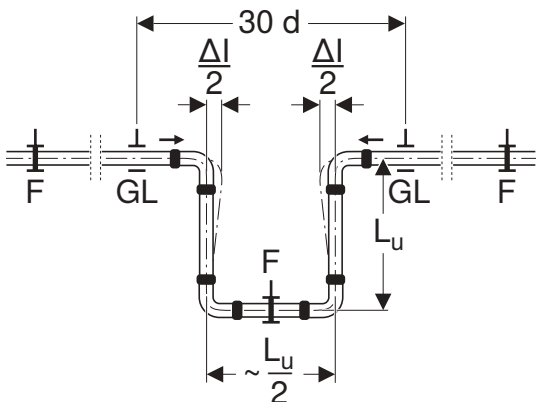

Figure 181: U-bend, made with pressfittings

- F Anchor point
- GL Sliding point
- L_U Deflection leg length
- Δl Change in length

The deflection leg length L_U is calculated using the following formula:

$$L_U = \frac{U \cdot \sqrt{d \cdot \Delta l}}{1000}$$

- L_U Deflection leg length [m]
- d Outer pipe diameter [mm]
- Δl Change in length [mm]
- U Material constant

PRACTICAL USE ABSORPTION OF THE CHANGE IN LENGTH

Given:

- material: Copper
- $U=29$
- $d = 54 \text{ mm}$
- $\Delta l = 29.1 \text{ mm}$

Required:

- $L_U \text{ [m]}$

Solution:

$$L_U = \frac{U \cdot \sqrt{d \cdot \Delta l}}{1000} \left[\frac{\sqrt{\text{mm} \cdot \text{mm}}}{\frac{\text{mm}}{\text{m}}} = \text{m} \right]$$

$$L_U = \frac{29 \cdot \sqrt{54 \cdot 29.1}}{1000} \text{ m}$$

$$L_U = 1.15 \text{ m}$$

The deflection leg length L_U can also be calculated in a simplified manner from the following graphics:

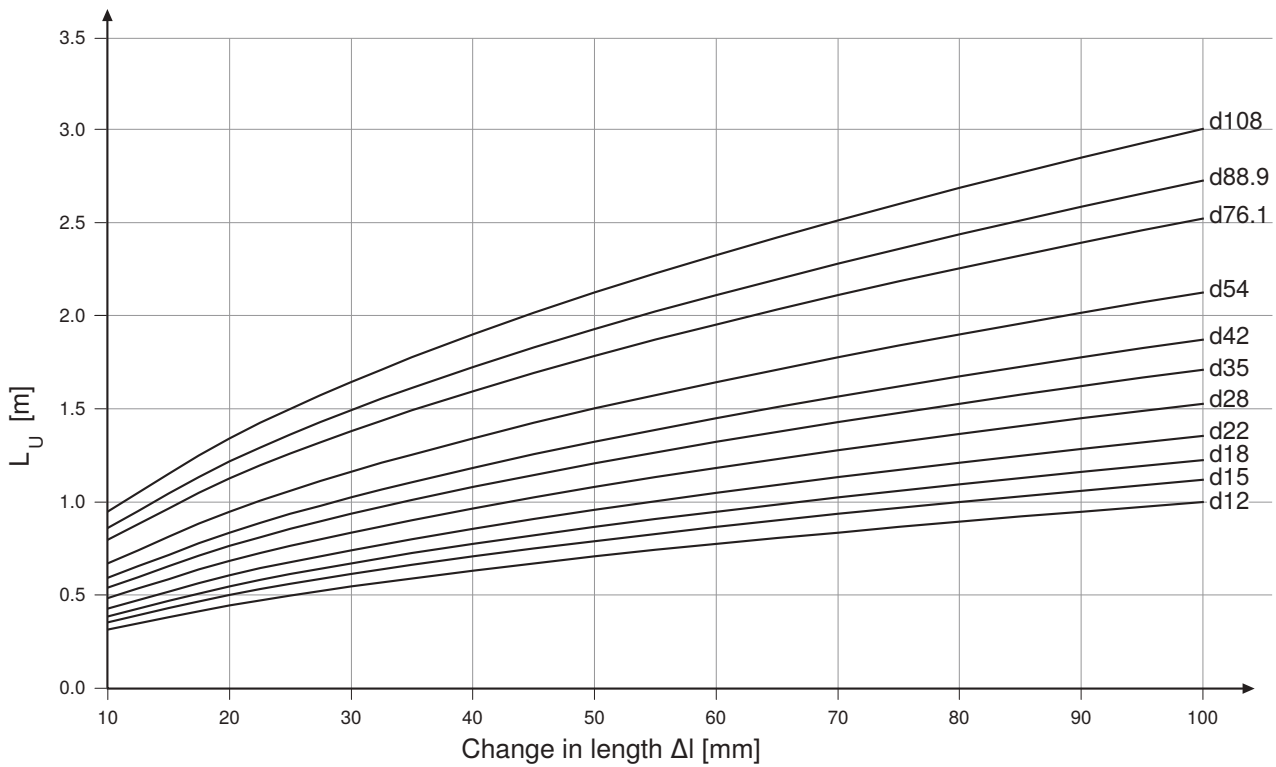

Figure 182: Deflection leg length L_U , copper pipes according to DVGW GW 392:2015-04

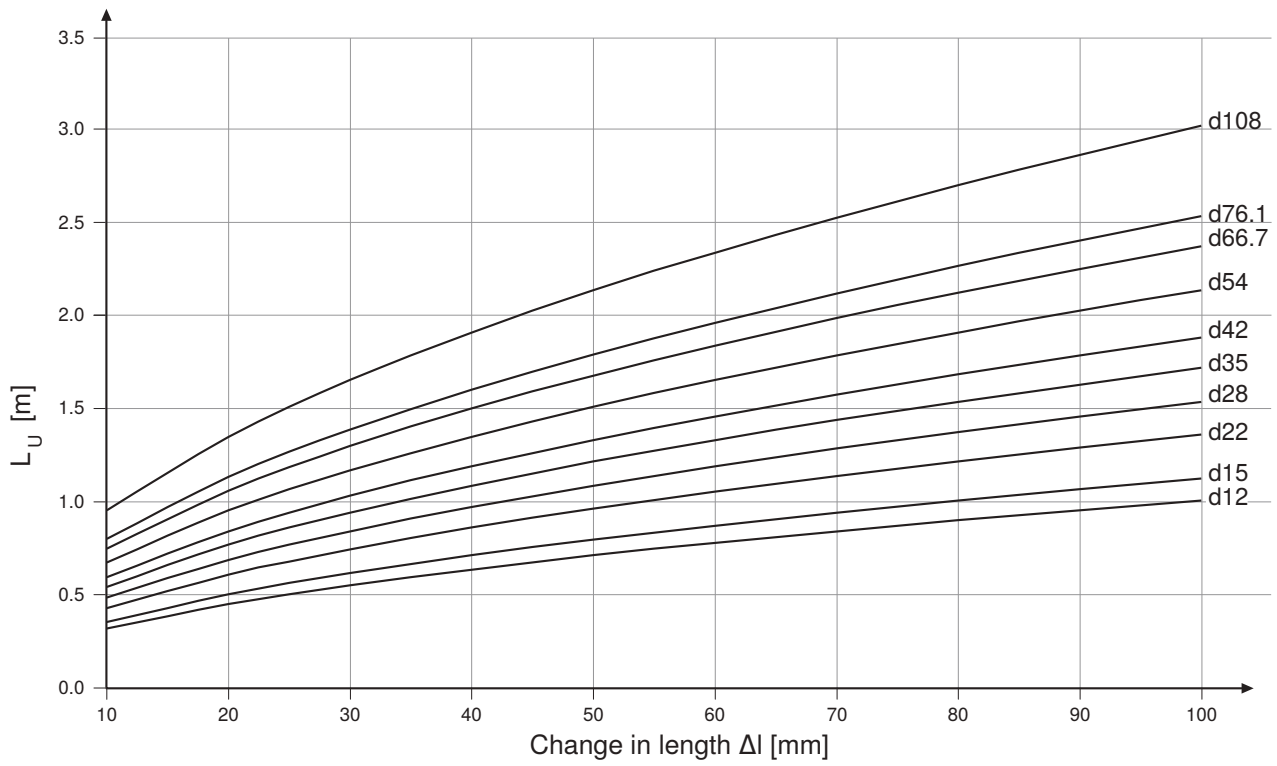

Figure 183: Deflection leg length L_U , copper pipes according to EN 1057

Calculation of the deflection leg length for Mapress CuNiFe

The thermal expansion of pipes depends on the material, among other things. Material-dependent parameters must be considered when calculating the deflection leg length. The following table lists the parameters for Geberit Mapress CuNiFe.

Table 75: Material-dependent Geberit Mapress CuNiFe parameters for calculating the deflection leg length

System pipe	Material	Thermal expansion coefficient α [mm/(m·K)]	Material constant	
			C	U
Geberit Mapress CuNiFe 2.1972.11	Copper-nickel forging alloy	0.017	54	31

C for calculating the deflection leg length L_B (change in direction, branch pipe)

U for calculating the deflection leg length L_U (U-bend)

The calculation of the deflection leg length comprises the following steps:

- Calculation of the change in length Δl
- Calculation of the deflection leg length L_B with a change in direction and branch pipe or calculation of the deflection leg length L_U with U-bends.

Calculation of the change in length Δl

The change in length Δl is calculated using the following formula:

$$\Delta l = L \cdot \alpha \cdot \Delta T$$

Δl Change in length [mm]

L Pipe length [m]

ΔT Temperature differential (operating temperature - ambient temperature at time of installation) [K]

α Thermal expansion coefficient α [mm/(m · K)]

Given:

- material: CuNiFe, material number 2.1972.11
- L=30 m
- $\alpha = 0.017$ mm/(m·K)
- $\Delta T = 50$ K

Required:

- Change in length Δl [mm]

Solution:

$$\Delta l = L \cdot \alpha \cdot \Delta T \left[\frac{\text{m} \cdot \text{mm} \cdot \text{K}}{\text{m} \cdot \text{K}} = \text{mm} \right]$$

$$\Delta l = 30 \cdot 0.017 \cdot 50 \text{ K}$$

$$\Delta l = 25.5 \text{ mm}$$

The change in length Δl can also be calculated in a simplified manner from the following tables.

Table 76: Change in length Δl in mm for Geberit Mapress CuNiFe system pipe

L [m]	Temperature differential ΔT [K]									
	10	20	30	40	50	60	70	80	90	100
1	0.17	0.34	0.51	0.68	0.85	1.02	1.19	1.36	1.53	1.70
2	0.34	0.68	1.02	1.36	1.70	2.04	2.38	2.72	3.06	3.40
3	0.51	1.02	1.53	2.04	2.55	3.06	3.57	4.08	4.59	5.10
4	0.68	1.36	2.04	2.72	3.40	4.08	4.76	5.44	6.12	6.80
5	0.85	1.70	2.55	3.40	4.25	5.10	5.95	6.80	7.65	8.50
6	1.02	2.04	3.06	4.08	5.10	6.12	7.14	8.16	9.18	10.20
7	1.19	2.38	3.57	4.76	5.95	7.14	8.33	9.52	10.71	11.90
8	1.36	2.72	4.08	5.44	6.80	8.16	9.52	10.88	12.24	13.60
9	1.53	3.06	4.59	6.12	7.65	9.18	10.71	12.24	13.77	15.30
10	1.70	3.40	5.10	6.80	8.50	10.20	11.90	13.60	15.30	17.00
20	3.40	6.80	10.20	13.60	17.00	20.40	23.80	27.20	30.60	34.00
30	5.10	10.20	15.30	20.40	25.50	30.60	35.70	40.80	45.90	51.00
40	6.80	13.60	20.40	27.20	34.00	40.80	47.60	54.40	61.20	68.00
50	8.50	17.00	25.50	34.00	42.50	51.00	59.50	68.00	76.50	85

L Pipe length

Calculation of the deflection leg length with a change in direction and branch pipe

The deflection leg length L_B to be calculated is defined as follows with change in direction and for branch pipes:

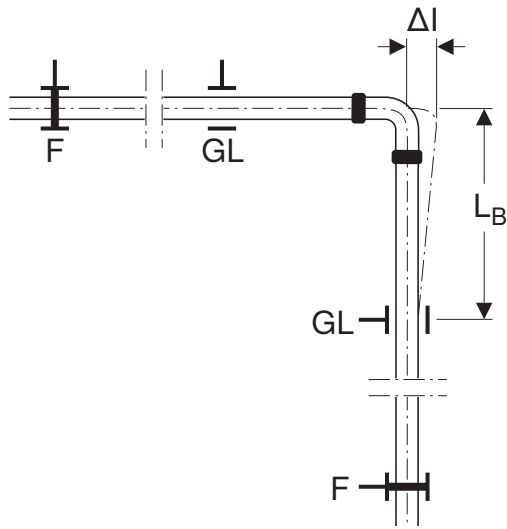

Figure 184: Expansion compensation with a change in direction

- F Anchor point
- GL Sliding point
- L_B Deflection leg length
- Δl Change in length

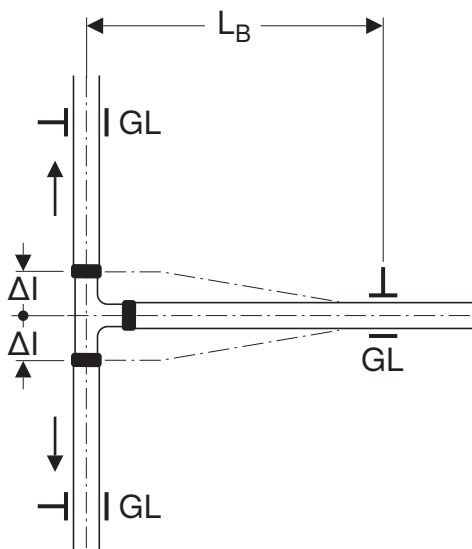

Figure 185: Expansion compensation with branch pipe

- GL Sliding point
- L_B Deflection leg length
- Δl Change in length

The deflection leg length L_B is calculated using the following formula:

$$L_B = \frac{C \cdot \sqrt{d \cdot \Delta l}}{1000}$$

- L_B Deflection leg length [m]
- d Outer pipe diameter [mm]
- Δl Change in length [mm]
- C Material constant

Given:

- material: CuNiFe, material number 2.1972.11
- C = 54
- d = 54 mm
- Δl = 21 mm

Required:

- L_B [m]

Solution:

$$L_B = \frac{C \cdot \sqrt{d \cdot \Delta l}}{1000} \left[\frac{\sqrt{\text{mm} \cdot \text{mm}}}{\frac{\text{mm}}{\text{m}}} = \text{m} \right]$$

$$L_B = \frac{54 \cdot \sqrt{54 \cdot 21}}{1000} \text{ m}$$

$$L_B = 1.82 \text{ m}$$

The deflection leg length L_B can also be calculated in a simplified manner from the following graphics:

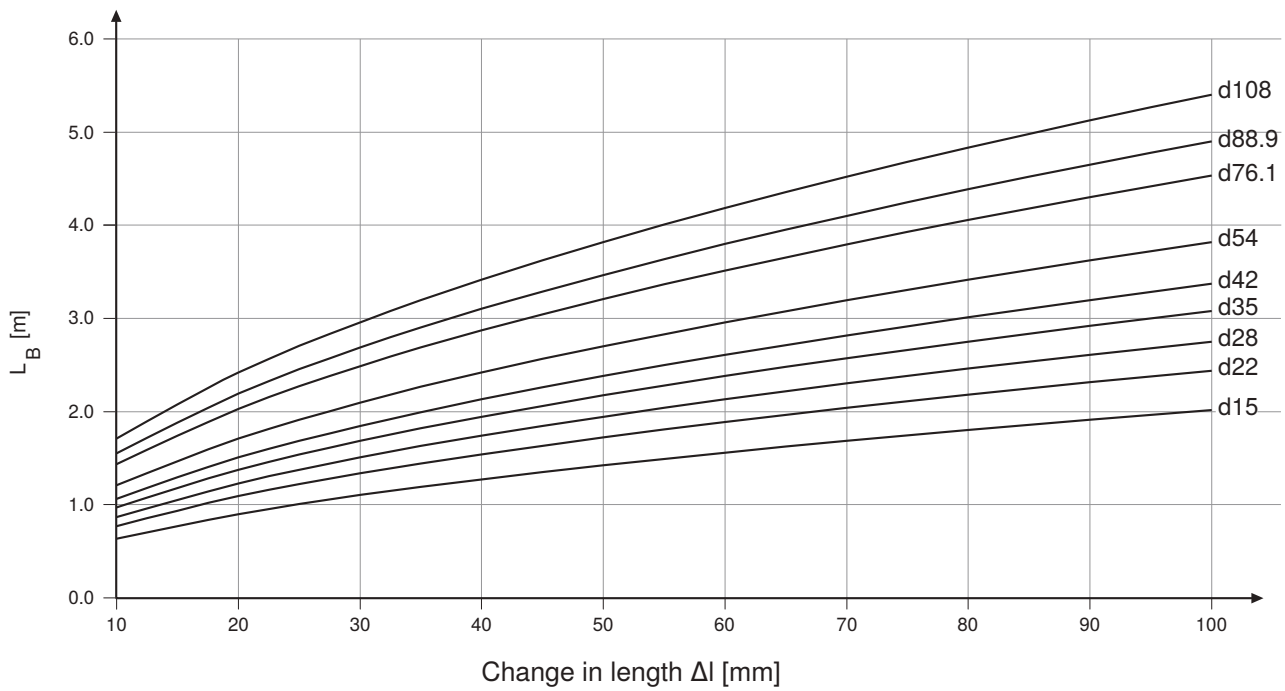

Figure 186: Deflection leg length L_B, Geberit Mapress CuNiFe

Calculation of the deflection leg length for U-bends

The deflection leg length L_U to be calculated is defined as follows:

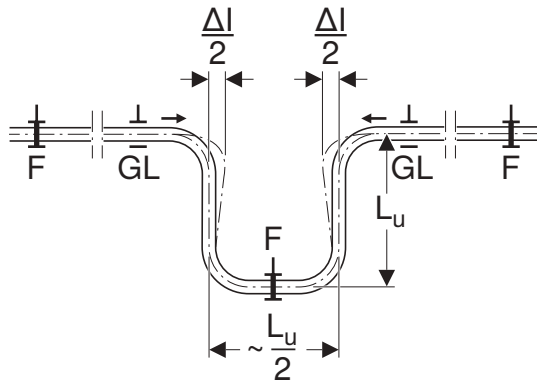

Figure 187: U-bend, made of bent pipe

- F Anchor point
- GL Sliding point
- L_U Deflection leg length
- Δl Change in length

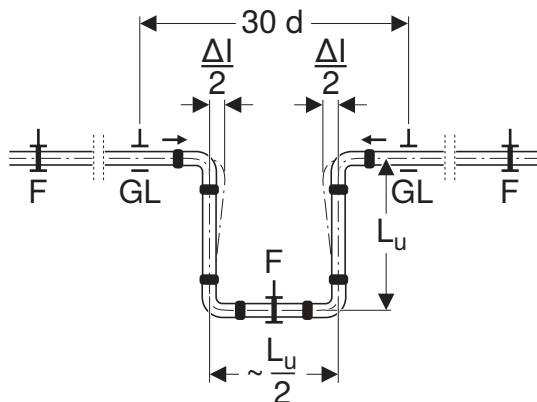

Figure 188: U-bend, made with pressfittings

- F Anchor point
- GL Sliding point
- L_U Deflection leg length
- Δl Change in length

The deflection leg length L_U is calculated using the following formula:

$$L_U = \frac{U \cdot \sqrt{d \cdot \Delta l}}{1000}$$

- L_U Deflection leg length [m]
- d Outer pipe diameter [mm]
- Δl Change in length [mm]
- U Material constant

Given:

- material: CuNiFe, material number 2.1972.11
- $U=31$
- $d = 54 \text{ mm}$
- $\Delta l = 21 \text{ mm}$

Required:

- $L_U \text{ [m]}$

Solution:

$$L_U = \frac{U \cdot \sqrt{d \cdot \Delta l}}{1000} \left[\frac{\sqrt{\text{mm} \cdot \text{mm}}}{\frac{\text{mm}}{\text{m}}} = \text{m} \right]$$

$$L_U = \frac{31 \cdot \sqrt{54 \cdot 21}}{1000} \text{ m}$$

$$L_U = 1.04 \text{ m}$$

The deflection leg length L_U can also be calculated in a simplified manner from the following graphics:

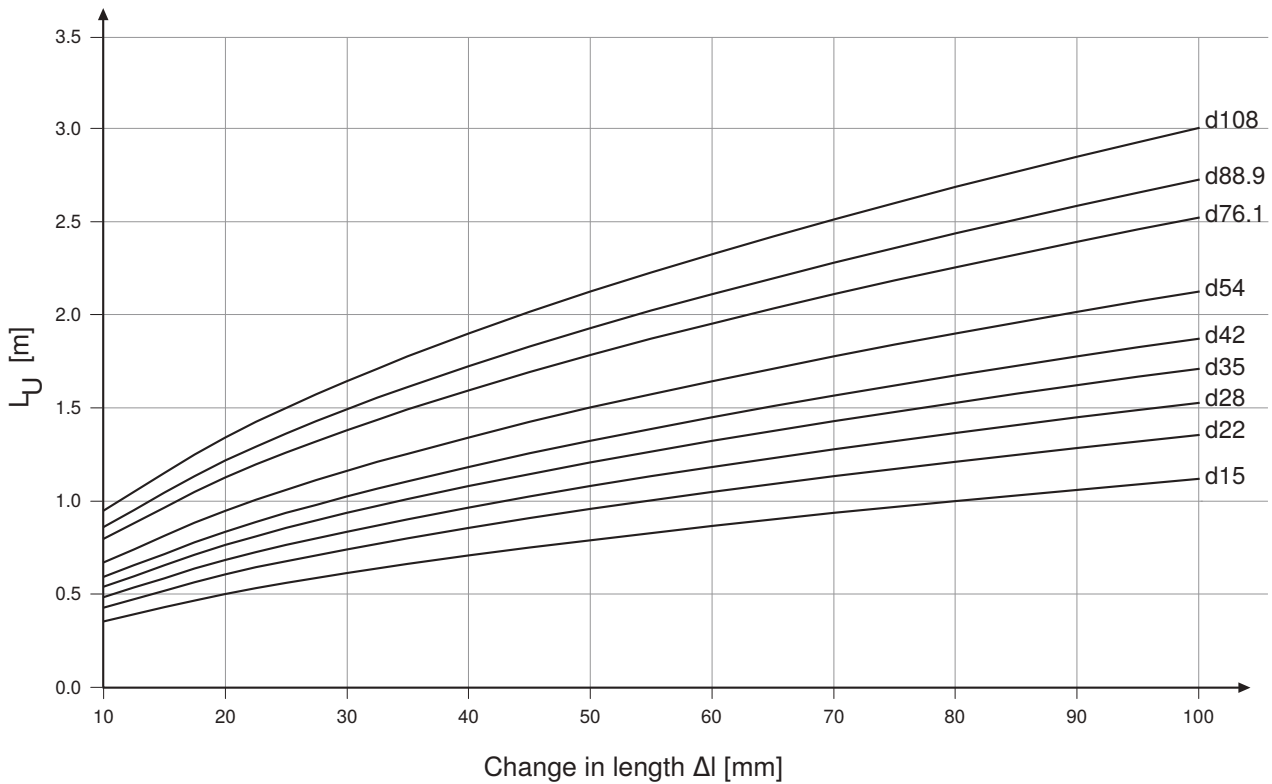

Figure 189: Deflection leg length L_U , Geberit Mapress CuNiFe

2.6.3 Axial expansion fitting as an expansion compensator

The change in length can also be absorbed by Geberit Mapress axial expansion fittings with pressing sockets.

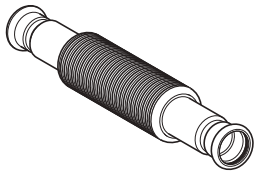

Figure 190: Geberit Mapress axial expansion fitting, d15–54 mm

operating conditions

Geberit Mapress axial expansion fittings are designed for the following operating conditions:

- maximum operating temperature: 120 °C
- maximum operating pressure: 16 bar

Technical data

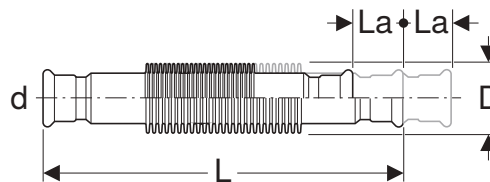
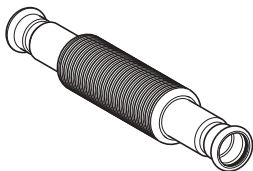

Table 77: Technical data for Geberit Mapress axial expansion fittings with pressing sockets

Art. no. Geberit Mapress Carbon Steel axial expansion fitting	Art. no. Geberit Mapress Stainless Steel axial expansion fitting	d [mm]	D [cm]	L [cm]	L _a [cm]	A _B [cm ²] ¹⁾	c _{ax} [N/mm] ²⁾
23932	33932	15	2.6	15.1	±0.7	3.4	48
23933	33933	18	2.6	14.7	±0.7	3.4	48
23934	33934	22	3.1	10.6	±1.1	5.0	39
23935	33935	28	3.9	12.0	±1.3	8.1	24
23936	33936	35	4.6	13.9	±1.3	11.8	60
23937	33937	42	5.9	14.9	±1.3	19.3	110
23938	33938	54	7.0	17.6	±1.8	28.1	85
23939	33939	76.1	8.8	26.2	±2.2	45.6	88
23940	33940	88.9	11.7	28.6	±2.3	84.5	155
23941	33941	108	14.4	54.2	±2.3	130.3	156

¹⁾ Bellows' cross-sectional area, internal

²⁾ Axial spring rate

Product materials:

- Geberit Mapress Carbon Steel axial expansion fitting: non-alloy steel 1.0034
- Geberit Mapress Stainless Steel axial expansion fitting: CrNiMo steel 1.4401

Calculation of the number of axial expansion fittings

The maximum expansion absorption L_A must not be exceeded. If the expansion absorption of an axial expansion fitting is not sufficient to accommodate the change in length, several axial expansion fittings must be installed.

The calculation of the required number of axial expansion fittings comprises the following steps:

- calculation of the change in length Δl
- calculation of the number of axial expansion fittings N

Calculation of the change in length

The following factors affect the change in length of a pipe:

- temperature differential ΔT between installation and operation of the piping system
- thermal expansion coefficient of the piping system
- Pipe length

Table 78: Thermal expansion coefficients for Geberit Mapress piping systems

Geberit Mapress piping system	Thermal expansion coefficient α [mm / (m · K)]
Stainless steel 1.4401	0.0165
Stainless steel 1.4301	0.0160
Stainless steel 1.4521	0.0104
Carbon steel	0.0120
Copper	0.0166

The change in length is calculated using the following formula:

$$\Delta l = L \cdot \alpha \cdot \Delta T$$

Δl Change in length [mm]

L Pipe length [m]

ΔT Temperature differential (operating temperature – installation temperature) [K]

α Thermal expansion coefficient α [mm/(m · K)]

Example for calculating the change in length

Given:

- material: Stainless steel 1.4401
- $\alpha = 0.0165$ mm/(m·K)
- $L = 15$ m
- $\Delta T = 50$ K

Required:

- change in length Δl of the pipe [mm]

Solution:

$$\Delta l = L \cdot \alpha \cdot \Delta T \left[\frac{\text{m} \cdot \text{mm} \cdot \text{K}}{\text{m} \cdot \text{K}} = \text{mm} \right]$$

$$\Delta l = 15 \text{ m} \cdot 0.0165 \frac{\text{mm}}{\text{m} \cdot \text{K}} \cdot 50 \text{ K}$$

$$\Delta l = 12.4 \text{ mm}$$

Calculation of the number of axial expansion fittings

The number of axial expansion fittings N is calculated using the following formula:

$$N = \frac{\Delta l}{L_a}$$

- N Number of axial expansion fittings
- Δl Change in length [mm]
- L_a Length compensation of the axial expansion fitting [mm]

Example

Given:

- Geberit Mapress axial expansion fitting with d54
- L_a with d54 = 18 mm
- Δl = 12.4 mm

Required:

- N

Solution:

$$N = \frac{\Delta l \left[\frac{\text{mm}}{\text{mm}} \right]}{L_a \left[\frac{\text{mm}}{\text{mm}} \right]}$$

$$N = \frac{12.4}{18} = 0.69$$

N = 1 axial expansion fitting

1 axial expansion fitting is required to accommodate the change in length.

Installation notes

The following information must be observed when installing Geberit Mapress axial expansion fittings:

- Do not load axial expansion fitting by turning it (torsion).
- Do not load the axial expansion fitting by bending or offsetting it.
- Protect the axial expansion fitting against damage and dirt.
- Geberit Mapress axial expansion fittings are maintenance-free, but must still be easily accessible. When installing in ducts, service openings must be provided.

Maximum length compensation

By pre-tensioning the Geberit Mapress axial expansion fittings with open bellows, it is possible to use the maximum length compensation. For this, the axial expansion fitting is pulled or pressed to the required length. It is important to ensure that the axial expansion fitting is not over-expanded or too compressed. Geberit Mapress axial expansion fittings are not pre-tensioned on delivery.



In drinking water installations, Geberit Mapress axial expansion fittings must be mounted without pre-tensioning.

Configuration of anchor points and sliding points

When creating anchor and sliding points, the following rules must be observed:

- Do not use swing suspensions between the anchor points.
- Mount the anchor and sliding points securely before the pressure test.
- Configure the sliding points as guide bearings.
- Mount just one Geberit Mapress axial expansion fitting between two anchor points.

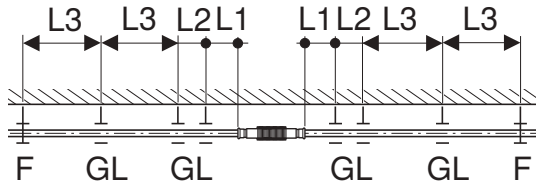

Figure 191: Correct position of the anchor points and sliding points

GL Sliding point

F Anchor point

L1 Fastening distance to the pressing socket of the axial expansion fitting

L2 Maximum fastening distance to the first sliding points after the axial expansion fitting

L3 Maximum fastening distance between sliding points and anchor points

Table 79: Fastening distances of anchor points and sliding points for Geberit Mapress axial expansion fittings

d [mm]	L1 [cm]	L2 _{max.} [cm]	L3 _{max.} [cm]
15	3.0	95	135
18	3.5	105	155
22	5.5	120	175
28	6.0	140	200
35	7.0	155	225
42	9.0	175	250
54	11.0	195	280

Anchor point load

Table 80: Anchor point load at maximum pipe expansion capacity and maximum test pressure

d [mm]	Δ_{ax} [mm]	F_H [kN] at test pressure	
		16 bar ¹⁾	24 bar ²⁾
15	14	1.22	1.5
18	14	1.22	1.5
22	22	1.66	2.1
28	26	1.92	2.6
35	26	3.45	4.4
42	26	5.95	7.5
54	36	7.56	9.8

d Outer pipe diameter

Δ_{ax} Maximum pipe expansion capacity

F_H Anchor point load

1) Maximum operating pressure = 10 bar

2) Maximum operating pressure = 16 bar

Axial expansion fittings in riser pipes

The change in length can be accommodated by axial expansion fittings in riser pipes over several floors.

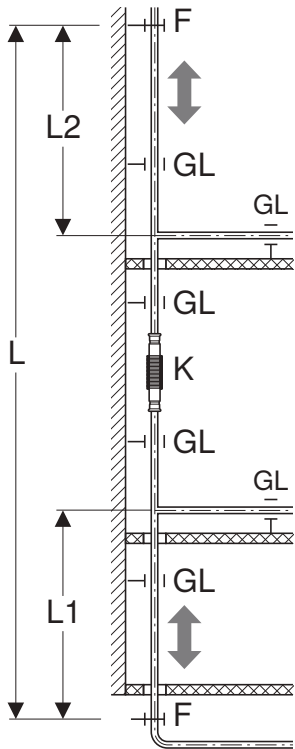

Figure 192: Expansion compensation using axial expansion fittings with an anchor point on the lower floor and on a mezzanine floor.

- BS Deflection leg
- F Anchor point
- GL Sliding point
- L Pipe length
- K Axial expansion fitting

2.7 INSULATION OF PIPE SYSTEMS

The insulation of pipe systems must fulfil various functions depending on the constructional situation:

- anticondensation insulation
- thermal insulation
- sound insulation
- absorption of low thermal expansion in pipes

There are a few basic rules to consider when insulating pipe systems:

- It is essential that the choice of insulation is designed to suit the area of use in order to ensure that insulation materials do not damage the pipe material. The restrictions on use provided by the insulation material manufacturers must be observed.
- Insulation materials must be protected against moisture or consist of closed cells in order to avoid a reduction in the insulating effect. Insulation does not replace corrosion protection.
- The installation and routing guidelines provided by the insulation material manufacturers must be observed.
- Insulation shells are not suitable for the absorption of low thermal expansion.
- The absorption of low thermal expansion in pipes is only possible in soft insulation.
- The insulation must be selected according to the respective area of application.

2.7.1 Insulation of potable water pipes

In drinking water pipes, the insulation fulfils the function of maintaining the drinking water quality, amongst other things. Cold-water pipes must be insulated against heat and hot water pipes against heat loss.

Missing or unsuitable insulation has the following consequences:

- In cold-water pipes, the water quality can be affected by heat, e.g. through the formation of legionella. The temperature changes also lead to condensation, which encourages corrosion.
- In hot water pipes and circulation lines, the water quality can be affected by heat loss, e.g. through the formation of legionella. Heat loss also leads to increased energy consumption.



The design of the insulation and the insulation thicknesses depend on country-specific specifications and regulations.

2.7.2 Insulation thicknesses for cold-water pipes according to DIN 1988-200

The minimum insulation thicknesses for cold-water pipes can be taken from the following table for an insulation material with the thermal conductivity $\lambda = 0.040 \text{ W/(m}\cdot\text{K)}$. The values are designed for residential construction and apply for ambient temperatures of 5–25 °C and a maximum of 85% humidity.

Table 81: Minimum insulation thicknesses for cold-water pipes (according to DIN 1988-200:2012-05)

Installation situation	Ambient temperature	Insulation thickness for the thermal conductivity $\lambda = 0.040 \text{ W/(m}\cdot\text{K)}$
Surface-mounted pipes in unheated rooms (e.g. basement)	$\leq 20 \text{ °C}$ (only protection against condensed water)	9 mm
Pipes laid in pipe ducts, floor ducts and suspended ceilings	$\leq 25 \text{ °C}$	13 mm
Pipes laid, for example, in plant rooms or media channels and ducts with heat loads	$\geq 25 \text{ °C}$	Insulation such as for hot water pipes, installation situation 1–5
Floor pipes and individual supply pipes in prewall installations	—	4 mm or pipe-in-pipe
Floor pipes and individual supply pipes in floor constructions (also in addition to non-circulating hot water pipes) ¹⁾	—	4 mm or pipe-in-pipe
Floor pipes and individual supply pipes in a floor construction in addition to heated circulating pipes ¹⁾	—	13 mm

λ Thermal conductivity of the insulation material at 10 °C

— Does not apply

- 1) The laying of cold-water pipes in connection with underfloor heating must fulfil the requirements of section 3.6 “Operating temperature” of DIN 1988-200:2012-05. This means that 30 seconds after fully opening a point of use, the temperature of the cold drinking water must not exceed 25 °C during normal operation.

2.7.3 Insulation thicknesses for hot water pipes according to the Building Energy Act

The insulation thicknesses for heat distribution and hot water pipes and valves can be found in the following table. The specified insulation thicknesses refer to the inner diameter of the pipes. In the case of insulation materials with other thermal conductivity values, the insulation thicknesses must be converted.

Table 82: Minimum insulating layer thicknesses for hot water pipes according to the German Building Energy Act (GEG)

Installation situation	Insulation thickness for the thermal conductivity $\lambda = 0.035 \text{ W/(m}\cdot\text{K)}$
1 Inner diameter $\leq 22 \text{ mm}$	20 mm
2 Inner diameter $> 22 \text{ and } \leq 35 \text{ mm}$	30 mm
3 Inner diameter $> 35 \text{ and } \leq 100 \text{ mm}$	Same as the inner diameter
4 Inner diameter $> 100 \text{ mm}$	100 mm
5 Pipes and valves according to installation situations 1–4 in wall and ceiling openings, at pipe junctions, at pipe connection points and in central distribution systems	Half of the respective value for the installation situations 1–4
6 Hot drinking water pipes that are neither included in the circulation circuit nor equipped with pipe heating cable are, for example, floor pipes and individual supply pipes with a water content $\leq 3 \text{ l}$	No insulation requirements against heat emission ¹⁾

λ Thermal conductivity of the insulation material at 40 °C

- 1) Insulation is required for a concealed installation (e.g. pipe-in-pipe or 4 mm as mechanical protection or – for heating and cooling water installations with pipes made of non-alloy steel – as corrosion protection).

2.7.4 Sound insulation

Geberit supply systems do not produce any inherent noises with the correct system planning and installation. However, they emit noises that come from appliances and valves. Pipes must therefore be equipped with structure-borne sound insulation that consistently decouples the piping system from the building structure, for example, with feed-throughs or through the use of insulated pipe brackets. The insulation must be implemented correctly and without any gaps. The thickness of the insulation is not of importance. Any country-specific requirements must be observed.

Sound insulation for tap connectors

In order to prevent the transmission of structure-borne sound, when fastening tap connectors they must be decoupled from the building structure with a sound insulation set. In addition, it is necessary to prevent the connections getting dirty when fastening them, e.g. from mortar.

Geberit connection bends can be protected with the following accessories:

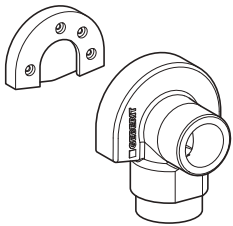

Figure 193: Geberit sound insulation set for single elbow tap connector 90°

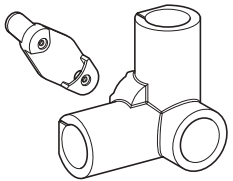

Figure 194: Sound insulation set for Geberit Mapress single corner elbow connector 90°

Sound-insulating pipe jacketing

Pipe insulation devices such as insulation tape, insulation hoses, insulation shells with jacketing or terminations serve as sound-insulating measures which decouple the piping system from the building structure.

The thickness of the insulation does not matter when it comes to decoupling from the building structure. Insulation must not be able to absorb cement slurry, as this will re-establish contact between the pipe and the building.

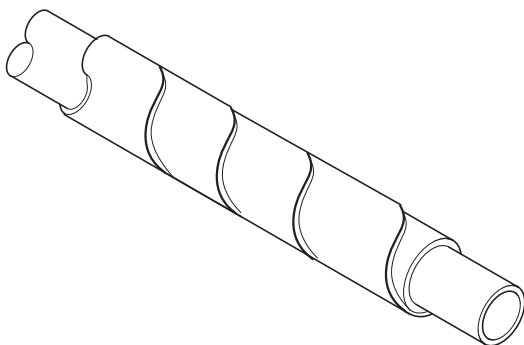

Figure 195: Geberit insulation tape

2.8 CORROSION

Corrosion is the reaction of a metallic material to its environment, which causes a measurable change in the material and can lead to an impairment in the function of a component or an entire system. Different types of corrosion can occur depending on the material and application area. A distinction is generally made between external corrosion and internal corrosion. However, certain types of corrosion can occur both internally and externally. Corresponding corrosion protection measures must be taken into account to avoid corrosion occurring.

2.8.1 Corrosion behaviour of Geberit Mapress Stainless Steel

Resistance of stainless steel 1.4401 and 1.4521 to internal corrosion

Corrosion-resistant steels have a protective layer of chromium oxide. Due to this protective layer, the Geberit Mapress Stainless Steel 1.4401 and 1.4521 piping systems are corrosion-resistant to the following media:

- drinking water
- treated water (suitable for all water treatment techniques, such as ion exchange or reverse osmosis)
 - softened (decarbonised) water
 - fully desalinated water (deionised, demineralised, distilled and pure condensates)
 - ultrapure water with a conductivity of $\geq 0.1 \mu\text{S/cm}$
- cooling water

Local corrosion symptoms (e.g. pitting or crevice corrosion) can only occur in combination with inadmissibly high chloride content levels in media. Inadmissibly high chloride content levels occur, for example, if too much disinfectant containing chlorine is used when disinfecting drinking water pipes. For this reason, the application duration and concentration of the disinfectant must be strictly observed.

In order to avoid internal corrosion, the content of water-soluble chloride ions in drinking water, treated water and cooling water must not exceed 250 mg/l.

Resistance of stainless steel 1.4301 to internal corrosion

Corrosion-resistant steels have a protective layer of chromium oxide. Due to this protective layer, the Geberit Mapress Stainless Steel 1.4301 piping system is corrosion-resistant to the following media:

- treated water (suitable for all water treatment techniques, such as ion exchange or reverse osmosis)
 - softened (decarbonised) water
 - fully desalinated water (deionised, demineralised, distilled and pure condensates)
 - ultrapure water with a conductivity of $\geq 0.1 \mu\text{S/cm}$
- cooling water

Local corrosion symptoms (e.g. pitting or crevice corrosion) can only occur in combination with inadmissibly high chloride content levels in media.

In order to avoid internal corrosion, the content of water-soluble chloride ions in drinking water, treated water and cooling water must not exceed 250 mg/l.

Resistance to external corrosion

Geberit Mapress Stainless Steel is resistant to environmental conditions in the corrosivity categories C1, C2 and C3 as well as Im1 and Im3 without additional corrosion protection (see table below). In the case of ambient conditions that are assigned to a different corrosivity category, corrosion protection measures are required, which must be defined in individual cases.

The following factors increase the risk of external corrosion:

- contact with building materials that promote corrosion (e.g. building materials containing chloride)
- installation in aggressive atmospheres (e.g. chlorine, nitric acid, hydrochloric acid)
- installations in which direct or indirect contact with electrical current (leakage current, amongst others) in combination with moisture cannot be excluded

In cases such as these, suitable measures should be implemented to protect Geberit Mapress Stainless Steel.

Table 83: Categories of atmospheric ambient conditions according to DIN EN ISO 12944-2

Corrosivity category		Examples
C1	Unimportant	Inside only: heated buildings with neutral atmospheres
C2	Low	Rural areas, unheated buildings where condensation can occur, e.g. warehouses, sports halls
C3	Moderate	Urban and industrial atmospheres with moderate air pollution, coastal areas with low salt pollution, production rooms with high humidity and some air pollution (e.g. food production, laundries, breweries)
C4	Heavy	Industrial areas, coastal areas with moderate salt pollution, chemical plants, swimming pools
C5-I	Very heavy (industry)	Industrial areas with high humidity and aggressive atmospheres
C5-M	Very heavy (sea)	Coastal and offshore areas with high salt pollution, buildings with almost constant condensation and with heavy air pollution
Im1	Fresh water	Riverside buildings, hydroelectric power plants
Im2	Seawater or brackish water	Port areas with steel structures, lock gates, jetties, offshore installations
Im3	Ground	Receptacles in the ground, steel sheet piles, steel pipes

Protection against external corrosion

Pipes must be treated with suitable corrosion protection to avoid external corrosion. Sealing tape or closed-cell insulation have been proven to protect against external corrosion, as they prevent an accumulation of chlorides.

Corrosion protection must have the following properties:

- waterproof
- non-porous
- resistant to heat and ageing
- undamaged

The following rules must be observed when planning and designing the corrosion protection:

- A pressure test of the piping system must be carried out before applying the corrosion protection.
- The minimum protection against external corrosion is coating, priming or painting.
- Hoses or felt wrapping is not admissible, as felt retains absorbed moisture for prolonged periods and therefore promotes corrosion.
- The corrosion protection must not be damaged by pressing tools or other external influences.



Sanitary engineers and fitters are responsible for planning and implementing the corrosion protection.

Geberit sealing tape

Geberit sealing tape is characterised by the following advantages:

- reliable protection against external corrosion tested by Geberit
- self-adhesive
- easy installation

The processing temperature is between -10 °C and +50 °C. Geberit sealing tape is designed for operating temperatures of -60 to +100 °C and therefore suitable for heating and cooling water installations. Geberit sealing tape is available in widths of 30 mm and 50 mm.

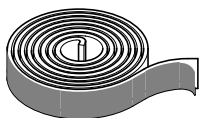

Figure 196: Geberit sealing tape

The following must be observed during installation:

- material overlap (pipe) at least 5 cm
- material overlap (wrapping) at least 1 cm
- sealing tape with a width of 3 cm for an outer diameter up to d24 mm
- sealing tape with a width of 5 cm from an outer diameter of d25 mm
- winding always under tension

Attaching the sealing tape

✓ Leak test has been carried out.

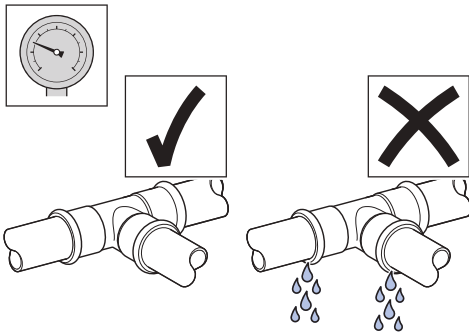

1 Clean the surfaces of the connection points liberally.

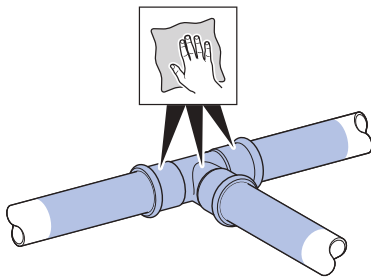

2 Wrap sealing tape around the pipe.

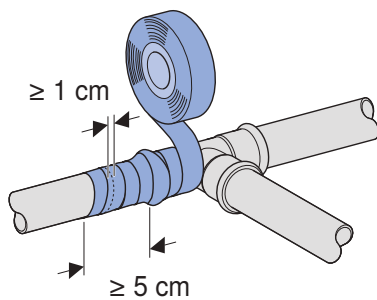

⇨

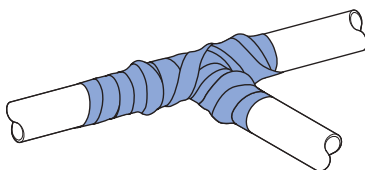

Geberit insulation hose

The Geberit insulation hose made of closed-cell PE soft foam protects Geberit Mapress system pipes and fittings against chemical and electro chemical influences from the outside.

The insulation hose is intended for gas installations and has an outer diameter of d15–54 mm.



Figure 197: Geberit insulation hose with yellow protective foil

Corrosion behaviour of stainless steel in contact with other materials

Geberit Mapress Stainless Steel 1.4401, 1.4521 and 1.4301 can be combined with all materials in any order without affecting the corrosion behaviour. The flow direction of the water must not be observed (no flow rules).

However, with a connection to zinc-plated steel pipes, bimetallic corrosion (galvanic corrosion) occurs on the zinc-plated steel pipes.

To avoid bimetallic corrosion, one or more of the following measures must be taken:

- Installation of distance pieces (length $L > 50$ mm of surface in contact with water)
- Use of Geberit Mapress adapters made of gunmetal
- Installation of a shut-off valve made of a non-ferrous heavy metal



Figure 198: Geberit Mapress Copper adapter with male thread and plain end made of gunmetal

Discolouring caused by deposits of other corrosive products does not indicate any risk of corrosion.

Corrosion risks during installation, processing and operation

When processing, installing and operating Geberit Mapress Stainless Steel systems with stainless steel 1.4401, 1.4521 and 1.4301, certain rules and general conditions must be observed in order to avoid corrosion. The most important scenarios and protective measures are summarised below.

Scenario		Type of corrosion	Protective measure
Installation in a corrosive environment	Contact with building materials that promote corrosion, e.g. building materials containing chlorine or chloride	External corrosion Pitting corrosion	<ul style="list-style-type: none"> Sealing tape Closed-cell insulation¹⁾
	Installation in aggressive atmospheres (e.g. chlorine, nitric acid, hydrochloric acid)		
	Installations in which direct or indirect contact with electrical current (leakage current, amongst others) in combination with moisture cannot be excluded		
Combination of Geberit Mapress Stainless Steel 1.4401, 1.4521 and 1.4301 with zinc-plated steel pipes		Bimetallic corrosion (galvanic corrosion) ²⁾ on the zinc-plated steel pipe	<ul style="list-style-type: none"> Installation of distance pieces, surface in contact with water must be longer than 50 mm Use of Geberit Mapress adapters made of gunmetal Installation of a shut-off valve made of a non-ferrous heavy metal
Heating of stainless steel pipes	Heating of steel pipes for bending	Intercrystalline corrosion	<ul style="list-style-type: none"> No heating of system pipes made of stainless steel Cutting of system pipes made of stainless steel to length exclusively with the pipe cutter, a pipe saw or a pipe cutting machine No welding of system pipes made of stainless steel
	Cutting to length with an abrasive cut-off wheel (angle grinder) or with a flame cutter		
	Welding of stainless steel pipes		
Screwing joints made of stainless steel	Use of sealing tape and sealing materials made of polytetrafluoroethylene containing water-soluble chloride ions	Crevice corrosion	<ul style="list-style-type: none"> For stainless steel screwing joints, only use chloride-free sealant that has been approved for the respective application
Pressure test with water	Pipe is not completely emptied after the pressure test.	Pitting corrosion	<ul style="list-style-type: none"> The pipe must be completely emptied after the pressure test with water.
Disinfection of drinking water pipes	An excessive dose of the disinfectant containing chlorine leads to an inadmissibly high chloride content in drinking water.	Pitting corrosion, Crevice corrosion	<ul style="list-style-type: none"> Strict adherence to the duration of application and the prescribed concentration of the disinfectant
Water quality	An excessively high content of water-soluble chloride ions	Internal corrosion	<ul style="list-style-type: none"> Strict adherence to the maximum chloride content of 250 mg/l in drinking water, treated water and cooling water and a conductivity ≤ 2500 µs/cm

1) The corrosion protection must be waterproof, non-porous, resistant to heat and ageing and free of damage.

2) Discolouring caused by deposits of other corrosive products does not indicate any risk of corrosion.

2.8.2 Corrosion behaviour of Geberit Mapress Carbon Steel

Resistance to internal corrosion

Heating systems and other closed circuits

Geberit Mapress Carbon Steel is corrosion-resistant in closed heating systems and other closed systems. A system is considered closed only if all components connected to the system (e.g. expansion tank, hoses, pumps and cooling and heating panels) form a barrier against diffusion.

The country-specific requirements must be taken into account with regard to the quality of the heating or refrigerant fluid. It is desirable to have a pH value of 8.2 -10.0 in closed heating systems. Only corrosion and antifreeze agents that have been tested and approved by Geberit may be used.

The probability of corrosion increases when oxygen enters the system. If there is insufficient overpressure compared to the atmosphere, oxygen can enter the circuit via the following components:

- open expansion tanks through which medium flows
- glands
- screw connections
- quick exhaust valve

The oxygen that enters the system when it is being filled and topped up with water does not pose a risk of corrosion as the quantities involved are so small. The oxygen is bonded to iron oxide compounds through the reaction with the steel inner surface of the plant system. In addition, the oxygen that is generated from the heated heating water escapes when the heating system is ventilated.



Concentrations of oxygen greater than 0.1 g/m³ indicate an increased probability of corrosion.



Geberit Mapress Carbon Steel is not corrosion-resistant in respect to the condensate drains of oil fired condensing boilers. The condensate in these systems has a pH value of 2.5–3.5 and may also contain sulphuric acid.

Resistance to external corrosion

Geberit Mapress Carbon Steel 1.0034, outside zinc-plated, bare or plastic-jacketed, is resistant to the environmental conditions of corrosivity category C1 without additional corrosion protection.

Geberit Mapress Carbon Steel 1.0215, inside and outside zinc-plated, is resistant to the environmental conditions of corrosivity category C1 without additional corrosion protection.

Geberit Mapress Carbon Steel must never be laid in rooms with high moisture levels.

However, it is possible that unexpected moisture levels may occur in rooms. External corrosion may occur through longer exposure to unintended corrosive media.

Unintended corrosive media includes, for example:

- rain penetration
- moisture in the masonry or screed
- condensation
- leaking water, spray or cleaning water
- extinguishing water

If there is a risk of unintended corrosive media, suitable measures must be taken to protect Geberit Mapress Carbon Steel.

Table 84: Categories of atmospheric ambient conditions according to DIN EN ISO 12944-2

Corrosivity category		Examples
C1	Unimportant	Inside only: heated buildings with neutral atmospheres
C2	Low	Rural areas, unheated buildings where condensation can occur, e.g. warehouses, sports halls
C3	Moderate	Urban and industrial atmosphere with moderate air pollution, coastal areas with low salt pollution, production rooms with high humidity and some air pollution (e.g. food production, laundries, breweries)
C4	Heavy	Industrial areas, coastal areas with moderate salt pollution, chemical plants, swimming pools
C5-I	Very heavy (industry)	Industrial areas with high humidity and an aggressive atmosphere
C5-M	Very heavy (sea)	Coastal and offshore areas with high salt pollution, buildings with almost constant condensation and with heavy air pollution
Im1	Fresh water	Riverside buildings, hydroelectric power plants
Im2	Seawater or brackish water	Port areas with steel structures, lock gates, jetties, offshore installations
Im3	Ground	Receptacles in the ground, steel sheet piles, steel pipes

Protection against external corrosion

Protection against external corrosion must meet the following requirements:

- waterproof
- non-porous
- forms a barrier against diffusion
- resistant to heat and ageing
- undamaged

To prevent external corrosion, the following must be observed:

- Before applying the corrosion protection, a pressure test and a leak test of the piping system must be carried out.
- Closed-cell sealing materials such as sealing tape or insulation hoses have proven to be effective in protecting against external corrosion. Only dry insulation may be used.
- Geberit Mapress Carbon Steel must never be installed in permanently damp rooms or environments. Lay pipes outside rooms with high humidity levels.
- To protect against unforeseen moisture, the use of Geberit Mapress Carbon Steel (plastic-jacketed) with sealing tape is recommended.
- It is important to prevent direct contact between unprotected carbon steel pipes and fire protection boards in feed-throughs passing through fire sections. A corrosion protection coating or anticorrosion tape must be applied to the pipe at section joints.
- In the case of concealed or underfloor installation, Geberit Mapress Carbon Steel system pipes and pressfittings must be protected using a suitable form of corrosion protection. Geberit strongly recommends the use of Geberit Mapress Carbon Steel (plastic-jacketed) in these areas.
- When laying pipes on concrete floors, a sealing foil must be laid between the concrete floor and the steel pipe in addition to the pipe cladding.
- Vertical radiator connections out of the screed must be avoided, as permanent protection from moisture cannot be guaranteed. Geberit recommends a radiator connection from the back out of the wall, for example, with a radiator connection box.
- The processing guidelines of the corrosion protection manufacturers must always be observed.



The insulation used must be dry.



Sanitary engineers and fitters are responsible for planning and implementing the corrosion protection.

Geberit sealing tape

Geberit sealing tape is characterised by the following advantages:

- reliable protection against external corrosion tested by Geberit
- self-adhesive
- easy installation

The processing temperature is between -10 °C and +50 °C. Geberit sealing tape is designed for operating temperatures of -60 to +100 °C and therefore suitable for heating and cooling water installations. Geberit sealing tape is available in widths of 30 mm and 50 mm.

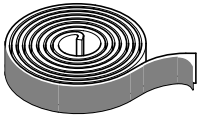

Figure 199: Geberit sealing tape

The following must be observed during installation:

- material overlap (pipe) at least 5 cm
- material overlap (wrapping) at least 1 cm
- sealing tape with a width of 3 cm for an outer diameter up to d24 mm
- sealing tape with a width of 5 cm from an outer diameter of d25 mm
- winding always under tension

Closed-cell insulation hoses

Closed cell insulation hoses have proven to protect against external corrosion, as they prevent the concentration of chlorides. The cut surfaces and joints of the insulation must be carefully bonded, no pores must be created and the insulated pipe must be longitudinally watertight.

Closed-cell insulation is not sufficient corrosion protection for cooling water installations. Coolant water pipes must be protected against corrosion according to AGI worksheet Q 151 "Corrosion protection under insulation".

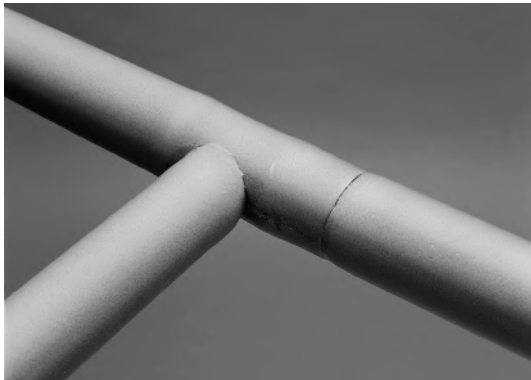

Figure 200: Corrosion protection with closed-cell insulation hoses

Corrosion behaviour of Mapress Carbon Steel in contact with other materials

Geberit Mapress Carbon Steel is resistant to internal corrosion in closed, diffusion-tight water heating systems and water circuits, even in mixed installations.

Geberit Mapress Carbon Steel can be connected in any order with the following materials in such closed diffusion-tight systems without a risk of corrosion.

- Geberit Mapress Stainless Steel
- Geberit Mapress Copper

The dimensions of the Geberit Mapress components are coordinated in such a way that they can be directly pressed together for a change of material. The prerequisite for this is that no moisture or condensation forms on the outside of the pipe.

Corrosion risks during installation, processing and operation

During the processing, installation and operation of Geberit Mapress Carbon Steel systems, certain rules and general conditions must be observed in order to avoid corrosion. The most important scenarios and protective measures are summarised below.

Table 85: Corrosion risks

Scenario		Type of corrosion	Protective measure
Transport in an open means of transport	Pipes are exposed to moisture	External corrosion	<ul style="list-style-type: none"> • Use only closed or well-covered means of transport • Do not cover pipes with plastic foil to prevent condensation
Pipes show signs of corrosion during storage	Pipes are permanently exposed to moisture	External corrosion	<ul style="list-style-type: none"> • Do not cover pipes with plastic foil to prevent condensation • Do not store pipes directly on the floor • Avoid contact with other metals in a humid environment
Unexpected moisture load in rooms	Corrosive media can unintentionally occur, for example, in the following cases: <ul style="list-style-type: none"> • embedded precipitation, especially in new buildings • moisture in the floor construction and masonry • defective water supply line • condensation • leaking and splash water • use of cleaning agents and disinfectants • extinguishing water 	External corrosion	<ul style="list-style-type: none"> • Use of the jacketed pipe with additional sealing tape • Sealing material must be water-resistant and diffusion-tight • The cut surfaces and joints of the insulation hoses must be carefully bonded. • All positions where Mapress Carbon Steel can come into contact with moisture must be wrapped
Use in cooling water installations	Closed-cell insulation alone does not provide corrosion protection	External corrosion	<ul style="list-style-type: none"> • Execute corrosion protection for cooling water installations according to AGI worksheet Q 151 EU
Laying on concrete floors	Moisture from the concrete floor	External corrosion	<ul style="list-style-type: none"> • In addition to the pipe cladding, lay sealing foil between the concrete floor and steel pipe
Radiator connections vertically out of the screed	Contact with cleaning water or aggressive cleaning agents	External corrosion	<ul style="list-style-type: none"> • If possible, install the radiator connection from the back out of the wall, for example, with a radiator connection box
Improper use, for example, for draining condensate from oil fired condensing boilers	Condensate with a pH value of 2.5–3.5 and sulphurous acids	Internal corrosion	<ul style="list-style-type: none"> • Consult the usage overviews or a specialist adviser prior to the installation
Signs of corrosion despite use in a closed system	The system has components that allow oxygen diffusion, for example, glands, screw connections, quick exhaust valves or expansion tanks with a permeable membrane	Internal corrosion	<ul style="list-style-type: none"> • Connect only diffusion-tight components • Connect components that can be ventilated • Produce sufficient overpressure relative to the atmosphere

Scenario		Type of corrosion	Protective measure
Pressure test	No complete emptying of the pipe after the pressure test	Internal corrosion	<ul style="list-style-type: none"> • Empty the pipe completely after the pressure test • Perform the pressure test with compressed air
Water quality	Increased corrosion probability due to <ul style="list-style-type: none"> • Concentrations of oxygen greater than 0.1 g/m³ • pH value is too low (lower than 8.2 in circulating water, lower than 6.0 in filling water) 	Internal corrosion	<ul style="list-style-type: none"> • Observe the country-specific guidelines for heating water. • See the “Geberit piping systems for treated water” technical information for the admissible oxygen concentration, pH values, TOC, etc. • Use only water additives tested and approved by Geberit

2 / 2

2.8.3 Geberit Mapress Carbon Steel system pipes in solar thermal systems

Geberit Mapress Carbon Steel system pipes, outside zinc-plated, are an economical alternative to Geberit Mapress Stainless Steel system pipes and Geberit Mapress Copper system pipes, especially in the case of large pipe dimensions. However, when using Geberit Mapress Carbon Steel system pipes, outside zinc-plated, the following rules must be observed. See the “Geberit piping systems for solar thermal systems” technical information for further information.

Solar thermal drainback system

Solar thermal systems are generally designed as closed circuits. Exceptions are solar systems with a solar thermal drainback system. These solar systems are operated without antifreeze agents in the thermal medium, since they automatically empty when there is a danger of frost. This procedure introduces oxygen into the solar system. Oxygen can cause internal corrosion on Geberit Mapress Carbon Steel system pipes, outside zinc-plated.

Geberit Mapress Carbon Steel system pipes, outside zinc-plated, must therefore not be used for solar thermal systems with a solar thermal drainback system.

Laying pipes in outdoor areas

Laying pipes outdoors is subject to increased requirements for the resistance of the piping system to external corrosion.

The zinc layer of the Geberit Mapress Carbon Steel system pipes, outside zinc-plated, even when combined with correctly implemented thermal insulation, does not provide sufficient corrosion protection for laying pipes outdoors.

Geberit Mapress Carbon Steel system pipes, outside zinc-plated, therefore have to be protected with an additional corrosion protection coating. Alternatively, Geberit Mapress Stainless Steel system pipes can be laid in the outdoor area of the solar system and Geberit Mapress Carbon Steel system pipes, outside zinc-plated, can be laid inside.

Connection of the solar collector to the piping system

Temperatures up to 220 °C can occur for short periods in the connection area of the solar collector. As a result of these high temperatures, the first one to two metres of the piping system must be implemented with a corrugated pipe made of stainless steel and the solar collector must be connected to the corrugated pipe made of stainless steel with a metallic clamping joint.

2.8.4 Corrosion behaviour of Geberit Mapress Copper

Resistance to internal corrosion

Geberit Mapress Copper is corrosion-resistant to the following media:

- Drinking water with the following features:
 - pH value > 7.4
 - 7.4 > pH value > 7.0 and TOC¹⁾ < 1.5 g/m
 - Salt content which does not exceed the limited values of the Drinking Water Ordinance
- Heating water and cooling water in open and closed systems
- Treated water according to the Technical Information “Geberit piping systems for treated water” (suitable for all water treatment processes, such as ion exchange or reverse osmosis)
 - Softened (decarbonised) water
 - Fully desalinated water (deionised, demineralised, distilled and pure condensates)
 - Ultrapure water with a conductivity of $\geq 0.1 \mu\text{S/cm}$

¹⁾ TOC (Total Organic Carbon): total organic carbon content

Resistance to external corrosion

Geberit Mapress Copper is resistant to the ambient conditions of corrosivity categories C1, C2 and C3 without additional corrosion protection (see table below). In the case of ambient conditions that are assigned to a different corrosivity category, corrosion protection measures are required, which must be defined in individual cases.

The following factors increase the risk of external corrosion:

- Contact with building materials that promote corrosion (e.g. building materials containing sulphides, nitrites and ammonium)
- Installation in aggressive atmospheres (e.g. chlorine, nitric acid, hydrochloric acid)

In cases such as these, suitable measures should be implemented to protect Geberit Mapress Copper.

Table 86: Categories of atmospheric ambient conditions according to DIN EN ISO 12944-2

Corrosivity category		Examples
C1	Unimportant	Inside only: heated buildings with neutral atmospheres
C2	Low	Rural areas, unheated buildings where condensation can occur, e.g. warehouses, sports halls
C3	Moderate	Urban and industrial atmosphere with moderate air pollution, coastal areas with low salt pollution, production rooms with high humidity and some air pollution (e.g. food production, laundries, breweries)
C4	Heavy	Industrial areas, coastal areas with moderate salt pollution, chemical plants, swimming pools
C5-I	Very heavy (industry)	Industrial areas with high humidity and an aggressive atmosphere
C5-M	Very heavy (sea)	Coastal and offshore areas with high salt pollution, buildings with almost constant condensation and with heavy air pollution
Im1	Fresh water	Riverside buildings, hydroelectric power plants
Im2	Seawater or brackish water	Port areas with steel structures, lock gates, jetties, offshore installations
Im3	Ground	Receptacles in the ground, steel sheet piles, steel pipes

Corrosion behaviour of Mapress Copper in contact with other materials

Geberit Mapress Copper can be combined with all the materials in the following systems without affecting the corrosion behaviour:

- atmospherically closed water heating systems
- water circuits without risk of internal corrosion

However, when combined with zinc-plated steel pipes, bimetallic corrosion (galvanic corrosion) can occur on the zinc-plated steel pipes if the flow rule is not observed. To avoid bimetallic corrosion, copper must always be installed in the direction of water flow downstream of components made of zinc-plated steel.

Stress corrosion cracking in copper-zinc alloys (brass)

Stresses can occur in components in water distribution systems according to EN 12502-1:2004 (DIN EN 12502-1:2005-03), which can cause stress corrosion cracking in combination with corrosive media.

When working with brass threaded joints, it is important to make sure not to apply too much stress, such as by overtightening them.

Corrosion risks during installation, processing and operation

During the processing, installation and operation of Geberit Mapress Copper systems, certain rules and general conditions must be observed in order to avoid corrosion. The most important scenarios and protective measures are summarised below.

Scenario		Type of corrosion	Protective measure
Installation in a corrosive environment	Contact with building materials that promote corrosion, e.g. building materials containing sulphides, nitrites and ammonium	External corrosion Pitting corrosion	<ul style="list-style-type: none"> Sealing tape Closed-cell insulation¹⁾
	Installation in aggressive atmospheres (e.g. chlorine, nitric acid, hydrochloric acid)		
Combination of Mapress Copper with zinc-plated steel pipes		Bimetallic corrosion (galvanic corrosion) ²⁾ on the zinc-plated steel pipe	<ul style="list-style-type: none"> Compliance with the flow rule: Always install copper in the direction of the water flow downstream of zinc-plated steel pipe
Threaded joints are incorrectly sealed	Excessive tightening	Stress corrosion cracking	<ul style="list-style-type: none"> Do not overtighten the threaded joint
Disinfection of drinking water pipes	An excessive dose of the disinfectant containing chlorine leads to an inadmissibly high chloride content in drinking water	Pitting corrosion Crevice corrosion	<ul style="list-style-type: none"> Strict adherence to the duration of application and prescribed concentration of the disinfectant
Water quality	An excessively high content of water-soluble chloride ions pH value > 7.4 7.4 > pH value > 7.0 and TOC < 1.5 g/m	Internal corrosion	<ul style="list-style-type: none"> Strict adherence to the maximum chloride content of 250 mg/l in drinking water, treated water and cooling water and a conductivity ≤ 2500 µs/cm

1) The corrosion protection must be waterproof, non-porous, resistant to heat and ageing and free of damage.

2) Discolouring caused by deposits of other corrosive products does not indicate any risk of corrosion.

2.8.5 Corrosion behaviour of Geberit Mapress CuNiFe

Resistance to internal corrosion

Corrosion resistance of copper-nickel alloys

Copper-nickel alloys are among the most corrosion-resistant copper product materials.

They are resistant to:

- moisture
- seawater
- non-oxidising acids
- alkalis
- salt solutions
- organic acids
- dry gases (oxygen, chlorine, hydrogen chloride, hydrogen fluoride, sulphur dioxide and carbon dioxide)

Copper-nickel alloys with 10% nickel (Ni) have good resistance to seawater. This also applies to hot seawater and flow speeds of up to 6 m/s.

Resistance of Geberit Mapress CuNiFe to seawater

Geberit Mapress CuNiFe system pipes and fittings made of CuNi10Fe1.6Mn have excellent corrosion resistance, especially to seawater. This high corrosion resistance is due to a natural, thin protective coating that quickly forms upon contact with clean seawater and makes the system pipe corrosion-resistant.

This complex protective coating is mainly made up of copper(I) oxide and is improved by additional nickel and iron. The protective coating forms within a few days but needs up to three months to form fully. The initial contact (exposure) is decisive for the long-term behaviour of copper-nickel, i.e. the pipes must be continually exposed to a flow of clean seawater so that the protective coating can form.

Seawater resistance is a given for:

- cold seawater
- hot seawater
- average flow speeds of up to 6 m/s

If the flow speed for a given geometry is too high, the protective coating may be damaged from the effect of the shearing stress produced by the seawater, and this can lead to impact erosion.

According to DIN EN 85004-2, the flow speed should be between 1 m/s and 3 m/s depending on the diameter.

The iron content of the copper-nickel alloy considerably improves the adhesive strength of the corrosion protection layer and, therefore, resistance to erosive corrosion, particularly in seawater and other aggressive types of water, such as brackish water. Sand abrasion is not easy to quantify, as many factors play a role, such as the sand content of the water, the grain size or the flow profile. The piping systems must be equipped with suitable screening devices for the removal of sand and other residues which could damage the protective foil.

Effect of contaminated seawater

If contaminated seawater containing sulphides comes into contact with the inside of the pipe as the first service water, the sulphides can impair the formation of the protective surface film. The sulphides produce a black surface film containing copper oxide and sulphide. This surface film is not as protective as the protective coating that forms under clean seawater and makes the pipeline susceptible to pitting corrosion.

If an intact copper(I) oxide layer has already formed under the influence of clean seawater, no damage to the protective coating is to be expected from periodic exposure to contaminated water.

Risk of corrosion due to heavy chlorination

Copper-nickel alloys demonstrate good resistance to pitting corrosion. Excessive chlorination of the medium affects the corrosion resistance.

Resistance to chlorine

Geberit Mapress CuNiFe system pipes made of CuNi10Fe1.6Mn are resistant to chlorine in the following concentrations:

	Proportion of free chlorine [ppm]
Continuous chlorination	1
Shock chlorination	5 ¹⁾

1) According to information from EUCARO

Resistance to external corrosion

Due to the seawater resistance of copper-nickel alloys, no external corrosion occurs in Geberit Mapress CuNiFe system pipes when used in salty or humid environments. Protection against external corrosion is therefore not necessary.

Corrosion behaviour of Geberit Mapress CuNiFe in contact with other materials

Geberit Mapress CuNiFe is compatible with other copper alloys. In combination with other materials such as aluminium or steel, it can cause bimetallic corrosion, which can be prevented through galvanic isolation of the various materials, for example, with a plastic plate.

2.9 PIPE LAYING

2.9.1 Basic laying process

The following sequence applies for the laying of Geberit pressing systems:

1. Fasten the pipes in sliding brackets.
2. Connect the pipes and pressfittings.
3. Press the pipes and pressfittings.

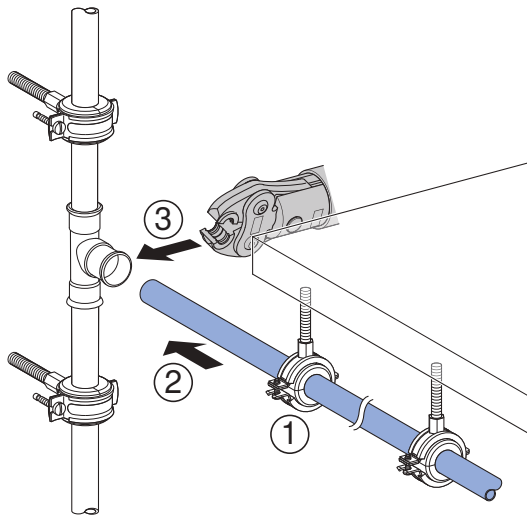

Pressed pipes must be kept tension-free during the installation (e.g. with pipe brackets).

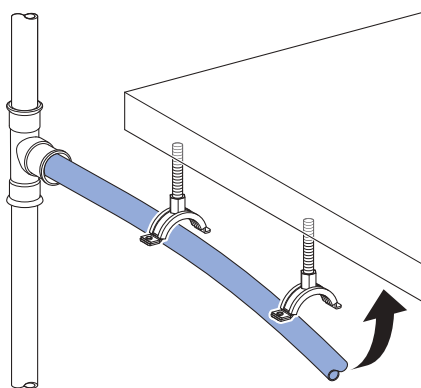

2.9.2 Storey distribution

Individual supply pipe system

With an individual supply pipe system, each point of use is connected to a separate feed pipe from the floor manifold.

This installation method is selected if these are short pipe lengths between the manifold and the points of use.

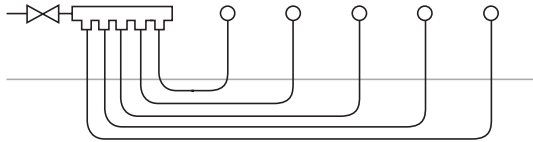

Figure 201: Individual supply pipe system

Advantages:

- Minimal planning and calculation work required
- Small pipe cross-sections
- Low water content per pipe
- Minimised pressure losses
- Individual connection for higher water requirements
- Quick and easy pipe installation
- Clear direction of flow

Disadvantages:

- Risk of stagnation if all points of use are not used regularly
- Points of use must be used regularly
- Greater space requirements for pipes and floor manifold
- Longer pipe lengths

Block pipe system

Matching sanitary connections such as a washbasin and WC exit a common floor manifold as several series connections. The connections are either single or double connections.

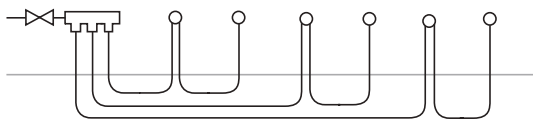

Figure 202: Block pipe system

Advantages:

- Shorter pipe lengths
- Low space requirements for floor manifold
- Minimal planning and calculation work required
- Rarely used points of use can be looped through frequently used points of use
- Clear direction of flow

Disadvantages:

- Higher pressure loss
- For larger diameters, it may be more difficult to maintain the draw-off times

Series-connected pipe system

The pipe is routed from one point of use to the next with double connections. Points of use are combined in groups and supplied by a common pipe.

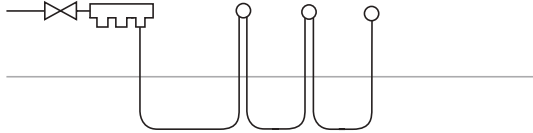

Figure 203: Series-connected pipe system

Advantages:

- Minimal planning and calculation work required
- Shorter pipe lengths
- Low space requirements for floor manifold
- Lower stagnation volume due to fast water replacement
- Good drinking water hygiene when the last point of use is regularly used
- Clear direction of flow

Disadvantages:

- Higher pressure loss
- There must be a larger point of use at beginning of the series
- For larger diameters, it may be more difficult to maintain the draw-off times

Circular pipe system

In a circular pipe system, the points of use are connected to each other via double connections, as in a series-connected pipe system. The pipe leads back to the manifold from the last point of use. The potable water flows from two sides while water is drawn off and therefore flows through all connections.

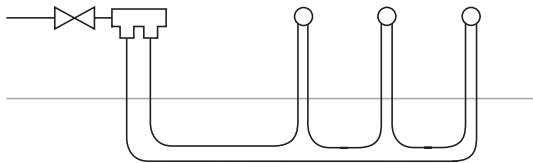

Figure 204: Circular pipe system

Advantages:

- Lower pressure loss enables higher water draw-off and considerably more points of use with the same size pipe cross-section
- Various points of use can be connected at greater distances from the floor manifolds or riser pipes
- Low space requirements for floor manifold

Disadvantages:

- Direction of flow and flow through all sections not clear
- Complex calculation
- For larger diameters, it may be more difficult to maintain the draw-off times

Combined pipe system

The individual supply pipe, series-connected pipe and circular pipe variants can be combined.

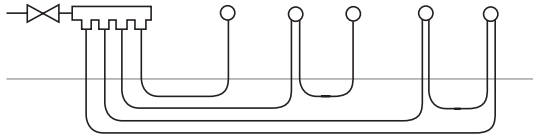

Figure 205: Combined pipe system

Installation examples of a high-standard apartment:

- Individual supply pipe for a shower. If possible, connect at the start of the floor manifold.
- Series-connected pipe for a washbasin and WC
- Circular pipe in systems with increased drinking water hygiene requirements

Advantages:

- Pipe layout can be adapted to the respective requirements
- Low pressure losses
- Minimised risk of stagnation
- Optimum water replacement at draw-off points which are not often used

Disadvantage:

- More complex calculation

2.9.3 Installation on uncovered concrete floors

In addition to country-specific regulations, the following rules must be observed for installations on uncovered concrete floors:

- In order to facilitate the installation of impact sound insulation, pipes laid on the uncovered concrete floor should be arranged and, if possible, routed next to each other.
- It is important to check whether the pipes on the uncovered concrete floor need to be defined in accordance with the national regulations.
- In order to minimise heat transfer when cold and hot water pipes are laid next to each other, a minimum distance of 10 cm should be maintained between the pipes.
- Compensation measures are necessary above the pipes to create a flat surface to accommodate the insulating layer or at least a sound insulation layer. The necessary construction height must be included in plans.

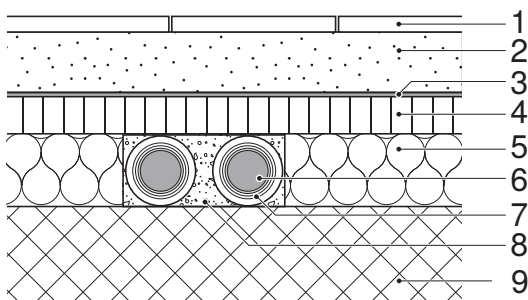

Figure 206: Pipe laying on uncovered concrete floors

- 1 Top layer
- 2 Cast plaster floor
- 3 Film
- 4 Impact sound insulation
- 5 Thermal insulation
- 6 System pipe
- 7 Pipe insulation
- 8 Cavity filling (e.g. Perlite or Meabitt)
- 9 Uncovered concrete floor

2.10 PIPE FIXATION

2.10.1 Fastening of pipes with anchor and sliding points

Pipe fastenings support the pipe and direct the temperature-related changes in length in the required direction. Distinctions are made between pipe fastenings based on anchor points and sliding points.

An anchor point is a rigid pipe installation which directs the pipe expansion to an expansion compensator.

A sliding point is an axially movable pipe bracket.



Sliding points must be set so that they do not become unwanted anchor points during operation.

2.10.2 Pipe bracket spacing for drinking water installations

Surface-mounted Geberit Mapress Stainless Steel system pipes are fastened with pipe brackets. Geberit pipe brackets, insulated, can be used to prevent the transmission of structure-borne sound.

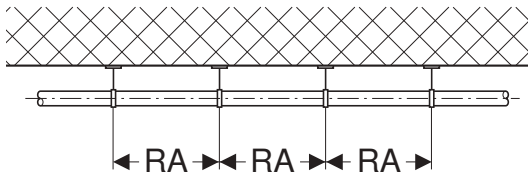

The following table lists the maximum pipe bracket spacing recommended by Geberit as well as the distances for Geberit Mapress Stainless Steel according to EN 806-4:2010.

Table 87: Maximum pipe bracket spacing and load per pipe bracket for Geberit Mapress Stainless Steel for drinking water installations

d [mm]	RA ¹⁾ As recommended by Geberit [m]	F [N]	RA According to DIN EN 806-4	F [N]
12	1.5	5.3	1.0	3.5
15	1.5	7.3	1.0	4.8
18	1.5	9.4	1.2	7.5
22	2.5	23.2	1.8	16.7
28	2.5	33.0	1.8	23.8
35	3.5	72.2	2.4	49.5
42	3.5	95.1	2.4	65.2
54	3.5	140.6	2.7	108.4
76.1	5.0	389.8	3.0	233.9
88.9	5.0	500.8	3.0	300.5
108	5.0	690.4	3.0	414.3

RA Pipe bracket spacing

F Load per pipe bracket, pipe filled with water at 10 °C

1) Different pipe bracket spacing applies for sprinkler, extinguishing and gas installations.

2.10.3 Pipe bracket spacing for sprinkler and extinguishing water systems

The following table includes the maximum pipe bracket spacing according to VdS CEA 4001:2021-01, which is also recommended by Geberit.

Table 88: Maximum pipe bracket spacing RA and load per pipe bracket, sprinkler and extinguishing water systems

d [mm]	RA [m]	F ²⁾ [N]
	According to VdS CEA 4001:2021-01 ¹⁾	
22	2.0	18.6
28	2.0	26.4
35	2.0	41.3
42	2.0	54.4
54	2.0	80.3
76.1	2.0	156.0
88.9	2.0	200.4
108	2.0	276.2

F Load per pipe bracket

1) and Geberit recommendation

2) Pipe, filled with water, 10 °C

2.10.4 Thickness of the pipe fixation for sliding points

Pipe brackets are fastened to the wall or ceiling with threaded rods or threaded pipes. The required thickness of the pipe bracket fastenings must be selected depending on the ceiling or wall distance.

Table 89: Required thickness of the pipe bracket fastenings of sliding points on ceilings and walls

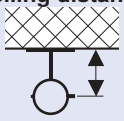
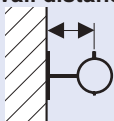
d [mm]	Distance between pipe brackets [cm]						
	Ceiling distance 					Wall distance 	
	≤ 10	11–20	21–30	31–40	41–60	≤ 10	11–20
12	M8	M8	M8	M10	M10	M8	M10
15	M8	M8	M8	M10	M10	M8	M10
18	M8	M8	M10	M10	M10	M8	M10
22	M8	M10	1/2"	1/2"	1/2"	M10	M10
28	M10	M10	1/2"	1/2"	1/2"	M10	M10
35	M10	M10	1/2"	1/2"	1/2"	M10	1/2"
42	1/2"	1/2"	1/2"	1/2"	1/2"	1/2"	1/2"
54	1/2"	1/2"	1/2"	1/2"	1/2"	1/2"	1/2"
76.1	1/2"	1/2"	1/2"	1/2"	1/2"	1/2"	1/2"
88.9	1/2"	1/2"	1/2"	1/2"	1/2"	1/2"	1/2"
108	1/2"	1/2"	1/2"	1/2"	1/2"	1/2"	1/2"

2.10.5 Installation dimensions of Geberit mounting plates

Geberit mounting plates are used to fasten Geberit connections.

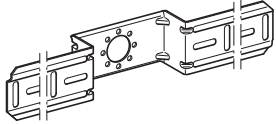
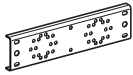
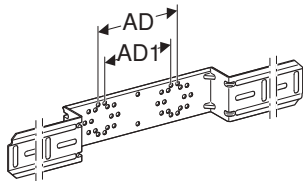
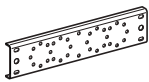
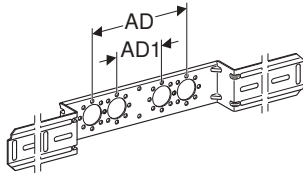
Geberit mounting plate		Number of possible connections	AD [cm]	AD1 [cm]
Straight	Offset			
		1	–	–
		2	12	10
		2	15.3	7.3

AD Connecting distance

Different installation dimensions and depths are achieved with concealed and exposed installation of Geberit mounting plates.

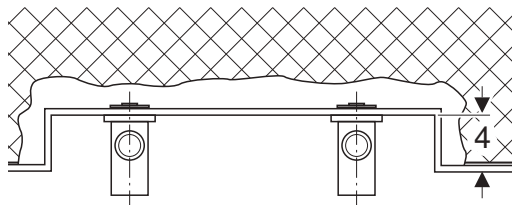

Figure 207: Installation dimension for concealed installation with a Geberit mounting plate, offset

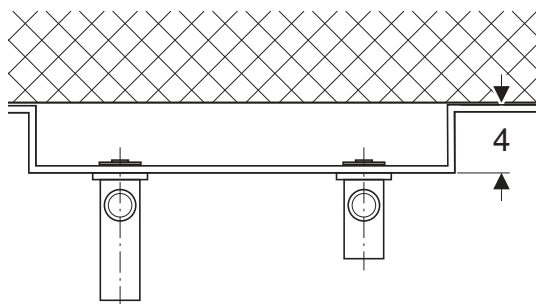

Figure 208: Installation dimension for exposed installation with a Geberit mounting plate, offset

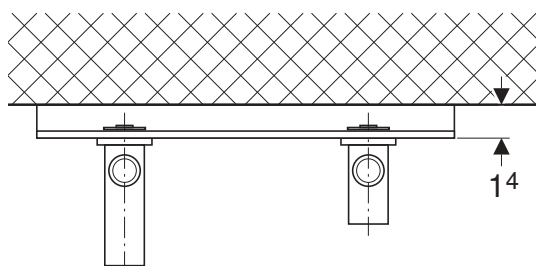
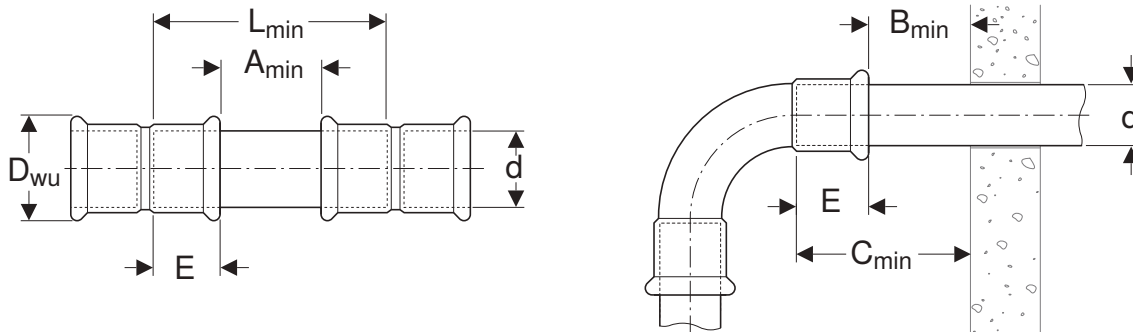

Figure 209: Installation dimension for exposed installation with a Geberit mounting plate, straight

2.10.6 Minimum distances for pressing

In order to avoid damage to already pressed connections or to permit the correct pressing of pipes and fittings, the following distances must be maintained between 2 pressing operations and for wall and ceiling feed-throughs:



- d Outer pipe diameter
- D_w Outer fitting bead diameter
- u
- L_{min} Minimum length of the system pipe
- A_{min} Minimum distance between 2 fittings
- B_{min} Minimum distance from the fitting to the wall
- C_{min} Minimum depth of the system pipe
- E Insertion distance





d [mm]	D _{wu} [mm]	L _{min} [cm]	A _{min} [cm]	B _{min} [cm]	C _{min} [cm]	E [cm]
12	20	4.4	1.0	3.5	5.2	1.7
15	20	5.0	1.0	3.5	5.2	2.0
18	26	5.0	1.0	3.5	5.5	2.0
22	32	5.2	1.0	3.5	5.5	2.1
28	38	5.6	1.0	3.5	5.6	2.3
35	45	6.2	1.0	3.5	5.8	2.6
42	54	8.0	2.0	3.5	6.1	3.0
54	66	9.0	2.0	3.5	6.5	3.5
66.7	84	12.0	2.0	3.0	7.0	5.0
76.1	95	12.6 ¹⁾ /13.6 ²⁾	2.0 ¹⁾ /3.0 ²⁾	7.5	12.8	5.3
88.9	110	14.0 ¹⁾ /15.0 ²⁾	2.0 ¹⁾ /3.0 ²⁾	7.5	13.5	6.0
108	133	17.0 ¹⁾ /18.0 ²⁾	2.0 ¹⁾ /3.0 ²⁾	7.5	15.0	7.5

- 1) The dimensions apply for pressing operations with Geberit pressing attachments with compatibility [1], [2], [2XL], [3] and [4].
- 2) The dimensions apply for pressing operations with Geberit pressing attachments with compatibility HCP.

2.10.7 Space requirements when pressing with Geberit Mapress pressing jaws

The following minimum distances must be observed for pressing in cramped conditions, for example, in ducts or pipework, in order to be able to fit the pressing tool correctly.

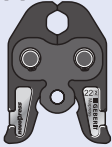
Table 90: Space requirements for pressing jaws with compatibility [1] and [2], maximum dimension

Compatibility/pressing jaw	Mounting on a smooth wall			Mounting in a corner			Mounting in a duct		
	d [mm]	A [cm]	C [cm]	A [cm]	B [cm]	C [cm]	A [cm]	C [cm]	D [cm]
	12	1.8	4.6	2.4	3.7	5.5	2.4	5.5	12.9
	15	2.1	5.0	2.5	3.7	5.5	2.5	5.5	12.9
	18	2.3	5.1	2.5	4.0	5.5	2.5	5.5	13.5
	22	2.4	6.1	2.7	4.4	6.3	2.7	6.3	15.1
	28	2.7	6.5	3.2	4.6	6.9	3.2	6.9	16.1
	35	3.1	8.1	3.6	5.6	8.2	3.6	8.2	19.4
	12	2.2	5.5	2.6	4.4	6.1	2.6	6.1	14.9
	15	2.4	5.6	2.5	4.8	6.0	2.5	6.0	15.6
	18	2.6	5.9	2.9	4.5	6.6	2.9	6.6	15.6
	22	2.6	6.4	3.1	4.8	6.8	3.1	6.8	16.4
	28	3.0	7.4	3.4	5.4	7.5	3.4	7.5	18.3
	35	3.5	8.4	3.9	6.0	8.5	3.9	8.5	20.5
	12	2.2	4.8	2.8	4.0	5.5	2.8	5.5	13.5
	15	2.4	5.0	2.9	4.1	6.2	2.9	6.2	14.4
	18	2.6	5.0	2.6	3.9	6.0	2.6	6.0	13.8
	22	2.9	6.2	3.2	4.9	6.9	3.2	6.9	16.7
	28	3.0	6.5	3.0	4.4	6.9	3.0	6.9	15.7
	35	3.4	7.5	3.7	5.5	7.6	3.7	7.6	18.6
	12	2.2	5.4	2.5	4.5	6.2	2.5	6.2	15.2
	15	2.4	5.5	2.6	4.5	6.2	2.6	6.2	15.2
	18	2.6	5.9	2.9	4.5	6.5	2.9	6.5	15.5
	22	2.9	6.3	3.3	4.8	6.8	3.3	6.8	16.4
	28	3.0	7.0	3.6	5.0	7.5	3.6	7.5	17.5
	35	3.4	8.2	4.0	5.9	8.4	4.0	8.4	20.2

2.10.8 Space requirements when pressing with Geberit Mapress pressing collars

The following minimum distances must be provided for pressing with Geberit Mapress pressing collars in order to be able to position the pressing tool correctly.

Table 91: Space requirements when pressing with pressing collars with compatibility [2]/[3], [2XL]/[3] and [4]

Compatibility/pressing collar	Mounting on a smooth wall			Mounting in a corner			Mounting in a duct		
	d [mm]	A [cm]	C [cm]	A [cm]	B [cm]	C [cm]	A [cm]	C [cm]	D [cm]
	35	7.5	11.5	7.5	7.5	11.5	7.5	11.5	26.5
	42	7.5	11.5	7.5	7.5	11.5	7.5	11.5	26.5
	54	8.5	12.0	8.5	8.5	12.0	8.5	12.0	29.0
	66.7	9.5	14.0	9.5	9.5	14.0	9.5	14.0	33.0
	76.1	11.5	15.5	11.0	11.5	15.5	11.0	15.5	38.0
	88.9	12.5	16.5	12.0	12.5	16.5	12.0	16.5	41.0
	108	14.5	18.5	14.0	14.5	18.5	14.0	18.5	47.0
	76.1	11.5	16.0	11.5	11.5	16.0	11.5	16.0	39.0
	88.9	13.0	18.0	13.0	13.0	18.0	13.0	18.0	44.0
	108	15.0	20.0	15.0	15.0	20.0	15.0	20.0	50.0

2.10.9 Space requirements when pressing with Geberit pressing tool HCPS

d [mm]	Complete premounting					Mounting of the individual system sections			
	A [cm]	B [cm]	C [cm]	D [cm]	E [cm]	A [cm]	B [cm]	C [cm]	F [cm]
76.1	11.0	20.0	22.0	22.0	30.0	11.0	16.0	16.0	60
88.9	12.0	20.0	22.0	22.0	32.0	12.0	16.0	18.0	60
108	13.0	20.0	23.0	23.0	34.0	13.0	16.0	20.0	60

2.11 PIPEWORK

2.11.1 Processing temperature

The Geberit Mapress piping systems can be processed at ambient temperatures of -20 °C to 60° C.

2.11.2 Cutting of bare system pipes to length

The following are suitable for cutting Geberit Mapress system pipes to length:

- Geberit Mapress pipe cutter R
- Fine-toothed hand mitre saw
- Pipe cutter with electric motor
- Electric saw (e.g. Rothenberger Pipecut, Orbitalum RA 41 Plus)

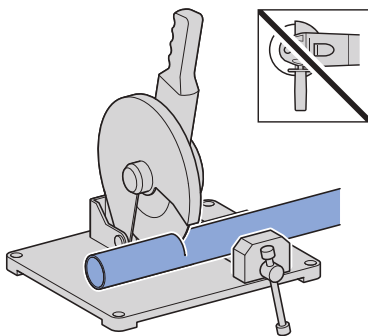
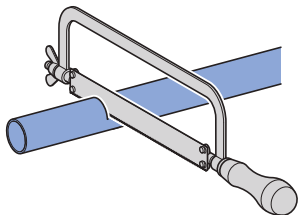
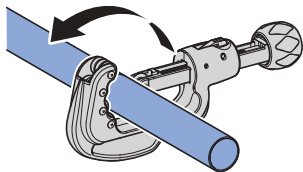

Figure 210: Suitable cutting tool

The use of abrasive cut-off wheels and cutting pipes to length using a welding torch are inadmissible due to the uncontrolled thermal effect on the cut surfaces and the resulting risk of corrosion.

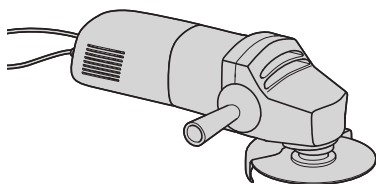

Figure 211: Inadmissible cutting tool

The following must be observed when cutting pipes to length:

- The inside of the pipe must be free of foreign bodies such as plastic foils, inserted protection plugs, etc.
- Only use a cutting tool suitable for the material.
- The cut surfaces must be smooth to prevent damage to the seal ring in the fitting.
- The pipes must be cut professionally, completely and at a right angle. It is not admissible to break off a pipe that has not yet been completely cut to length.

2.11.3 Cutting of system pipes with a plastic jacket to length

Electric saws are particularly suitable for cutting Geberit Mapress system pipes with a plastic jacket to length. When cutting with a pipe cutter, the plastic jacket can become compressed or raised.

Damage to the plastic jacket when using a pipe cutter depends on the following factors:

- pipe dimension
- pipe length
- temperature
- construction of the pipe cutter

When using a pipe cutter, Geberit therefore recommends removing the plastic jacket in the area of the counterpressure rollers of the pipe cutter before cutting the pipe to length.

The Geberit Mapress stripping tool is normally used to strip pipes. The stripping device is set at the factory to the correct dimension of the insertion distance.

Alternatively, the plastic jacket can be marked with the pipe cutter and carefully slit with a universal cutter. It is important to ensure that the pipe surface in the subsequent seal ring area is not damaged and that the correct insertion distance is maintained. In the case of systems requiring approval, the correct insertion distance must also be marked with a marker pen on the plastic jacket.

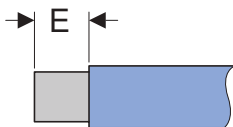
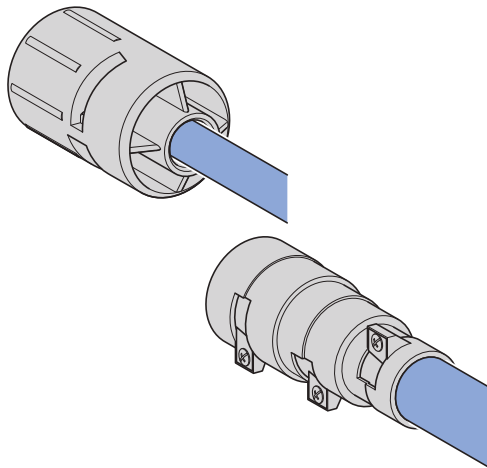

Figure 212: Stripping with the Geberit Mapress stripping tool.

2.11.4 Deburring of system pipes

Depending on the pipe dimension, Geberit Mapress system pipes must be deburred with a manual deburrer, such as the Geberit Mapress pipe deburrer or the Geberit Mapress electric pipe deburrer RE 1.

The Geberit Mapress pipe deburrer is available in the following designs:

- for d12–35 mm, art. no. 90357
- for d12–54 mm, art. no. 90363

The Geberit Mapress electric pipe deburrer RE 1 is compatible with the pipe dimensions d15–108 mm, art. no. 691.000.P3.3.

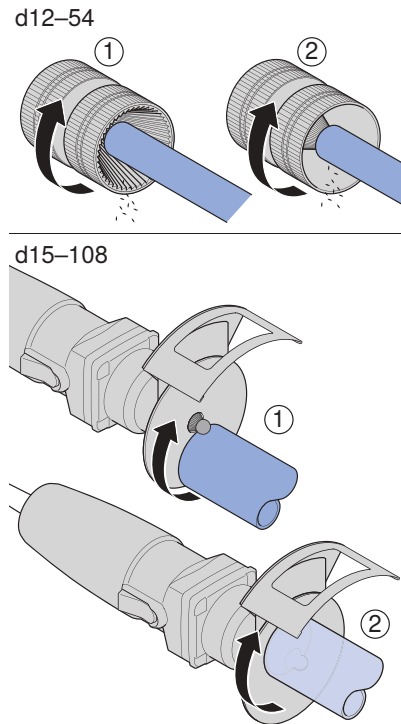
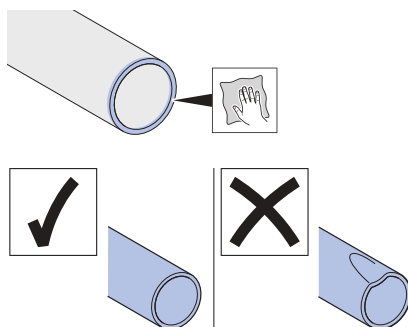

Figure 213: Deburring with a manual deburrer or with an electric pipe deburrer

The following must be observed when deburring and chamfering the cut edges:

- The deburring tool must be free of chips.
- The lowest rotational frequency must be set when deburring with the electric pipe cutter.
- The cut edges must be carefully deburred on the inside and outside.
- The inside of the pipe must be free of foreign bodies such as residual plastic foil or a protection plug.
- The pipe ends must be completely free of chips to prevent damage to the seal in the fitting.
- The pipe ends must be checked to ensure that they are intact after deburring.



2.11.5 Bending system pipes

The following rules apply for bending Geberit Mapress system pipes:

- Pipes are only suitable for cold bending. The heating process changes the structure of the material, which can lead to intercrystalline corrosion.
- Pipes can only be bent with standard bending tools.
- From a pipe dimension of d54 mm, special tools are required for bending, which are offered by specialist manufacturers.
- The regulations of the bending tool manufacturer must also be observed for the suitability of the bending tool and determination of the bending radius.

Smallest bending radius for Geberit Mapress system pipes:

- bending by hand: $r \geq 5 \cdot d$
- bending with a bending tool: $r \geq 3.5 \cdot d$

2.11.6 Determination of the insertion distance

In order to create a secure pressed joint, the insertion distance must be determined and marked on the pipe before the pipe and fitting are connected together.

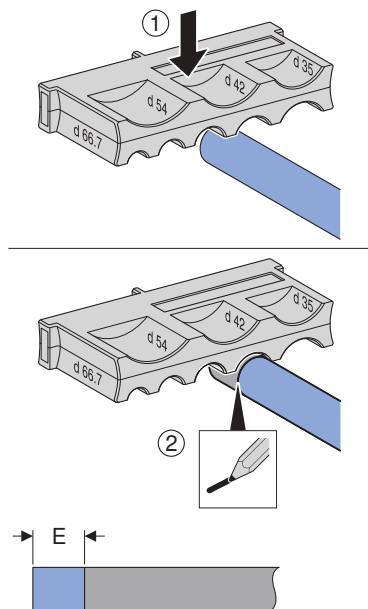

Figure 214: Marking of the insertion distance



The strength of the connection is only achieved by maintaining the specified insertion distance.

The marking of the insertion distance must be visible on the pipe after inserting the pipe into the pressfitting and after pressing it.

On fittings with a plain end, the insertion distance must be marked on the plain end.

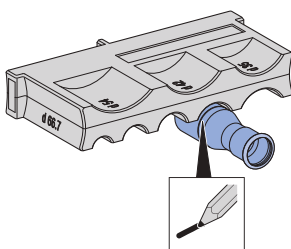

Figure 215: Marking of the insertion distance on fittings with a plain end



Pressfittings with a plain end, such as bends with plain ends, may only be shortened up to the minimum admissible leg length.

2.12 PRESSING PREPARATIONS

To avoid any impurities, only pressfittings with protection plugs should be used.

The following must be observed prior to the pressing:

- The protection plug must only be removed immediately before the pressfitting is pushed onto the pipe.

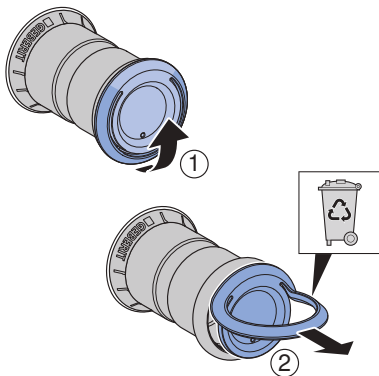

- The seal ring must be correctly positioned.
- When replacing the seal ring, it must not be damaged, for example, by using pointed or sharp-edged objects.
- The seal ring must be free of foreign bodies.

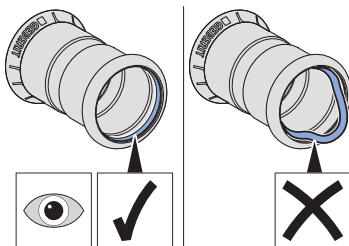

- No lubricant must be applied to the pressfitting.

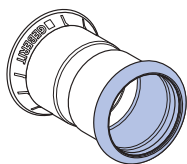
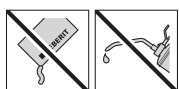

- The fitting must be pushed onto the pipe by turning it slightly in the axial direction up to the marked insertion distance.
- To prevent damage to the seal ring, the pipe must not be prised into the pressfitting.

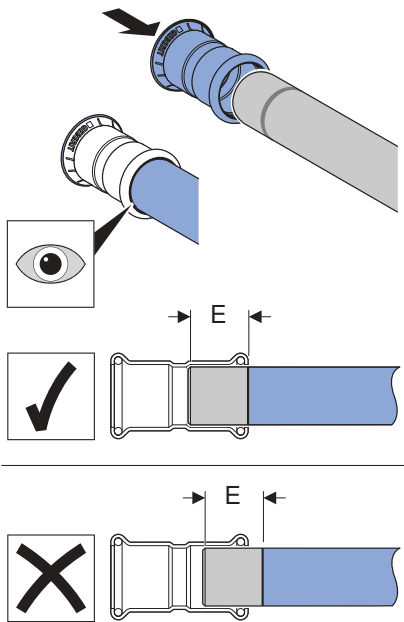

Figure 216: Marking on the pipe to check the correct insertion distance



Prising the pipe into the pressfitting can damage the seal ring and cause the pressed joint to leak.

In order to maintain the specified insertion distance, the pipes must be fixed accordingly. For pipe dimensions d_{54} –108 mm, the Geberit Mapress mounting aid can be used to fix the pipes.

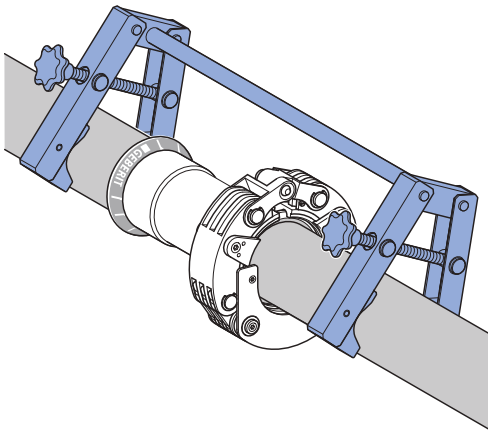

Figure 217: Geberit Mapress mounting aid MH1

2.12.1 Connection with a threaded fitting

Threaded fittings must be sealed and screw-locked with a suitable sealant before the pressing operation.

2.12.2 Alignment of pipes

The following rules apply for the alignment of pipes:

- The pipes or the prefabricated components must be aligned before the pressing operation.
- Dust or dirt particles must not enter the press nip during the alignment. These particles could lead to a leaky connection after the pressing operation.
- Lifting of the pipe after the pressing operation is permitted if the pressed joints are not loaded.
- Alignment after the pressing operation is possible if the pressed joints are not loaded.

2.13 CREATING A PRESSED JOINT

i For information on the pressing of Geberit Mapress system pipes and pressfittings, see the pressing tool operation manuals as well as the Geberit Mapress pressing jaw and pressing collar user manuals.

i The Geberit Mapress system components must not be processed when ambient temperatures are below $-20\text{ }^{\circ}\text{C}$. Pressing tools with a rechargeable battery can only be used in temperatures ranging from -10 to $+50\text{ }^{\circ}\text{C}$.

Before a pressed joint is created, the pipe or prefabricated components must be aligned and the screwing joints sealed. During the pressing operation, the guide for the pressing jaw or pressing collar must be positioned on the fitting groove.

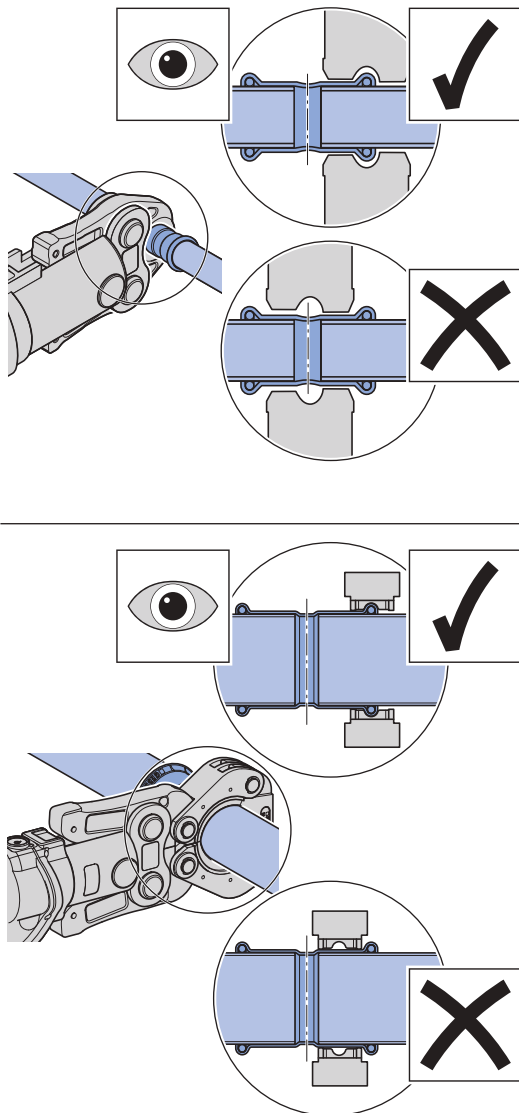

Figure 218: Positioning of the Geberit Mapress pressing jaw and pressing collar

After the pressing operation, the pressing indicator is removed from the pressfitting.

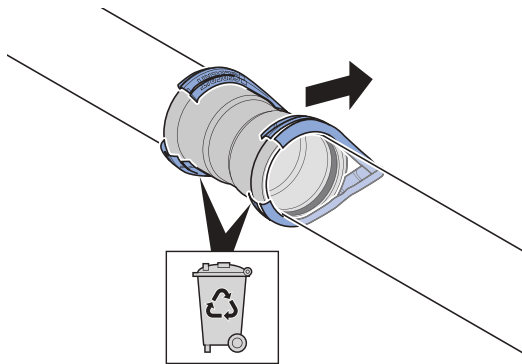

Figure 219: Removing the pressing indicator

You can identify that a pressing operation has been carried out correctly as follows:

- the mark indicating the insertion distance is visible
- the pressing indicator is removed

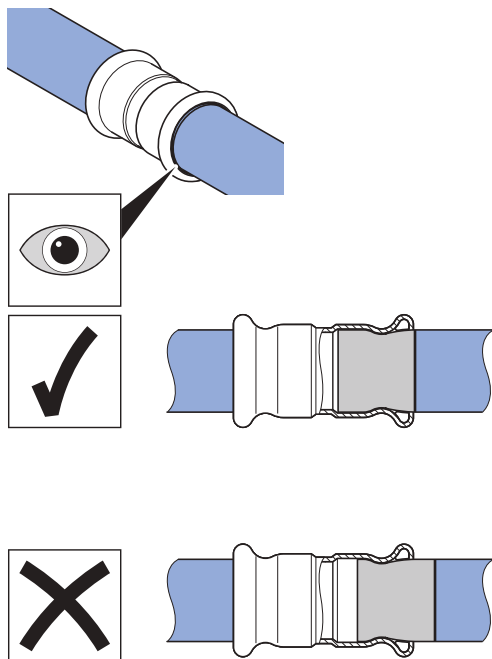

Figure 220: Correct pressing operation

2.13.1 Pressing operation for the dimension d108 mm

This section contains some basic information about pressing the dimension d108 mm, which is different from pressing the other dimensions.

For detailed information on the pressing collar and the adapter jaws as well as the operation, see the user manual [2XL] / [3], document number 967.040.00.0(01). The user manual also contains step-by-step instructions for pressing operations.

Pressing with the Geberit pressing collar \varnothing 108 mm is performed in two stages with two different adapter jaws:

- preliminary pressing with a pressing collar and adapter jaw ZB 323 with a compatibility mark 3 or ZB 221 with a compatibility mark 2XL
- final pressing with a pressing collar and adapter jaw ZB 324 with a compatibility mark 3 or ZB 222 with a compatibility mark 2XL

Structure of the Geberit Mapress pressing collar [2XL] / [3], d108 mm

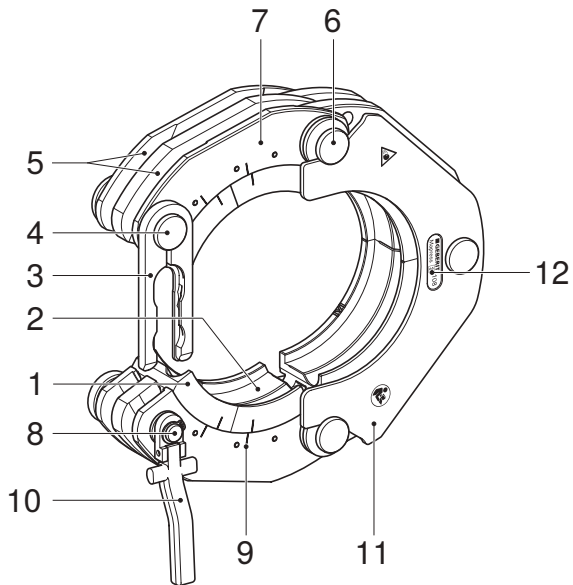
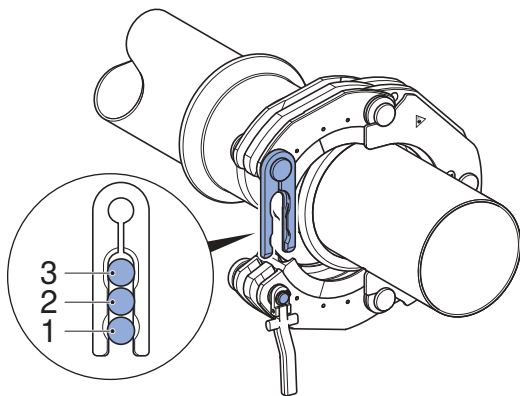

Figure 221: Geberit Mapress pressing collar \varnothing 108 mm

- 1 Sliding segments
- 2 Pressing contour
- 3 Locking lug
- 4 Pins and contact
- 5 Grooves
- 6 Collar joints
- 7 Segment shells
- 8 Locking pin with contact
- 9 Marks
- 10 Release lever
- 11 Centring plate
- 12 Compatibility mark

The position of the locking pin in the locking lug displays the status of the pressing procedure:

- position 1: the pressing collar is positioned
- position 2: the connection has undergone preliminary pressing
- position 3: the connection has undergone final pressing



2.14 PRESSING TOOLS

A pressing tool is defined as a pressing tool with a pressing attachment inserted. Pressing jaws, adapter jaws and pressing collars are designated as pressing attachments.

Geberit pressing tools and pressing attachments are specifically designed for pressing Geberit system pipes and fittings. Using Geberit pressing tools or the pressing tools from other manufacturers recommended by Geberit together with the original Geberit pressing attachments is a prerequisite for the additional Geberit warranty.

2.14.1 Pressing tools and pressing attachments

The suitable pressing attachment is inserted into the pressing tool for pressing the pipe and fitting.

The following pressing attachments are used depending on the pipe diameter:

- pressing jaws for pipe diameters $\leq d35$
- pressing collars with adapter jaws for pipe diameters $\geq d35$

The pressing contour of the Geberit pressing jaws and pressing collars has been designed to suit the geometry of the Geberit pressfittings.

2.14.2 Maintenance and service plans for Geberit Mapress pressing jaws

The maintenance regulations for zinc-plated Geberit Mapress pressing jaws are different from those without zinc plating. The zinc-plated pressing jaws with compatibility [1] and [2] are service-free, i.e. they do not require a service by an authorised repair shop if they are used as intended. The black pressing jaws with compatibility [1], [2] and [3] are subject to a service and require an annual service by an authorised repair shop.

All pressing jaws must be regularly maintained. Pressing jaws that are not maintained, or are not professionally maintained, can cause accidents and injuries.

The intervals listed in the table as well as the maintenance and service work must be followed.

Table 92: Maintenance plan for service-free Geberit Mapress pressing jaws with compatibility [1] and [2]

		Interval	Work
User maintenance		Regularly (before use, at the start of the working day)	<ul style="list-style-type: none"> ▶ Check the Geberit pressing jaw for external safety-relevant defects and damage (e.g. incipient cracks, rust spots) and replace if defective. ▶ Remove deposits in the pressing contour. ▶ Spray the pressing contour with BRUNOX® Turbo-Spray® or similar and clean with a cloth. ▶ Examine whether the jaw levers can move easily. If necessary, move the adapter jaw levers several times until they are able to move easily.
		Every six months	<ul style="list-style-type: none"> ▶ Check that the Geberit pressing jaw is fully closed and has sufficient press capacity using the Geberit PowerTest. If defects are detected during the check, the pressing jaw, pressing tool and PowerTest must be sent to an authorised repair shop.



The service-free Geberit Mapress pressing jaws and the service-free adapter jaw 203A do not get a service sticker. The test is documented through the Geberit PowerTest.

Table 93: Maintenance and service plan for Geberit Mapress pressing jaws with compatibility [1], [2] and [3] that are subject to a service

		Interval	Work
User maintenance		Regularly (before use, at the start of the working day)	<ul style="list-style-type: none"> ▶ Check the Geberit pressing jaw for external safety-relevant defects and damage (e.g. incipient cracks, rust spots) and replace if defective. ▶ Clean and lubricate the pressing jaws, see the user manual. ▶ Check screw connections if present and retighten if necessary. ▶ Examine whether the jaw levers can move easily. If necessary, spray the jaw joints with BRUNOX® Turbo-Spray® and move them around. ▶ Wipe off any excess lubricant. ▶ Spray the pressing contour and joints with BRUNOX® Turbo-Spray®. After a short application time, remove any dirt and deposits with a cloth. ▶ Spray the entire pressing jaw with BRUNOX® Turbo-Spray® or similar.
Service by a repair shop		Annually	<ul style="list-style-type: none"> ▶ Arrange for an authorised repair shop to check the state of wear.

i A service sticker on the pressing tool, pressing jaw, adapter jaw and pressing collar indicates the date when the next service is due.



Arrange for the pressing tool (type ACO pressing tools with a battery charger) to be sent for a service together with the pressing jaws, adapter jaws and pressing collars in the transport case.

i The addresses of authorised repair shops can be requested from the Geberit sales companies.

2.14.3 Using the Geberit PowerTest

i Check the pressing jaw for cracks and take the necessary measures.

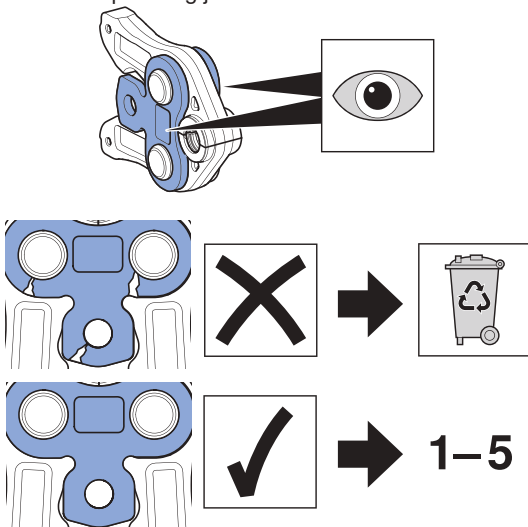

1 Clean the contour of the pressing jaw.

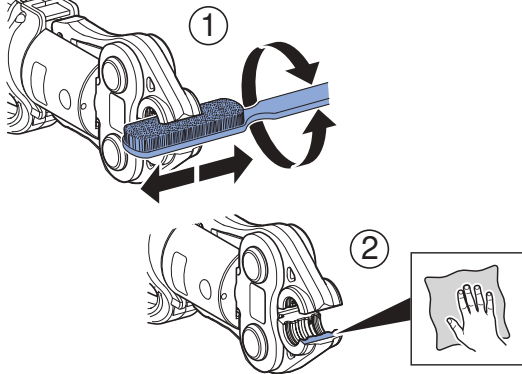

2 Prepare the PowerTest.



i Remove the pressing indicator before a pressing operation with the PowerTest.

Geberit Mapress

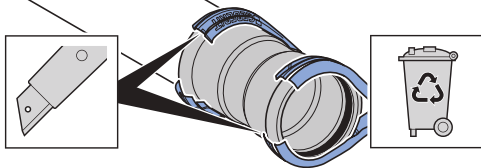

3 Stick the PowerTest to the pressing jaw.

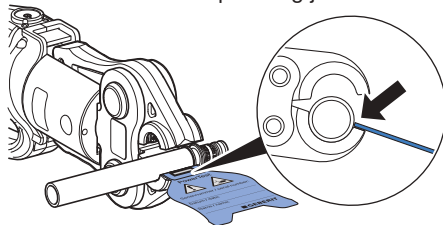

4 Perform the pressing operation with the PowerTest.

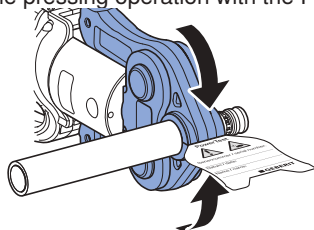

5 Remove and evaluate the PowerTest.

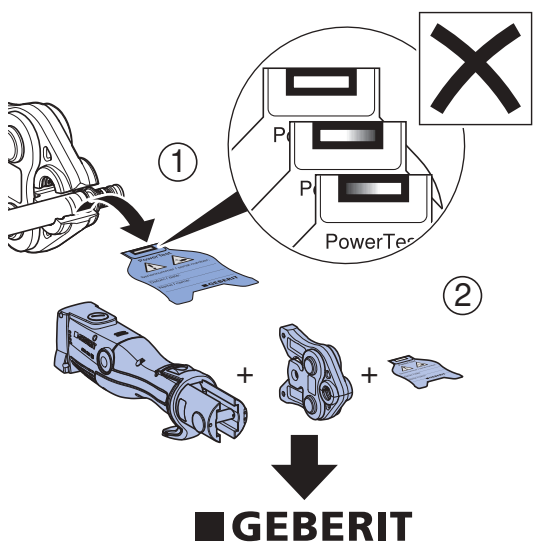
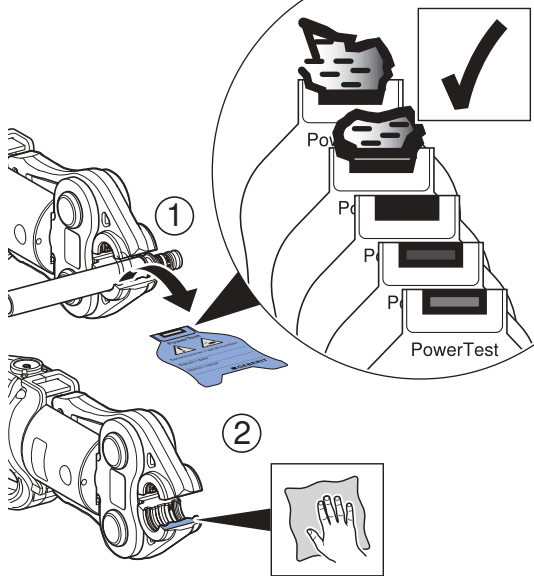

2.14.4 Maintenance plan for the service-free adapter jaw 203 A

The Geberit Mapress adapter jaw ZB 203A must be regularly maintained by the user. It is not necessary for this adapter jaw to be sent to an authorised repair shop.

Table 94: Maintenance plan for the service-free Geberit adapter jaw ZB 203A with compatibility [2]

		Interval	Maintenance
User maintenance	ZB 203A [2] 	Regularly (before use, at the start of the working day)	<ul style="list-style-type: none"> ▶ Check the Geberit adapter jaw ZB 203A for external safety-relevant defects and damage (e.g. incipient cracks, rust spots) and replace if defective. ▶ Spray the entire adapter jaw with BRUNOX® Turbo-Spray® and clean with a cloth. ▶ Examine whether the jaw levers can move easily. If necessary, move the jaw levers several times until they are able to move easily.

2.14.5 Maintenance and service plans for Geberit Mapress pressing collars and adapter jaws

Geberit Mapress pressing collars and adapter jaws must be regularly maintained and tested by an authorised repair shop. An exception is the Geberit Mapress ZB 203A adapter jaw, which is maintained by the user. The ZB 203A is not sent to a repair shop.

Pressing collars and adapter jaws that are not maintained, or are not professionally maintained, can cause accidents and injuries.

The intervals listed in the table as well as the maintenance and service work must be followed.

i A service sticker on the pressing tool, pressing jaw, adapter jaw and pressing collar indicates the date when the next service is due.



Arrange for the pressing tool (type ACO pressing tools with a battery charger) to be sent for a service together with the pressing jaws, adapter jaws and pressing collars in the transport case.

i The addresses of authorised repair shops can be requested from the Geberit sales companies.

Table 95: Maintenance and service plan for Geberit Mapress pressing collars and adapter jaws [2], [2XL], [3] and [4]

		Interval	Work
User maintenance	All pressing collars and all adapter jaws with compatibility [2], [2XL], [3] and [4] 	Regularly (before use, at the start of the working day)	<ul style="list-style-type: none"> ▶ Check the pressing collar and adapter jaw for external safety-relevant defects and damage (e.g. incipient cracks, rust spots) and replace if defective or arrange for the defects to be repaired by an authorised repair shop. ▶ Check screw connections and retighten if necessary. ▶ Examine whether the jaw levers can move easily. If necessary, spray the jaw joints with BRUNOX® Turbo-Spray® or similar and move them around. Wipe off any excess lubricant. ▶ Spray the pressing contour with BRUNOX® Turbo-Spray® or similar, leave for a short application time and remove dirt and deposits with a cloth. ▶ Lubricate joints and interlocks with BRUNOX® Turbo-Spray® or similar and move them around until they can move easily. Wipe off any excess lubricant. ▶ Spray BRUNOX® Turbo-Spray® or similar between the sliding segments and shells and move them around until they can move easily. Wipe off any excess lubricant. ▶ Lightly spray the entire adapter jaw and pressing collar with BRUNOX® Turbo-Spray® or similar.
	Pressing collars [3] ZB [3]		
Service by a repair shop	Pressing collars [2XL] ZB 201 ZB 301 Pressing collars [2] to 12-2011 ZB 221 ZB 222 Pressing collars [3] and [4] ZB 321 ZB 322 ZB 323 ZB 324	Annually	<ul style="list-style-type: none"> ▶ Arrange for an authorised repair shop to check the state of wear.
	Pressing collars [2] from 01-2012 ZB 203 ZB 303	3000 pressing operations, after one year at the latest	

ZB Adapter jaw

2.14.6 Maintenance and service plans for pressing tools

Maintenance and service plans for pressing tools with a mains connection

Pressing tools and pressing attachments that are not maintained, or are not professionally maintained, can cause serious accidents. The maintenance and service intervals as well as maintenance and service work described below must be followed.

Table 96: Maintenance and service plan for pressing tools with a mains connection and compatibility [2], [3]

	Pressing tool	In the range [MM/YY]	Interval	Work
User maintenance	All	—	Regularly (before use, at the start of the working day)	<ul style="list-style-type: none"> ▶ Check the pressing tool and mains cable or rechargeable battery for defects and damage that could affect safety. ▶ Clean and lubricate the pressing tool (see the operation manual).
	All	—	Every six months	<ul style="list-style-type: none"> ▶ Have a qualified electrician or an authorised repair shop carry out an inspection and take measurements to establish any defects or damage that could affect safety. ▶ Country-specific regulations can necessitate specific tests and maintenance work.
	EFP 2 [2]	01/05–06/16	Every six months or after 2500 pressing operations	<ul style="list-style-type: none"> ▶ Top up with gearbox grease (art. no. 90010).
Service by a repair shop	EFP 2 [2] ECO 201 [2]	01/05–06/16 02/01–03/11	Annually	<ul style="list-style-type: none"> ▶ Have an authorised repair shop check the pressing force and the state of wear.
	EFP 202 [2]	04/11–04/16	After 40,000 pressing operations or after 2 years at the latest in accordance with the information on the service sticker	
	ECO 202 [2]	04/11–04/16	After 40,000 pressing operations (interval is indicated by the red and green LEDs flashing alternately) or after 2 years at the latest in accordance with the information on the service sticker	
	ECO 203 [2] ECO 301 [3]	04/16–until now 01/05–03/19	If the red and green LEDs flash alternately or after 2 years at the latest in accordance with the information on the service sticker	
	EFP 203 [2]	04/16–until now	After 2 years in accordance with the information on the service sticker	

— Does not apply

i A service sticker on the pressing tool, pressing jaw, adapter jaw and pressing collar indicates the date when the next service is due.



Arrange for the pressing tool (type ACO pressing tools with a battery charger) to be sent for a service together with the pressing jaws, adapter jaws and pressing collars in the transport case.

i The addresses of authorised repair shops can be requested from the Geberit sales companies.

Maintenance and service plan for pressing tools with a rechargeable battery

Pressing tools and pressing attachments that are not maintained, or are not professionally maintained, can cause serious accidents. The maintenance and service intervals as well as maintenance and service work described below must be followed.

Table 97: Maintenance plan for pressing tools with a rechargeable battery and compatibility [1], [2], [2XL]

	Pressing tool	In the range [MM/YY]	Interval	Work
User maintenance	All	—	Regularly (before use, at the start of the working day)	<ul style="list-style-type: none"> ▶ Check the pressing tool and mains cable or rechargeable battery for defects and damage that could affect safety. ▶ Clean and lubricate the pressing tool (see the operation manual).
	All	—	Every six months	<ul style="list-style-type: none"> ▶ Have a qualified electrician or an authorised repair shop carry out an inspection and take measurements to establish any defects or damage that could affect safety. ▶ Country-specific regulations can necessitate specific tests and maintenance work.
Service by a repair shop	AFP 101 [1] ACO 201 [2]	07/06–04/12 04/11–04/16	Annually	<ul style="list-style-type: none"> ▶ Have an authorised repair shop check the pressing force and the state of wear.
	ACO 102 [1] ACO 202 [2]	04/12–04/18 04/11–04/16	After 40,000 pressing operations (interval is indicated by the red and green LEDs flashing alternately) or after 2 years at the latest in accordance with the information on the service sticker	
	ACO 103plus [1] ACO 203 [2] ACO 203plus [2] ACO 203XL [2]/[2XL] ACO 203XLplus [2]/[2XL]	04/18–until now 04/16–04/18 04/18–until now 01/05–03/19 04/18–until now	If the red and green LEDs flash alternately or after 2 years at the latest in accordance with the information on the service sticker	

— Does not apply

i A service sticker on the pressing tool, pressing jaw, adapter jaw and pressing collar indicates the date when the next service is due.



Arrange for the pressing tool (type ACO pressing tools with a battery charger) to be sent for a service together with the pressing jaws, adapter jaws and pressing collars in the transport case.

i The addresses of authorised repair shops can be requested from the Geberit sales companies.

2.15 COMMISSIONING

In addition to a professional installation, careful commissioning is required to ensure a perfect installation. The commissioning is regulated in the respective country-specific edition of EN 14336:2004 as well as in other country-specific regulations.

The commissioning includes the following subtasks:

- pressure test
- initial filling

After the commissioning, the operator assumes responsibility for the proper operation of the installation.

2.15.1 General pressure test

Unpressed and inadequately screwed connections can be identified by means of a pressure test before commissioning the system.

The contractor is obliged to carry out a pressure test before closing up the masonry slits, wall and ceiling openings, and (where applicable) before applying the screed or some other type of covering. The pressure test can be done on sections or on the complete system. A visual check must be carried out before the pressure test to check whether the system has been installed properly.

The pressure test consists of two steps in conditions similar to those during operation:

1. **leak test:** Checking the system for leaks. Unpressed and inadequately screwed connections can be identified in this way.
2. **load test:** Checking the system for the quality of the material and processing.

The commissioning of a system may only take place if the pressure test has been completed successfully. A successfully completed pressure test confirms to the customer that the pipe installation is leakproof and is to be documented with a test report.

2.15.2 Pressure test on drinking water installations

The pressure test checks the tightness of the pipe installation as well as the axial restraint of the connections. In principle, the local regulations and/or standards must always be taken into account during the pressure test.

When using handheld pressure test pumps, for example in the test version for performing a strength test with drinking water, it is important to ensure that the tools used are hygienically perfect. An appropriate measure is microfiltration of the test water before feeding it into the drinking water installation. The Geberit hygiene filter meets these requirements.

Carrying out a pressure test must be regarded as a binding component of the installation. The test must be documented, for example, by means of suitable protocols.

Pressure test using drinking water

The following basic rules must be observed for the pressure test with drinking water:

- The pressure test must be carried out directly before the commissioning for reasons of hygiene and chemical corrosion. If the commissioning is not carried out directly after the installation, the system must remain full and a water replacement of the entire drinking water installation must be carried out at regular intervals (at the latest after 7 days).
- Building heating must be provided for sub-zero ambient temperatures. Sub-zero temperatures do not warrant pressure testing with compressed air.
- Temperature compensation must be carried out so that the filling water can accommodate the ambient temperature. If the ambient temperature is higher than that of the filling water, the internal pressure rises due to the thermal expansion caused by the heating. Whereas, if the ambient temperature is lower than the temperature of the filling water, the internal pressure drops. A visual inspection must be carried out during the temperature compensation.
- The system must only be filled with hygienically perfect drinking water. If this is not possible, Geberit recommends using the Geberit hygiene filter.
- Pressure measuring or recording instruments must be installed at the lowest point of the drinking water installation.
- Pressure measuring instruments must be used for the pressure test, which clearly indicate changes in pressure of 0.1 bar.

Carrying out the pressure test with drinking water

- ✓ The adapter (outlet threaded nipple) is mounted on the test pipe.
- ✓ The Geberit hygiene filter is connected to the test pipe.
- ✓ The pressure test pump receptacle is filled with drinking water.

1 Seal the pipe ends, sanitary appliance and tap connectors with pressure test plugs.

2 Connect the hose of the pressure test pump to the Geberit hygiene filter.

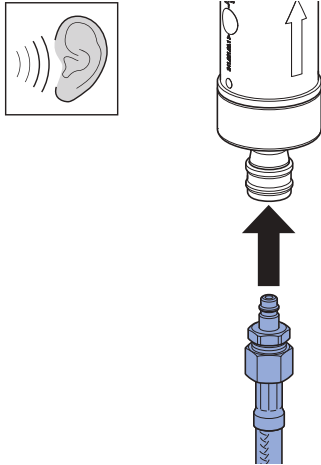

3 Connect the pressure test pump and pressure measuring instrument at the lowest point of the piping system to be tested through the Geberit hygiene filter.

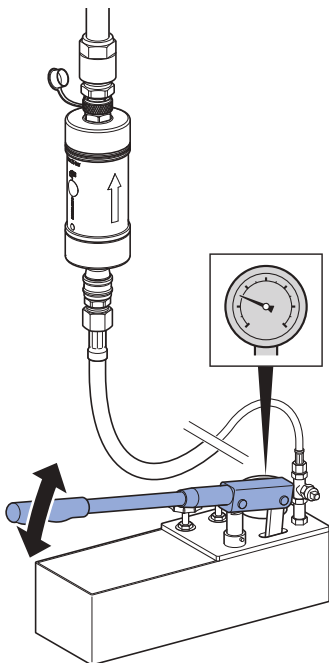

4 Fill the piping system slowly with drinking water and ventilate.

5 Slowly build up the pressure to 3 bar and maintain for 60 minutes in order to compensate for the temperature.

6 Set the pressure to 3 bar and test for 30 minutes for the leak test.

⇒ The pressure must be at least 2.5 bar after 30 minutes. If the pressure is < 2.5 bar, there are leaks in the piping system.

7 Check the tightness and insertion depth of all connections if the pressure is < 2.5 bar. Fix leaks.

-
- 8** Repeat the leak test until no more leaks can be detected.
-
- 9** For the strength test of the piping system, relieve the pressure from the leak test, do not empty.
-
- 10** Slowly build up the pressure to at least 15 bar or 1.5 times the operating pressure and test for 30 minutes. A maximum pressure of 15 bar is admissible for pure plastic installations or mixed installations.
- ⇒ The pressure must be at least 12 bar after 30 minutes. If the pressure is < 12 bar, there are leaks in the piping system that must be inspected and fixed.

2.15.3 Pressure testing of gas installations

In principle, the pressure test for gas installations can be performed using the following test media:

- oil-free compressed air
- inert gas (e.g. nitrogen)

Pressure test for natural gas installations

The pressure test for natural gas installations is recommended by Geberit. The pressure test for natural gas installations is carried out in accordance with the DVGW information sheet G 600, the one for liquefied gas installations according to TRF 1996.

A distinction is made between low pressure and medium pressure gas installations depending on the operating pressure.

The following test criteria apply for low pressure gas installations:

- Pipes with operating pressures of up to and including 100 mbar must undergo a load test and a leak test.
- The measuring instruments must have a minimum resolution of 100 mbar.

The following test criteria apply for medium pressure gas installations:

- Pipes with operating pressures ranging from 100 mbar to 1 bar must undergo a combined load and leak test.
- A Class 1 pressure recorder and a Class 0.6 manometer must be used as measuring instruments for the pressure test.

2.15.4 Rules for the pressure testing of heating and water heating installations

The following must be observed for the pressure testing:

- The contractor must carry out a pressure test on the system after installation and before closing up the masonry slits, wall and ceiling openings, and (where applicable) before applying the screed or some other type of covering.
- Water heating systems must be tested with a pressure that corresponds to the pressure of the relief valve.
- An additional visual check of each pressed joint is also used to check the axial restraint of the connections. It is therefore imperative to check whether a connection has been pressed (pressing indicator is no longer available).

2.15.5 Initial filling and flushing

The filling of a drinking water installation must only be carried out through a sufficiently flushed service connection pipe. The flushing of the service connection pipe must be carried out in accordance with the water supply specifications before the installation of the domestic water meter. It is important to ensure that there are sufficient drainage options.

The flushing of drinking water pipes may take place at least 72 hours before the intended operation of the installation according to SVGW Directive W3/E3, Edition 2018. The flushing process must be carried out separately for the cold and hot water installation. The initial filling and flushing must be documented.

The detailed process can be found in SVGW Directive W3/E3, Edition 2018. Suissetec also offers a corresponding protocol, which is available directly from suissetec.

Geberit International Sales AG

CH-8640 Rapperswil

Switzerland

sales@geberit.com

www.international.geberit.com